

Original operating instructions
Safety relay
with relay outputs
and muting function

UK

G2001S

11510711 / 00 01 / 2023

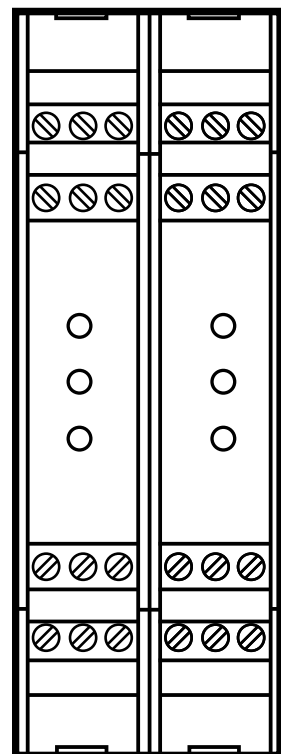

Contents

1	Preliminary note.....	4
1.1	Symbols used	4
1.2	Warning signs used	4
2	Safety instructions	4
3	Items supplied.....	5
4	Functions and features	6
4.1	Requirements for the hardware configuration	6
4.1.1	Product-independent requirements	6
4.1.2	Product-dependent requirements	6
5	Structure and operating principle.....	7
5.1	Connections and indicators	7
5.1.1	Connections.....	7
5.1.2	LED displays.....	7
5.1.3	LED states	8
6	Installation.....	9
7	Electrical connection.....	9
7.1	Supply voltage	9
7.2	Automatic or manual operation / feedback contacts	10
7.3	Muting.....	11
7.4	Timeout.....	12
7.5	Override	13
7.6	Safety light curtains / light grids	13
7.7	Output circuit.....	14
7.8	Overview.....	15
8	Operating modes	17
8.1	Automatic operation	17
8.2	Manual operation	17
8.2.1	Restart.....	17
8.3	K1/K2 feedback contacts	18
8.4	Muting.....	18
8.4.1	Alignment of 2 muting sensors	19
8.5	Override	21
8.5.1	Override with continuous command	21

8.5.2 Override with command pulse	22
9 Scale drawing	22
10 Technical data	23
11 Fault diagnoses	24
12 Maintenance, repair and disposal	25

1 Preliminary note

The instructions are part of the unit. They are intended for authorised persons according to the EMC and low voltage directives and safety regulations.

The instructions contain information about the correct handling of the product. Read the instructions before use to familiarise yourself with operating conditions, installation and operation.

Adhere to the safety instructions.

1.1 Symbols used

- ▶ Instruction
- > Reaction, result
- Cross-reference
- LED off
- LED on
- ⊗ LED flashes



Important note

Non-compliance can result in malfunctions or interference.



Information

Supplementary note.

1.2 Warning signs used

WARNING

Warning of serious personal injury.

Death or serious irreversible injuries may result.

2 Safety instructions

- Follow the operating instructions.
- In case of non-observance of instructions or standards, especially when tampering with and/or modifying the unit, any liability and warranty is excluded.
- The unit must be installed, connected and put into operation by a qualified electrician trained in safety technology.
- The applicable technical standards for the corresponding application must be complied with.

- For the installation the standards EN 60204, EN 999 and ISO 13855 have to be adhered to (the response times of all safety components have to be observed).
- In case of malfunction of the unit please contact the manufacturer. Tampering with the unit is not allowed.
- Disconnect the unit externally before handling it. Also disconnect any independently supplied relay load circuits.
- After setup the system has to be subjected to a complete function check.
- Use the unit only in specified environmental conditions (→ 10 Technical data). In case of special operating conditions please contact the manufacturer.

UK

⚠ WARNING

In case of improper handling of the product, the safety and physical integrity of operators and machinery cannot be guaranteed.

Death or serious irreversible injuries may result.

- ▶ Observe all notes on installation and handling in these instructions.
- ▶ The safety relay must only be used under the specified operating conditions and in accordance with use as prescribed below.

3 Items supplied

- 1 G2001S safety relay
- 1 copy of the operating instructions safety relay, reference 80302301.

If one of the above-mentioned components is missing or damaged, please contact one of the ifm branch offices.

4 Functions and features

The G2001S safety relay is a redundant system and suited for use as muting relay in conjunction with 2 muting sensors.



ifm electronic gmbh assumes no liability for the use of units made by external manufacturers.



The safe state is when the output contacts (12/22 or 23/24) are open.

4.1 Requirements for the hardware configuration

The following requirements must be met when using the G2001S safety relay:

4.1.1 Product-independent requirements

It must be ensured that the safety requirements of the respective application correspond to the requirements stated in these instructions.

The specified technical data indicated in these instructions must be complied with.

4.1.2 Product-dependent requirements

The safety relay is only to be used for muting applications in conjunction with safety light curtains / light grids.

The response times of all safety components are to be considered (e.g. safety light curtains / light grids).

In case of faults within the safety relay which result in the defined safe state, the safety relay must be replaced.

Any faulty unit should be returned to the manufacturer.

5 Structure and operating principle

5.1 Connections and indicators

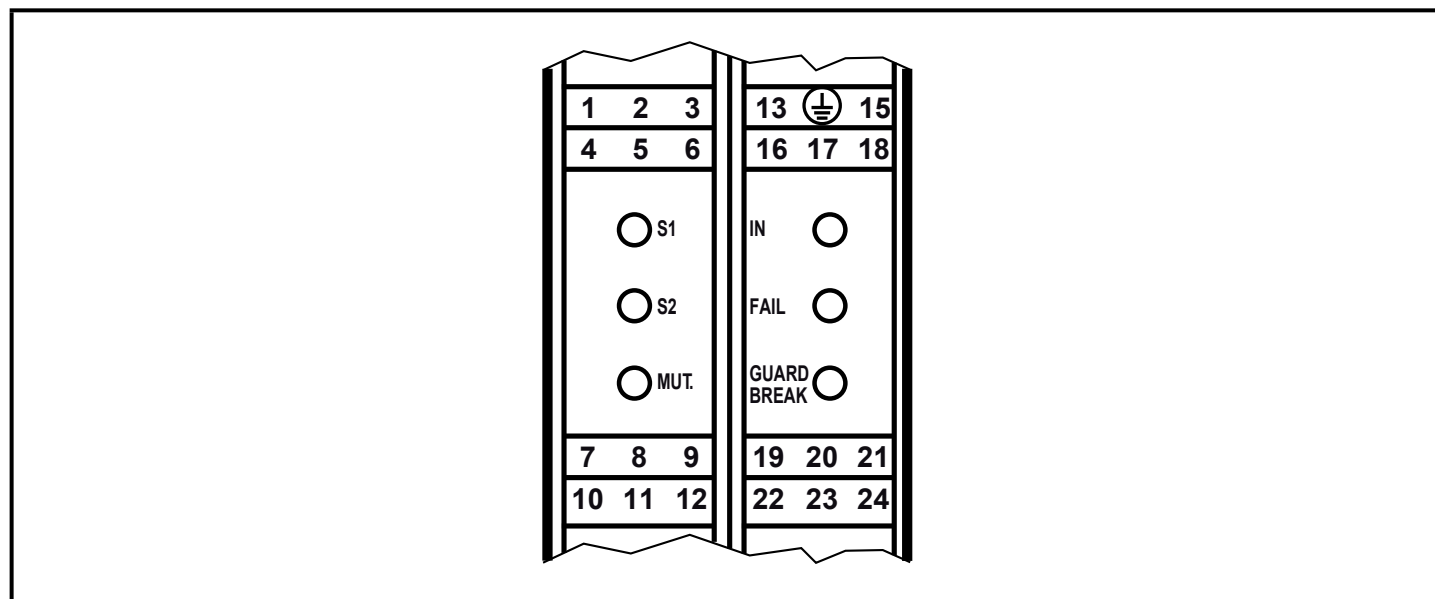

UK

5.1.1 Connections

1	Muting sensor S1	13	Supply voltage L-
2	Muting sensor S2	14	PE (GND)
3	Supply voltage L+	15	Restart
4	Timeout 1	16	n. c.
5	Timeout 2	17	Input OSSD 1
6	Operating mode MAN/AUTO	18	Input OSSD 2
7	Override 1	19	n. c.
8	Override 2	20	Feedback contact K1/K2
9	n. c.	21	Auxiliary output — —
10	Muting lamp	22	Relay output R2 — —
11	Muting activation	23	Relay output R1 — —
12	Relay output R2 — —	24	Relay output R1 — —

5.1.2 LED displays

S1	yellow	status muting sensor S1	IN	green	status OSSDs
S2	yellow	status muting sensor S2	FAIL	red	failure
MUT.	yellow	muting status	GUARD BREAK	green / red / yellow	status relay output R1/R2

5.1.3 LED states

Description	<table border="1" style="display: inline-table; vertical-align: middle;"> <tr> <td><input type="radio"/> S1</td> <td>IN</td> <td><input type="radio"/></td> </tr> <tr> <td><input type="radio"/> S2</td> <td>FAIL</td> <td><input type="radio"/></td> </tr> <tr> <td><input type="radio"/> MUT.</td> <td>GUARD BREAK</td> <td><input type="radio"/></td> </tr> </table>	<input type="radio"/> S1	IN	<input type="radio"/>	<input type="radio"/> S2	FAIL	<input type="radio"/>	<input type="radio"/> MUT.	GUARD BREAK	<input type="radio"/>	LED		
		<input type="radio"/> S1	IN	<input type="radio"/>									
<input type="radio"/> S2	FAIL	<input type="radio"/>											
<input type="radio"/> MUT.	GUARD BREAK	<input type="radio"/>											
		S1 yellow	S2 yellow	MUT. yellow									
Switch-on test		●	●	●									
Object detected		●	●	○									
No object detected		○	○	○									
Muting active		●	●	●									
Override request		● / ○	● / ○	⊗									

Description	<table border="1" style="display: inline-table; vertical-align: middle;"> <tr> <td><input type="radio"/> S1</td> <td>IN</td> <td><input type="radio"/></td> </tr> <tr> <td><input type="radio"/> S2</td> <td>FAIL</td> <td><input type="radio"/></td> </tr> <tr> <td><input type="radio"/> MUT.</td> <td>GUARD BREAK</td> <td><input type="radio"/></td> </tr> </table>	<input type="radio"/> S1	IN	<input type="radio"/>	<input type="radio"/> S2	FAIL	<input type="radio"/>	<input type="radio"/> MUT.	GUARD BREAK	<input type="radio"/>	LED				
		<input type="radio"/> S1	IN	<input type="radio"/>											
<input type="radio"/> S2	FAIL	<input type="radio"/>													
<input type="radio"/> MUT.	GUARD BREAK	<input type="radio"/>													
		IN green	FAIL red	GUARD/BREAK											
				red	yellow	green									
Switch-on test		●	●	●	○	○									
Protected area interrupted, relay outputs deactivated		○	○	●	○	○									
Protected area clear, relay output deactivated, waiting for restart		●	○	●	●	○									
Protected area clear, relay outputs activated		●	○	●	○	●									

6 Installation

Mount the unit on a DIN rail in a housing protected against dust and humidity (min. IP 54 - degree of soiling 2).

Leave enough space between the unit and the top and bottom of the housing to enable air circulation and to avoid excessive heating.

Take into account the internal heating of all units when mounting several units side by side. The environmental conditions must be observed for every unit.

7 Electrical connection

► Disconnect power. Also disconnect any independently supplied relay load circuits.

 Note: Lay the safety relay cables separately from sources of interference such as power lines.

Connection cables between safety relay and safety light curtains /light grids of a length of more than 50 m must have a cross-section of min. 1 mm².

 The safety relay is only to be used for muting applications in conjunction with safety light curtains / light grids.

7.1 Supply voltage

 The nominal voltage is 24 V DC. This voltage may vary between 19.2 V and 28.8 V incl. 5% residual ripple. SELV /PELV power supplies are to be used.

Connect supply voltage

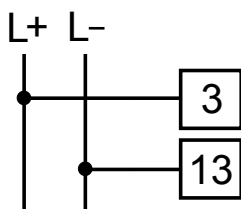

Manual reset

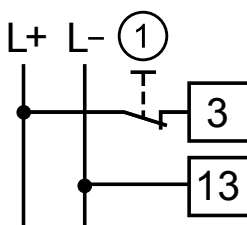

For safety reasons the unit can only be restarted by separation from the supply voltage in case of a fault. It is thus recommended to install a reset button in series with the L+ circuit.

1: Reset

After power on or a reset the unit carries out self diagnostic functions. After this self diagnosis the unit is ready for operation.

7.2 Automatic or manual operation / feedback contacts

Automatic operation

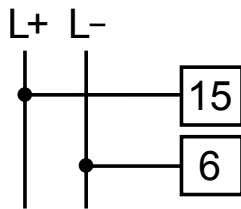

Automatic activation without monitoring.

Automatic operation with monitoring of the feedback contacts

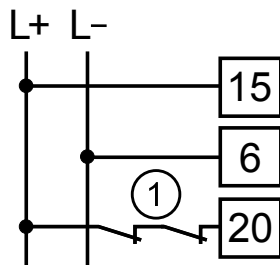

Release is made when the feedback contacts are closed.
Consider the current flowing through the feedback contacts (→ 10 Technical data).

1: Feedback contacts

Manual operation

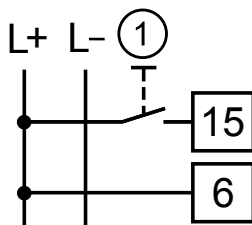

Activate the relay outputs:

► Press and release restart (> 100 ms).

1: Restart

Manual operation with monitoring of the feedback contacts

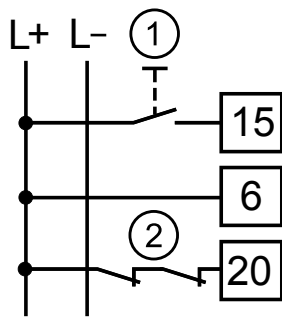

Activate the relay outputs:

The feedback contacts are closed

► Press and release restart (> 100 ms).

Consider the current flowing through the feedback contacts (→ 10 Technical data).

1: Restart

2: Feedback contacts

UK

► If no feedback contacts are used, connect terminals 20 and 21.

7.3 Muting

Connection of 2 muting sensors

Muting sensor S1

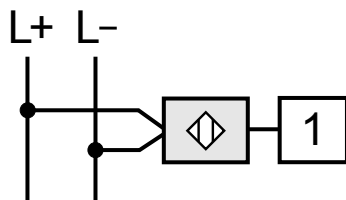

Muting sensor S2

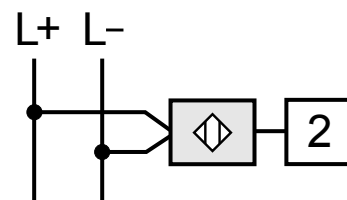

Alignment of the muting sensors → 8.4.1

Muting lamp

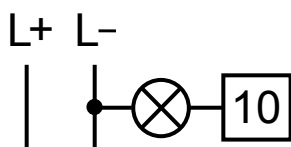

Prerequisite for the muting function is the connection of a muting lamp (0,5...5 W).

Muting activation

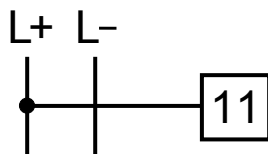

To start the muting function a high signal (24 V) has to be applied to terminal 11.

A continuous signal or a pulse > 1 s can be used.

7.4 Timeout

Timeout is a time limit of the muting function.

Timeout 30 seconds

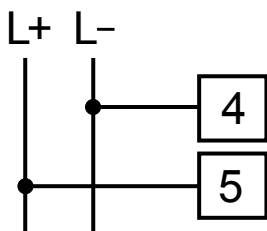

The muting function ends after 30 s.

Unlimited timeout

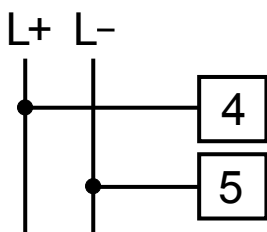

When the muting function has started it is available for an unlimited period of time as long as the muting sensors detect an object.



If unlimited timeout is used, additional measures are to be taken to avoid a permanent muting function.

7.5 Override



Do not short-circuit terminals 7 and 8.

Override with continuous command

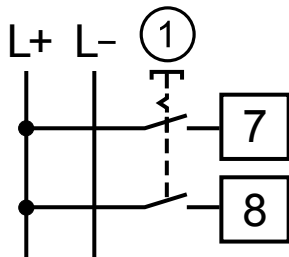

► Use a key-operated switch with spring return. The command pulse must be applied simultaneously to both terminals within 400 ms.

1: Key-operated switch

Override with command pulse

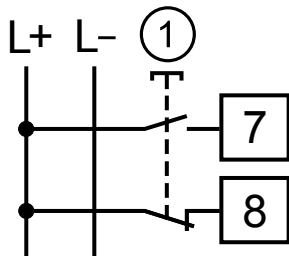

The command pulse must invert the condition of terminals 7 and 8 within 400 ms.

1: Override button

7.6 Safety light curtains / light grids



Do not short-circuit terminals 17 and 18.

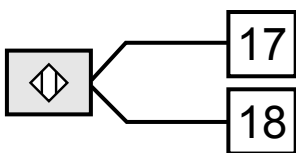

► Connect the OSSD signals to terminals 17 and 18.

7.7 Output circuit

Connect the load

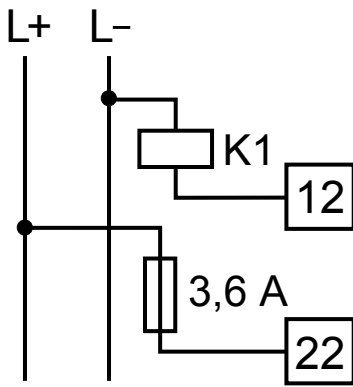

- ▶ Connect the load to be controlled to the relay outputs 23/24 or 12/22.

For the output circuit, the G2001S uses two guided contact safety relays.

- ▶ Protect the output contacts with a slow-acting 3,6 A fuse.

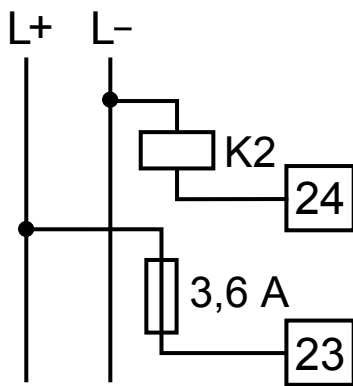

Check if the loads correspond to the values in the table below.

Min. voltage	> 18 V DC
Min. current	> 20 mA
Max. voltage	< 250 V AC
Max. current	< 2 A

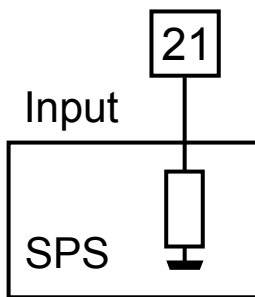

The auxiliary output (terminal 21) provides a non safety-related signal for communication to a PLC. The signal corresponds to the relay outputs 23/24 or 12/22.



Check the proper function of the entire safety system (safety relay and safety light curtains / light grids) after electrical connection.

- ▶ Interrupt the protected area of the safety light curtain / light grid
 - > Relay outputs of the G2001S drop out
 - 5.1.3 LED states (GUARD/BREAK)

7.8 Overview

Automatic operation with monitoring of the feedback contacts and timeout 30 s

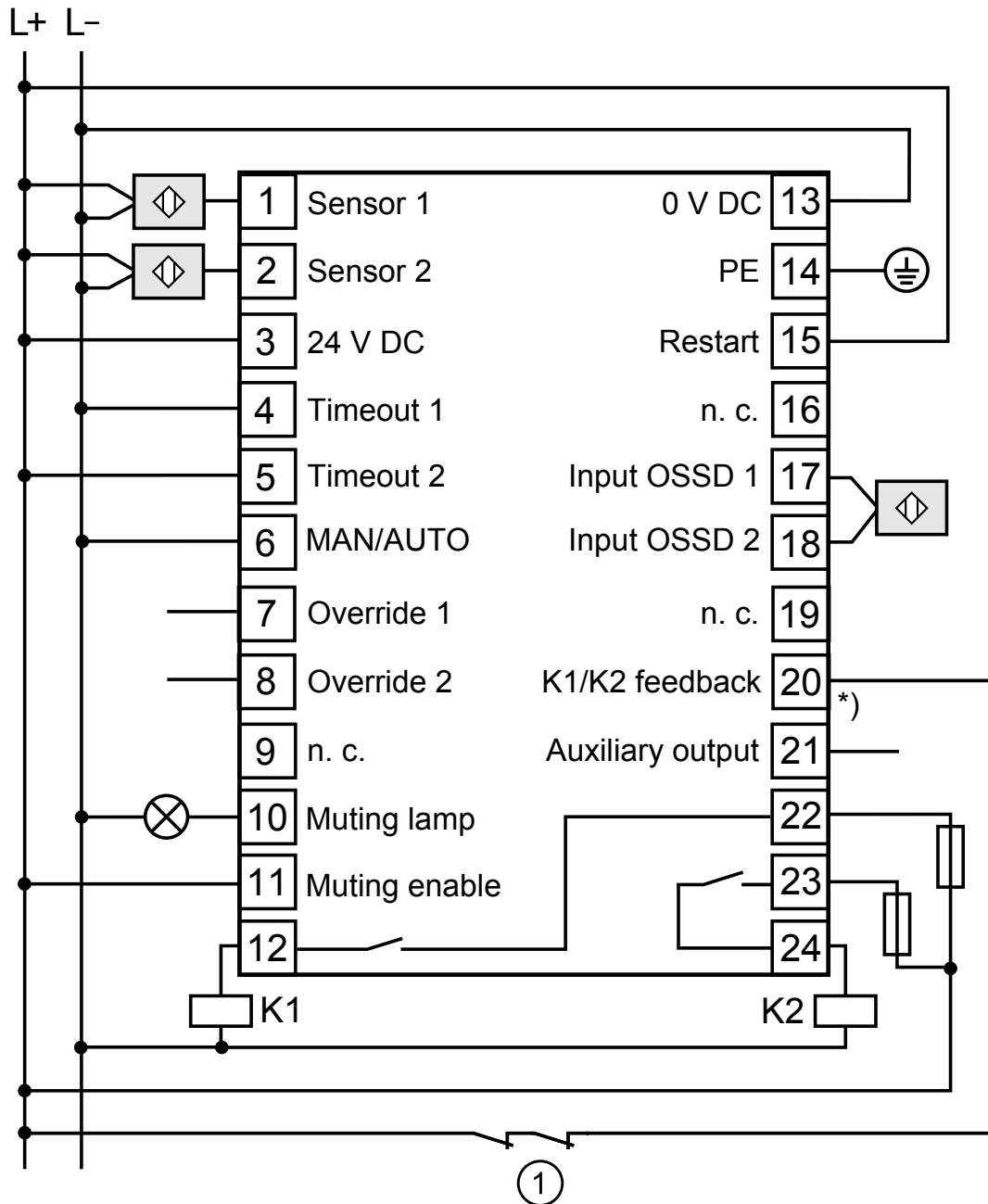

1: K1/K2 feedback contacts

*) If no feedback contacts are used, connect terminals 20 and 21.

Manual operation with monitoring of the feedback contacts and timeout 30 s

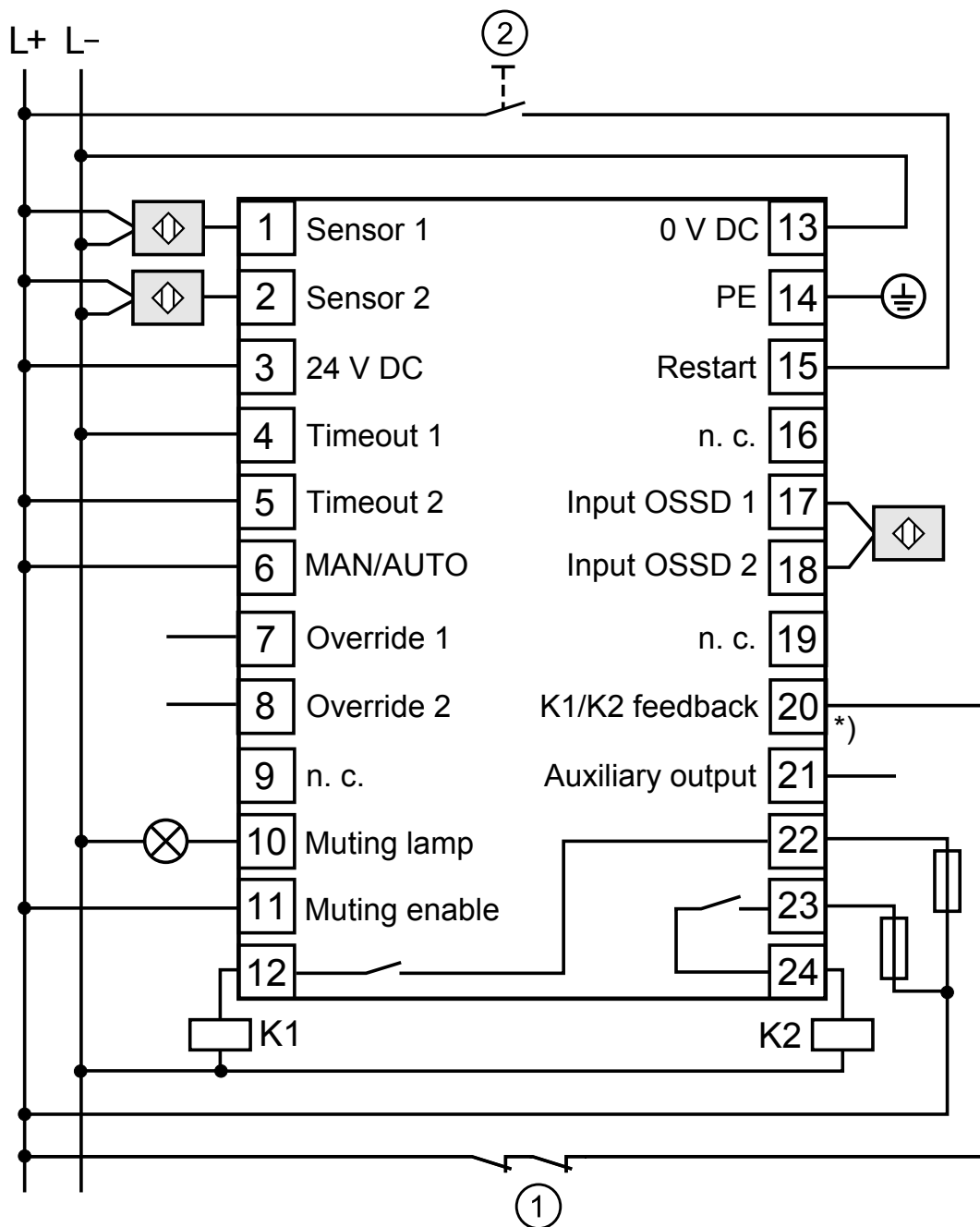

1: K1/K2 feedback contacts

2: Restart button

*) If no feedback contacts are used, connect terminals 20 and 21.

8 Operating modes



After new installation or change of the operating mode check the function of the entire safety system (safety relay and safety light curtains / light grids).

8.1 Automatic operation

If the safety relay is used in the automatic mode, monitored start is not possible.

The safety light curtains / light grids automatically return to operation if the protected area is clear, the relay outputs (OSSDs) are activated.



Verify if this is compatible with your machine.

UK

In the automatic mode the relay 1 and relay 2 outputs follow the status of the safety light curtains / light grids:

Protected area clear	Relay outputs = active logic "1"
Protected area interrupted	Relay outputs = deactivated logic "0"

8.2 Manual operation

Operation in the manual mode is always necessary when passage to a hazardous area is to be monitored (persons can be present in the hazardous area after accessing the protected area without being detected).

The relay 1 and relay 2 outputs become active when the protected area is clear and restart is activated via a restart button or via a respective pulse (> 100 ms) on the input of terminal 15.

If the safety light curtains / light grids are activated by a person or an object, a restart is always necessary for the release.

8.2.1 Restart

The restart button has to be outside the hazardous area It has to be installed so that the hazardous area and access can be clearly seen. It must not be possible to activate the restart button from within the hazardous area.

The restart time of the safety relay is 100 ms. Also take into account the restart times of the external contactors.

8.3 K1/K2 feedback contacts

External contactors can be integrated into the automatic or manual operation. They must be connected to terminal 20 (K1/K2 feedback contact).

For loads of voltages and currents higher than those indicated in the following table external contactors or auxiliary relays should be used in accordance with the loads to be switched. Safety elements with positively guided contacts are to be used.

Min. voltage	≥ 18 V DC
Min. current	≥ 20 mA
Max. voltage	≤ 250 V AC
Max. current	≤ 2 A

If no external contactors are used, the terminals 20 (K1/K2 feedback contact) and 21 (auxiliary output) must be interconnected.

The auxiliary contacts of K1 and K2 must be able to switch a current of 20 mA and a voltage of 24 V DC.

Suitable interference suppressors on the coil end of K1 and K2 prolong the life of the internal relays.

8.4 Muting

Muting is the temporary suspension of the protective function of safety light curtains / light grids to transport objects through a hazardous area as planned. The muting sensors detect objects before they enter the protected area and enable a distinction between man and material after correct optical alignment.



Check if this function is compatible with the risk analysis of your machine and if additional measures have to be taken.

The following components are necessary for the muting function:

- G2001S safety relay
- safety light curtain / safety light grid
- 2 muting sensors
- muting lamp (0,5...5 W)

To start the muting function a high signal (24 V) must be applied to terminal 11 (muting activation) for 1 s.



Correct alignment of the muting sensors is imperative for the proper function of the safety relay.

8.4.1 Alignment of 2 muting sensors

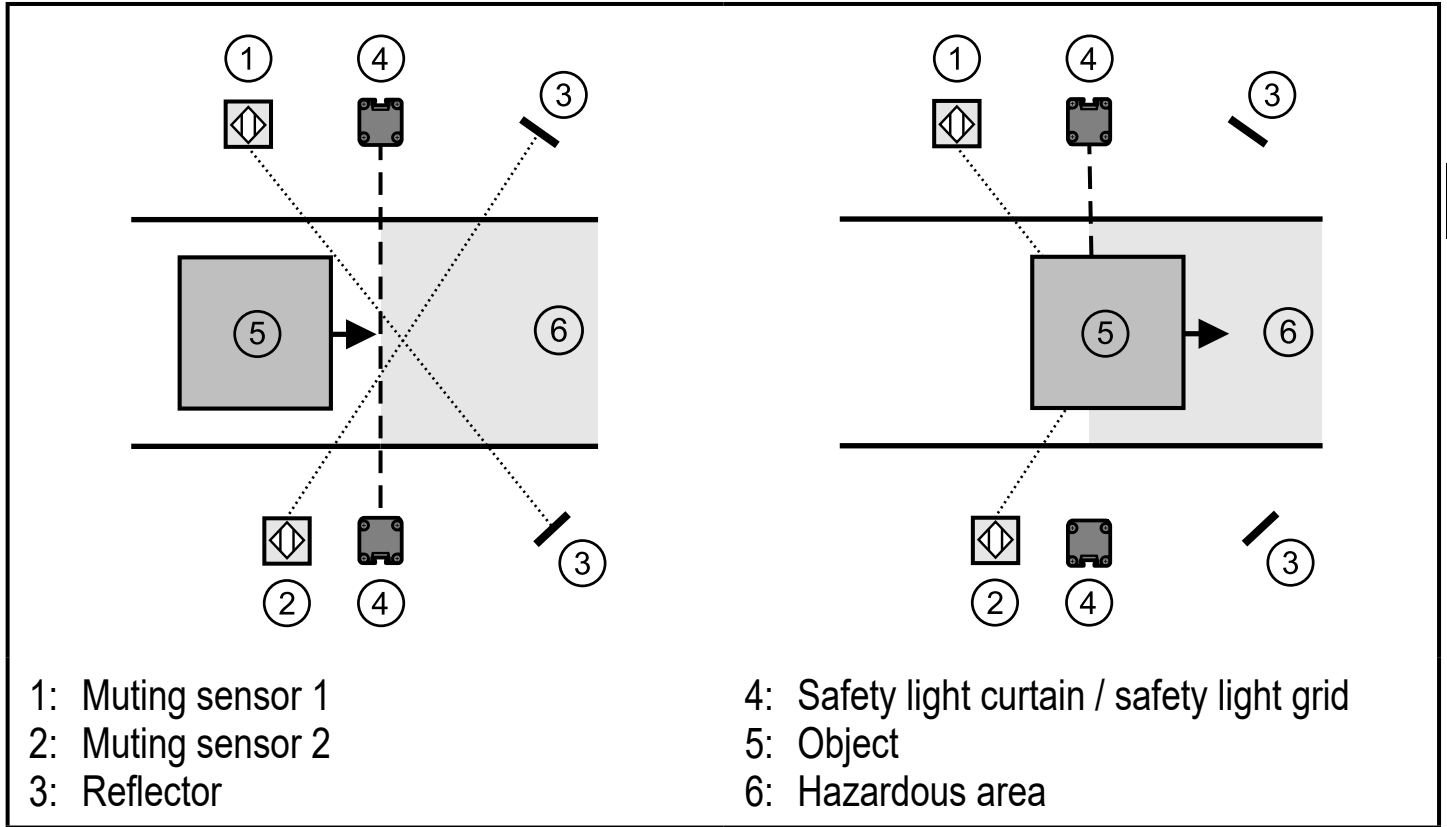

- Align the muting sensors so that they can detect objects before they enter the hazardous area.
- If an object is detected by both muting sensors S1 and S2 within 4 s, the muting function is active and the object can travel through the hazardous area.
- Both muting sensors must carry a high signal (24 V) while the muting function is active.

Muting ends with one of the following conditions:

- after release of one of the two muting sensors
- when the time limit of 30 s has elapsed (timeout)

UK

Muting ends after release of the muting sensors

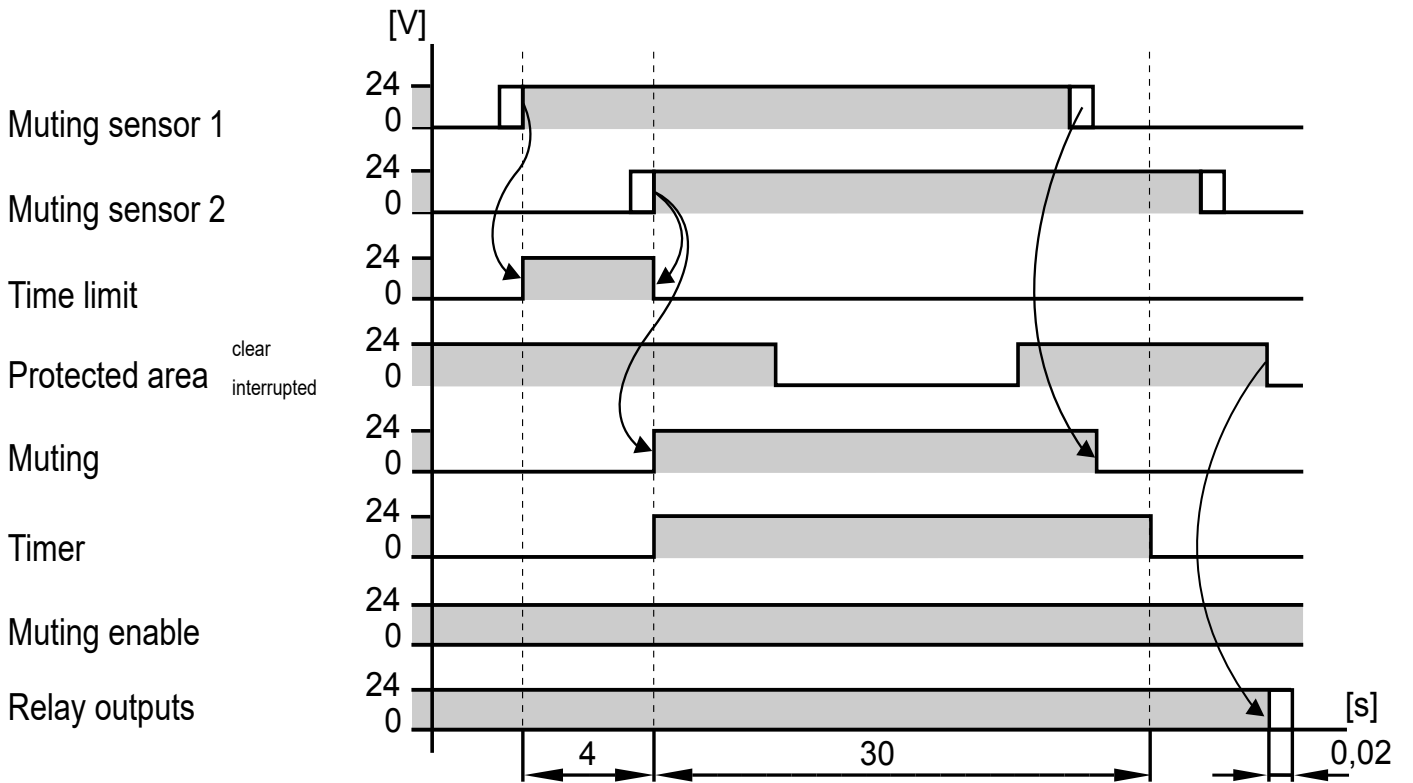

Muting ends after the time limit (timeout 30 s) has elapsed

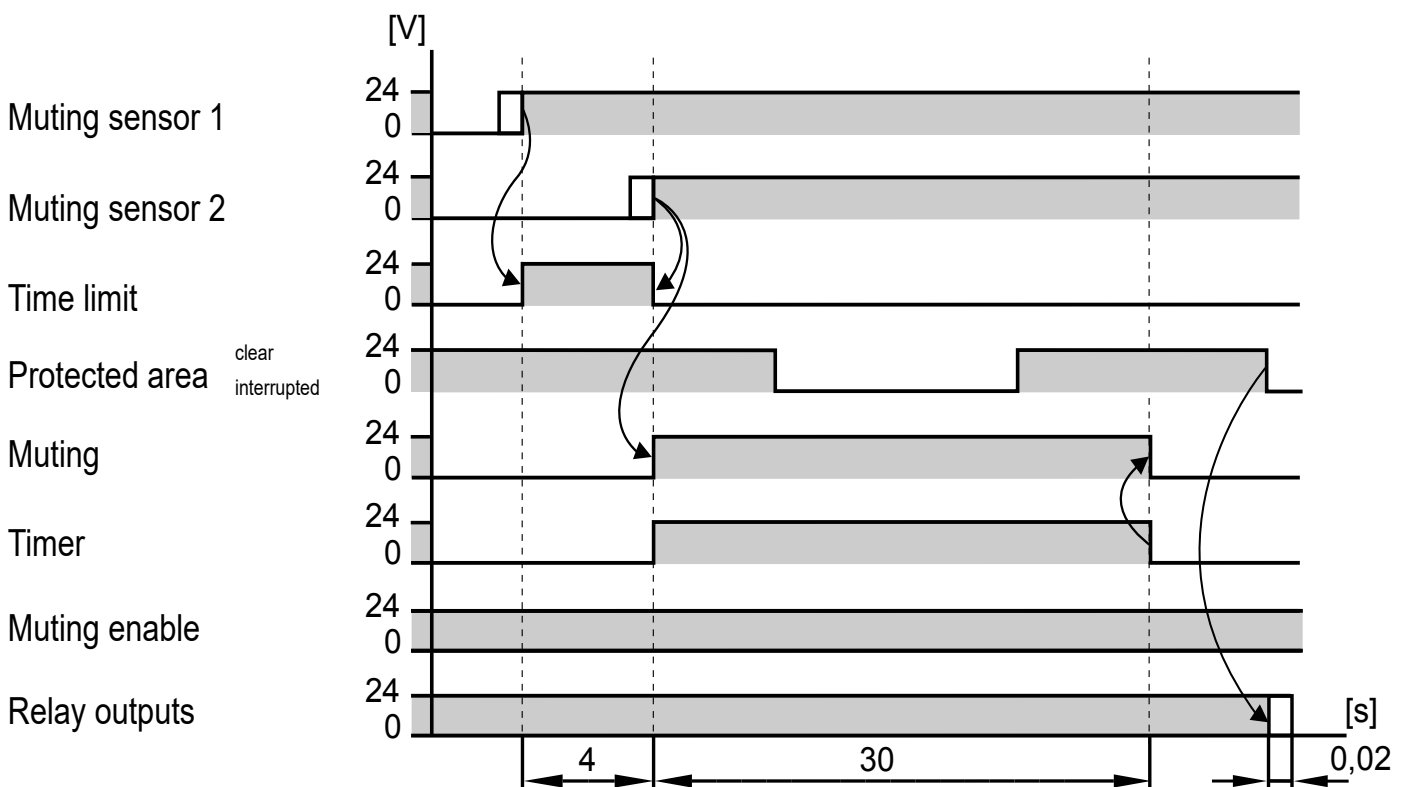

8.5 Override

Override means suspension of the safety function. It ensures a controlled restart to transport jammed material out of the protected area.

WARNING

During the whole override function access to the hazardous area is not protected by the safety light curtains / light grids.

Death or serious irreversible injuries may result.

▶ Mind the dangers in the hazardous area.

When the override function is active, the OSSD outputs of the safety light curtains / light grids are inactive and/or at least one muting sensor detects an object.

The MUT. LED lights during the whole override function (→ 5.1.2 LED displays)



Regularly check the function of the LED displays.

The following types of override can be configured:

- override with continuous command
- override with command pulse

8.5.1 Override with continuous command

▶ Activate key-operated switch

> Bridging the safety light curtains / light grids for max. 15 min.

The override function ends with the following conditions:

- key-operated switch activated again.
- 15 min. have elapsed.
- protected area clear and muting sensors free.

The GUARD function is activated without further commands.

8.5.2 Override with command pulse

► Press override button

> Bridging the safety light curtains / light grids for max. 15 min.

The function can be started again by activating the override button at the following conditions:

- max. 30 subsequent override command pulses
- max. total time of the override function = 60 min.

The override function ends automatically with clear protected area and free muting sensors or when the 15 min have elapsed and the GUARD function will be activated without any further command.

The timer for the override command pulses and the total time of the override function will be reset to 0.

9 Scale drawing

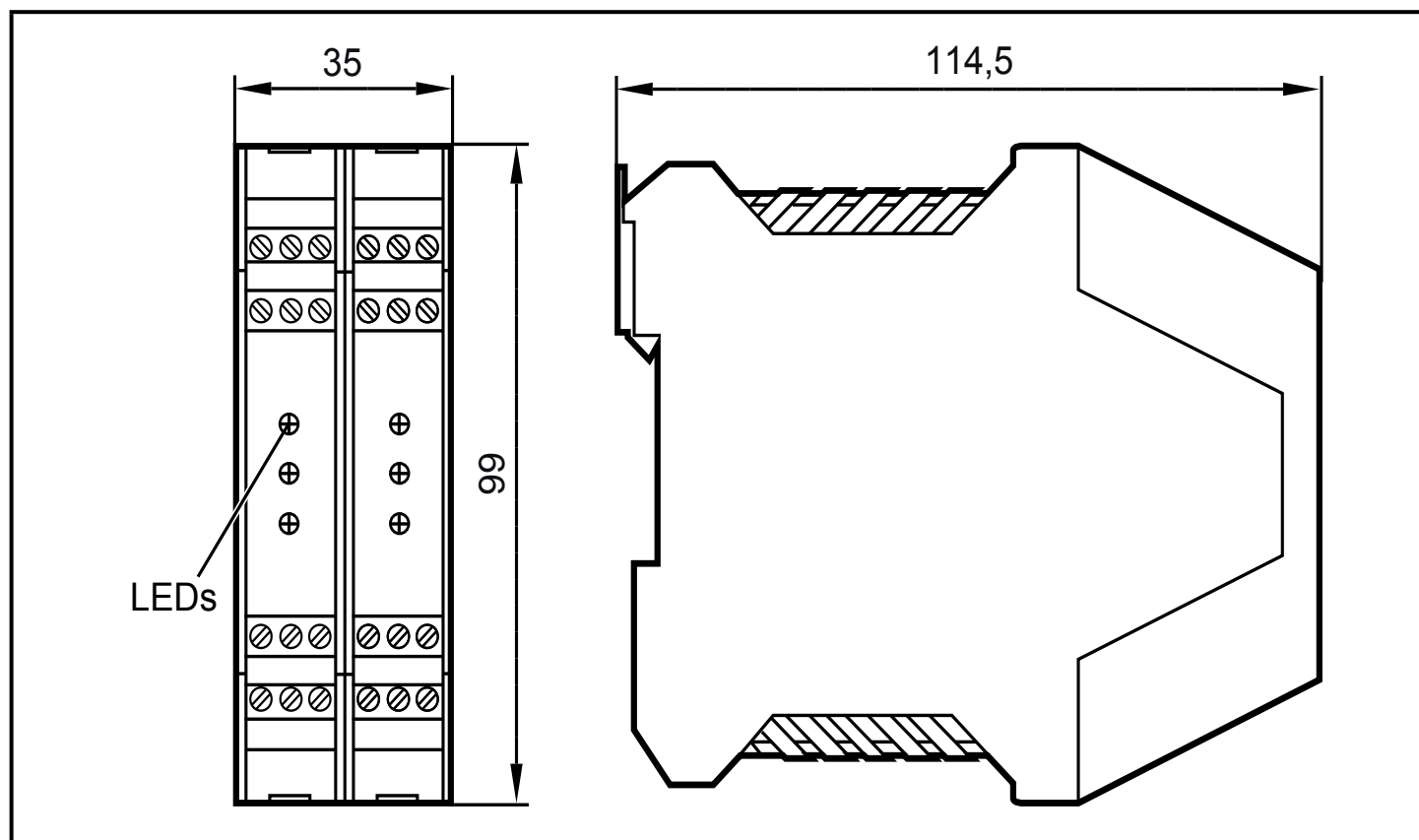

10 Technical data

G2001S

Safety relay with relay outputs

Meets the requirements of:

EN ISO 13849-1 (2015) category 4 PL e, SIL 3 (IEC 61508), SIL_{CL} 3 (IEC 62061)

Electrical design	relay
Output function	2 safety-related normally open contacts (floating contacts, 2 A / 250 V); 1 signal output (PNP, 100 mA (24V))
Operating voltage	24 V DC (19.2...28.8)
Contact rating	2 A / 250 V AC / 24 V DC (≥ 20 mA)
Short-circuit protection / overload protection	*) no
Current consumption	208 mA (24 V)
Safety light curtains / light grids to be connected	1 (with OSSD outputs)
Input muting sensors	2 sensors (24 V DC, PNP, dark-on mode)
Input muting activation	24 V DC, PNP
Output muting lamp	24 V DC / 0,5...5 W
Power-on delay time	< 12 s
Response time on safety request	20 ms
Min. load current of the feedback contacts	20 mA (24 V)
Current rating auxiliary output (terminal 21)	max. 100 mA (20 °C)
Ambient temperature	0...55°C
Protection rating	IP 20
Housing materials	PA
Mission Time (TM)	175200 h
Safety-related reliability PFH	7,0 ⁻⁹ / h
MTTF _d	100 years
DC / CCF / Cat.	96 % / 80 % / 4
Switching operations	800.000 (2 A (230 V AC) / 0,5 A (24 V DC))

*) The contacts are to be protected by means of fuses with a nominal current of < 3.6 A.

11 Fault diagnoses

In the event of malfunctions of the module or faulty electrical connections possible causes can be detected by means of flash pulses.



In case of a fault switch the safety relay off and on again!

Description	<table border="1" style="display: inline-table; vertical-align: middle;"> <tr> <td><input type="radio"/> S1</td> <td>IN</td> <td><input type="radio"/></td> </tr> <tr> <td><input type="radio"/> S2</td> <td>FAIL</td> <td><input type="radio"/></td> </tr> <tr> <td><input type="radio"/> MUT.</td> <td>GUARD BREAK</td> <td><input type="radio"/></td> </tr> </table>	<input type="radio"/> S1	IN	<input type="radio"/>	<input type="radio"/> S2	FAIL	<input type="radio"/>	<input type="radio"/> MUT.	GUARD BREAK	<input type="radio"/>	LED			
		<input type="radio"/> S1	IN	<input type="radio"/>										
<input type="radio"/> S2	FAIL	<input type="radio"/>												
<input type="radio"/> MUT.	GUARD BREAK	<input type="radio"/>												
	S1 yellow	S2 yellow	MUT. yellow	pulses										
Wrong connection or muting lamp missing	○	○	⊗	2										
Wrong configuration or muting timeout exceeded	○	○	⊗	3										
Fault of the external relay K1/K2	○	○	⊗	4										
Error muting sensor	● / ○	● / ○	⊗	5										
Override with command pulse not available	⊗	⊗	⊗	6										

Description	<table border="1" style="display: inline-table; vertical-align: middle;"> <tr> <td><input type="radio"/> S1</td> <td>IN</td> <td><input type="radio"/></td> </tr> <tr> <td><input type="radio"/> S2</td> <td>FAIL</td> <td><input type="radio"/></td> </tr> <tr> <td><input type="radio"/> MUT.</td> <td>GUARD BREAK</td> <td><input type="radio"/></td> </tr> </table>	<input type="radio"/> S1	IN	<input type="radio"/>	<input type="radio"/> S2	FAIL	<input type="radio"/>	<input type="radio"/> MUT.	GUARD BREAK	<input type="radio"/>	LED			
		<input type="radio"/> S1	IN	<input type="radio"/>										
<input type="radio"/> S2	FAIL	<input type="radio"/>												
<input type="radio"/> MUT.	GUARD BREAK	<input type="radio"/>												
	IN green	FAIL red	GUARD/BREAK red	pulses										
Internal fault	○	●	⊗	2										
Fault of the internal relay	○	●	⊗	3										
Fault of the external relay K1/K2	○	●	⊗	4										
Wrong output configuration	○	●	⊗	5										
Configuration changed without restart ▶ make a restart	○	●	⊗	6										
Possible overload or wrong connection of the auxiliary output	○	●	⊗	7										



If the fault cannot be eliminated, switch off the entire machine and contact the ifm service hotline.

12 Maintenance, repair and disposal

- Only the manufacturer is allowed to repair the unit.
- After use dispose of the unit in an environmentally friendly way in accordance with the applicable national regulations.