

80293147 / 00 10 / 2020

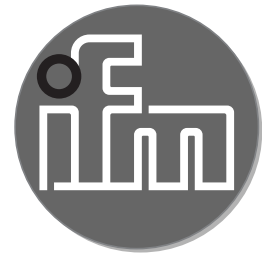

Operating instructions IO-Link module

UK

AL2201
AL2301
AL2203
AL2303
AL2205
AL2605

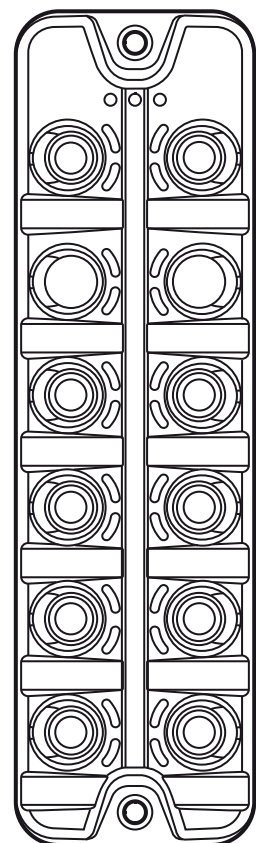

Contents

1 Preliminary note.....	4
2 Safety instructions	4
3 Functions and features	4
3.1 IO-Link	5
3.1.1 General information	5
3.1.2 Device-specific information.....	5
3.1.3 Response when the IO-Link communication is interrupted	5
4 Function.....	6
4.1 Versions	6
4.2 Electrical isolation of the voltage supply.....	6
4.3 Visual indication.....	6
4.4 Parameter setting	7
4.5 Inputs/outputs	7
4.6 Voltage supply	7
4.6.1 US supply voltage.....	7
4.6.2 UA voltage supply.....	7
4.6.3 UAI sensor supply.....	7
4.6.4 Behaviour in case of undervoltage	8
4.6.5 Limit values, protection against excessive current	8
4.6.6 Derating (AL2605)	8
4.7 Digital input filters	9
4.7.1 Debounce	11
4.7.2 Hold	12
4.7.3 Invert.....	12
4.7.4 Combination of different input filters	13
4.8 Analogue input signals.....	13
5 Installation.....	14
6 Electrical connection.....	14
6.1 IO-Link connection.....	14
6.2 Input circuit	15
6.3 Pin connection	15
7 Operating and display elements	17
7.1 AL2x01, AL2x03.....	17

7.2 AL2x05.....	18
7.3 LEDs.....	19
8 Scale drawing.....	20
8.1 AL2x01, AL2x03.....	20
8.2 AL22x5.....	21
8.3 AL26x5.....	22
9 Technical data.....	23
10 Maintenance, repair and disposal.....	23
10.1 Cleaning the housing surface.....	23
11 Approvals/standards.....	23

1 Preliminary note

▶ Instruction

> Reaction, result



Important note

Non-compliance may result in malfunction or interference.



Information

Supplementary note

2 Safety instructions

- Please read the operating instructions prior to set-up of the device. Ensure that the product is suitable for your application without any restrictions.
- The unit complies with the relevant regulations and EU directives.
- Improper or non-intended use may lead to malfunctions of the unit or to unwanted effects in your application.
- Installation, electrical connection, set-up, operation and maintenance of the unit must be carried out by qualified personnel authorised by the machine operator.

3 Functions and features

The unit has 8 multiports which can be used as follows:

- digital input
- analogue input
 - 4...20 mA
 - 0...10 V
- digital output

The AL220x device has a grey housing and is suitable for use in the food and beverage industry (use of cleaning agents at high pressure and high temperatures).

The AL230x and AL2605 devices (orange) must not be used in these areas.

3.1 IO-Link

3.1.1 General information

This unit has an IO-Link communication interface which enables direct access to process and diagnostic data. In addition it is possible to set the parameters of the unit while it is in operation. Operation of the unit via an IO-Link interface requires an IO-Link capable module (IO-Link master).

3.1.2 Device-specific information

With a PC, suitable IO-Link software and an IO-Link adapter cable, communication is possible while the system is not in operation. The IODDs necessary for the configuration of the unit, detailed information about process data structure, diagnostic information, parameter addresses and the necessary information about the required IO-Link hardware and software can be found at www.ifm.com.

Two different IODDs are available for this unit. One for port configuration by means of process data (PDout), the other for configuration via acyclic communication. By default, the module is configured for cyclic parameter setting.

3.1.3 Response when the IO-Link communication is interrupted

The parameter "Output state COM lost / PD invalid" (index 15000) is used to set how the outputs are to respond when the IO-Link communication is interrupted. For every output it can be defined separately if it:

- is to be switched on (HIGH)
- is to be switched off (LOW)
- or is to keep the last state

4 Function

After power on, the unit is in the RUN mode (normal operating mode).

4.1 Versions

The following versions are available:

Version	Device	Device-ID	Description	Application
1 (Default)	AL2201 AL2301	1407 d / 00 05 7F h	Parameter setting by means of cyclical process data	Parameter setting via controller
	AL2203 AL2303	1405 d / 00 05 7D h		
	AL2205 AL2605	1315 d / 00 05 23 h		
2	AL2201 AL2301	1408 d / 00 05 80 h	Parameter setting via acyclic communication	Parameter setting with IO-Link software
	AL2203 AL2303	1406 d / 00 05 7E h		
	AL2205 AL2605	1316 d / 00 05 24 h		

4.2 Electrical isolation of the voltage supply

The voltage supply of the ports (UA and UAi) is electrically isolated from the voltage supply of the IO-Link master (US).



An electrical connection between US and UAi eliminates the electrical isolation. This can lead to increased interference in the IO-Link communication.

4.3 Visual indication

The unit signals

- the current physical state of the inputs/outputs (yellow LED I/O1 and I/O2)
- error-free operation (green LEDs US, UA and UAi light, red LEDs INT, 1 and 2 are off)
- a short circuit of min. one sensor supply
 - of port group 1 (X1.0...X1.3 --> LEDs I/O 1 flash, red LED 1 on)
 - of port group 2 (X1.4...X1.7 --> LEDs I/O 2 flash, red LED 2 on)
- an internal fault (red LED INT on)

4.4 Parameter setting

Device-specific parameter lists for IO-Link parameter setting are available at www.ifm.com.

4.5 Inputs/outputs

The unit has 8 ports (X1.0...X1.7). Each port has 2 inputs/outputs that can operate in the following 4 modes:

Mode	Pin2	Pin4
00	Digital input	Digital input
01	Digital input/output	Digital input/output
02	Analogue input (4...20 mA)	Digital input/output
04	Analogue input (0...10 V)	Digital input/output

UK

4.6 Voltage supply

4.6.1 US supply voltage

The US supply voltage supplies the device and IO-Link with voltage.



For the AL2x01, US also supplies the outputs and the sensors. There is a common monitoring of the current / switching-off in case of excessive current. Switching off US also switches off the power supply for the outputs and for the sensors and interrupts the IO-Link communication. The AL2x01 device has no additional port to supply the outputs and sensors.

4.6.2 UA voltage supply

UA supplies the outputs of the ports X1.0...X1.7 with voltage.

UA can also serve as sensor supply for the ports as UA_i is connected to UA via a diode. In this case, when UA is switched off, the power supply to the sensors is also switched off. If the sensors are still to be supplied with power despite UA being switched off, UA_i must be connected to a separate power supply.

4.6.3 UA_i sensor supply

The device has 8 sensor supplies. All sensor supplies have a common short-circuit monitoring. If a short circuit is detected, all sensors are switched off. The output voltage of the sensor supplies is proportional to the operating voltage which can vary within the IO-Link specification (18...30 V DC).

4.6.4 Behaviour in case of undervoltage

If the voltage supply of the outputs (UA) falls below 16 V for one port group, all outputs of this port group switch off.

4.6.5 Limit values, protection against excessive current

	AL2x01*	AL2x03*	AL2205*	AL2605*
Total current	1 A	3.6 A	4 A	16 A
Power supply for sensors (pin1)	max. 1 A	400 mA		800 mA
Max. total current per port group	1 A	1.8 A		8 A
Max. current per port	1 A	1.8 A		2 A

For the AL2x01 the total current is limited to 1 A. The current is limited to 1 A per port. If the total current of a port group is too high, the device will switch off the overloaded port group until the current is within the permissible range again.

For the AL2x03 the total current is limited to 3.6 A. The current is limited to 1.8 A per port. If the total current of a port group is too high, the device will switch off the overloaded port group until the current is within the permissible range again.

For the AL2205 the total current is limited to 4 A. The current is limited to 1.8 A per port group. The individual ports have no additional current limitation and can therefore be loaded variably. If the total current of a port group is too high, the device will switch off the overloaded port group until the current is within the permissible range again.

For the AL2605 the total current is limited to 16 A. Each individual port has a current limitation of 2 A. If the current of one port is too high, the device switches off the overloaded port until the current is within the permissible range again.

4.6.6 Derating (AL2605)

For AL2605, the temperature dependence must be taken into account in case of high output current.

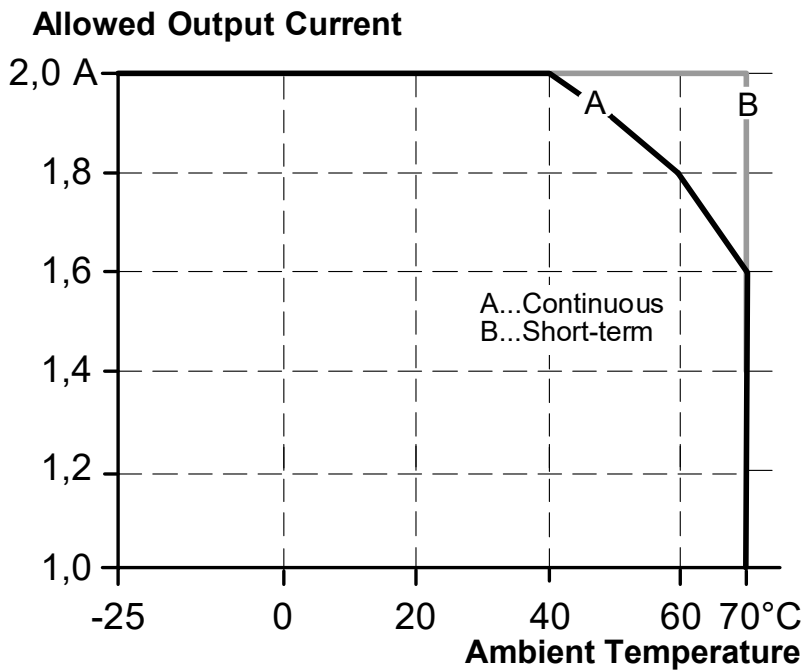

Max. current per port (AL2605)

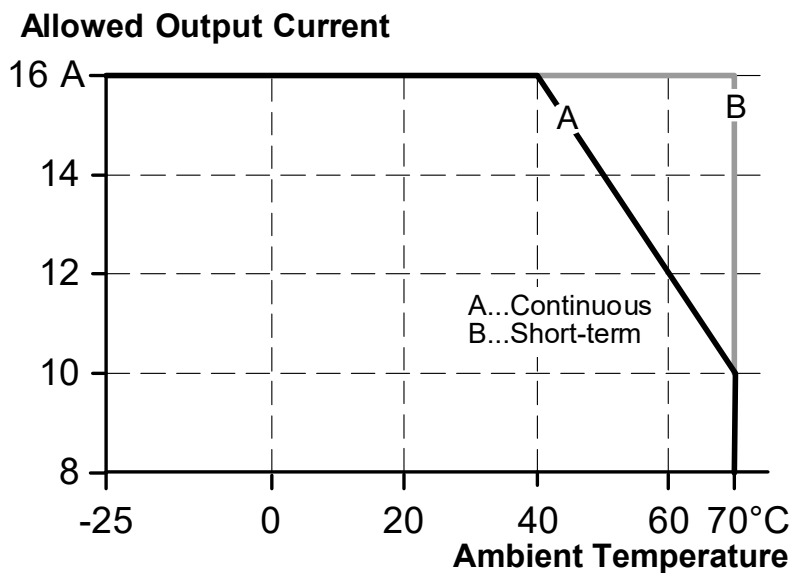

Total current (AL2605)

4.7 Digital input filters

The input signals can be changed via different filters before they are passed on via IO-Link. The following filters are available and are applied to the input signal in this order:

1. Debounce
2. Hold
3. Invert

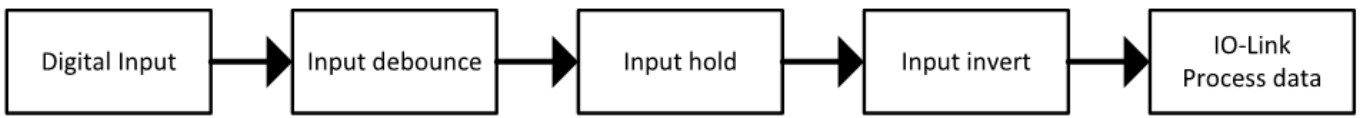

Each of these filters can be configured separately via IO-Link. More information is available in the IODD at www.ifm.com.

The unit detects signals of a length of min. 2 ms. Shorter signals are not detected.



Periodic signals are only detected reliably if the signal period is at least twice as long as the cycle time.

4.7.1 Debounce

The input debouncing filter suppresses noise signals caused by mechanical switches. The filter switches the input signals to the filter output with a delay (debounce time). All signals shorter than the set debounce time are ignored by the filter.

Time diagram debounce filter:

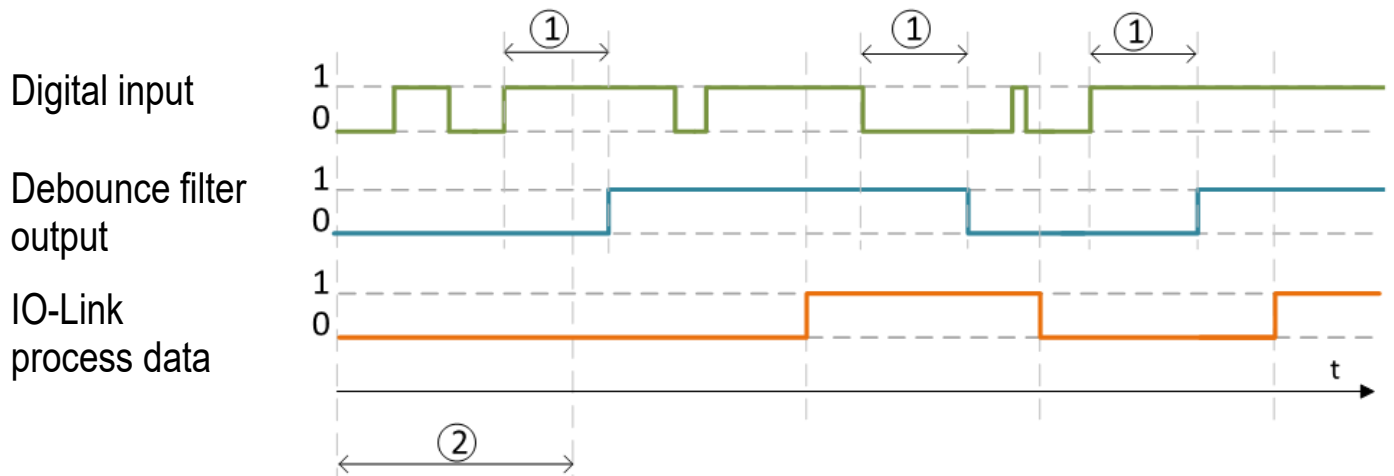

- 1: Hold time
- 2: Cycle time

4.7.2 Hold

This filter prolongs short input pulses. Via the following parameters the filter is configured:

- Hold time: Pulse duration to which short pulses are to be prolonged. Pulses that are present for a longer time than the hold time are not prolonged.
- Hold status: Input level to be prolonged (HIGH or LOW)

Time diagram filter hold with hold status HIGH:

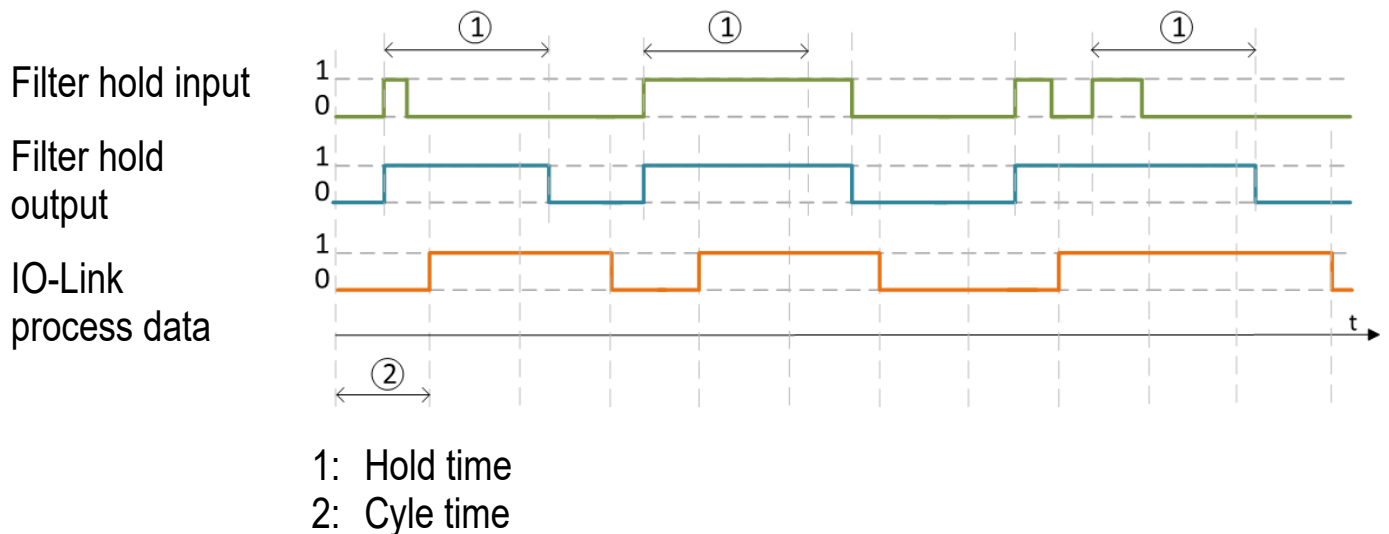

Time diagram filter hold with hold status LOW:

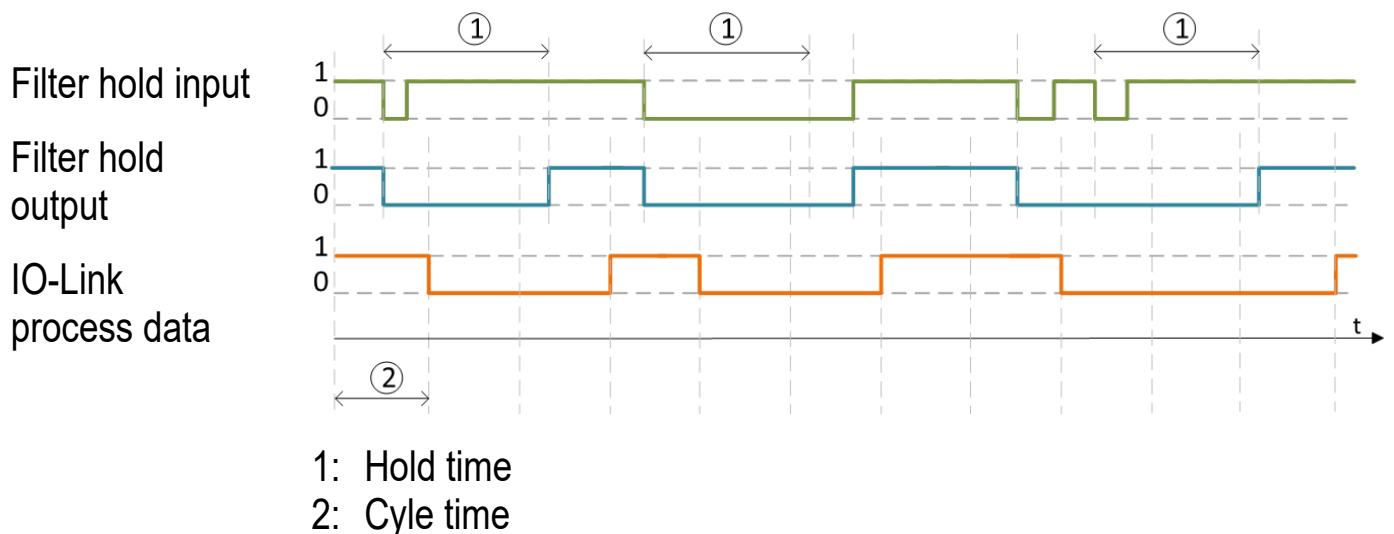

Input signals shorter than the cycle time are not reliably transmitted. To ensure a correct signal transmission via IO-Link the filter hold must be used.

4.7.3 Invert

This filter inverts incoming input signals.

4.7.4 Combination of different input filters

The different input filters can be combined.

In the following example all 3 filters are used:

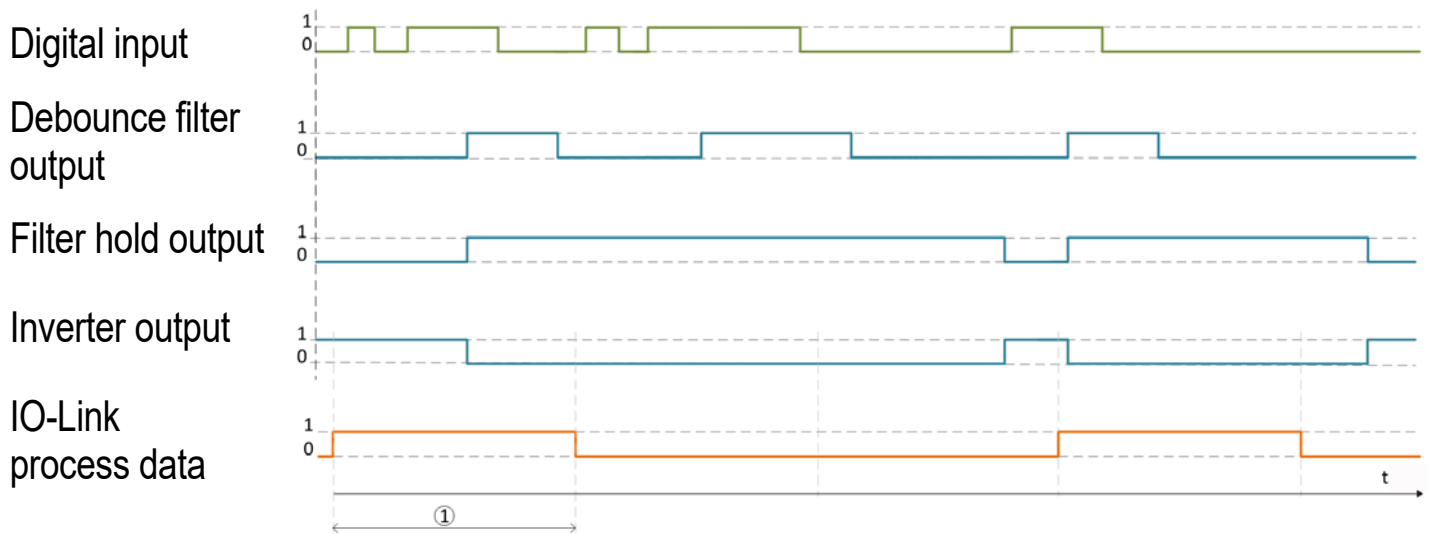

1: Cycle time

4.8 Analogue input signals

If the analogue input is activated, an average value is calculated over the time indicated in the parameter.

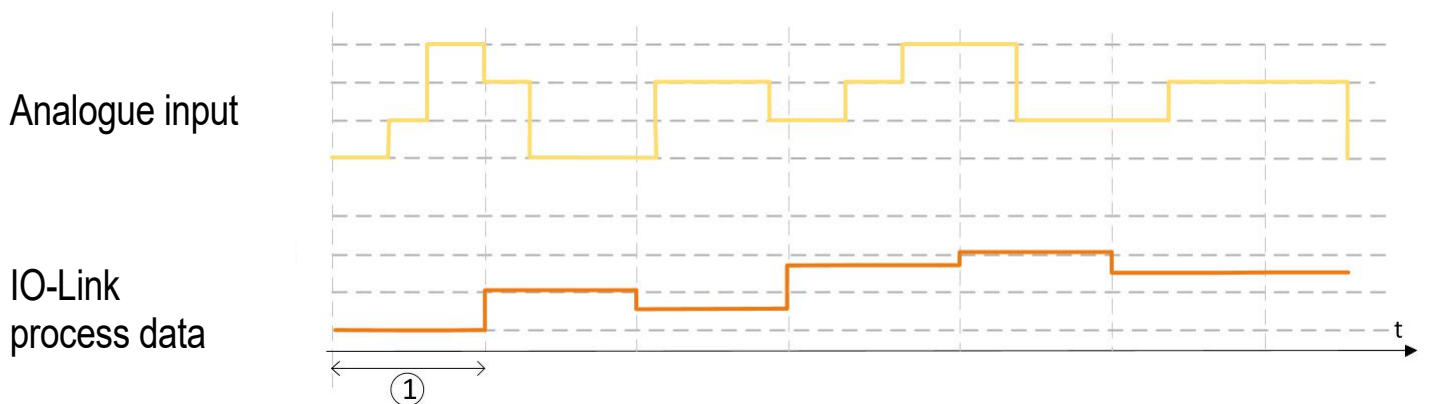

1: Time span for averaging

UK

5 Installation



▶ Disconnect power before installation.



▶ For installation choose a flat mounting surface.

▶ Fasten the module onto the mounting surface using M5 screws and washers.
Tightening torque 1.8 Nm.

▶ Connect the plugs of the sensors to the M12 sockets.
Tightening torque max. 1 Nm.

▶ Cover the unused sockets with protective caps (E12542).
Tightening torque 0.6...0.8 Nm.



▶ Observe the maximum tightening torque of the connection cable.

6 Electrical connection



The unit must be connected by a qualified electrician.

The national and international regulations for the installation of electrical equipment must be adhered to.

Voltage supply according to SELV, PELV

▶ Disconnect power.

▶ Connect the unit.



Do not connect more than 30 m of cable to the outputs.



Maximum cable length for IO-Link communication: 20 m



Do not apply external voltage to the outputs.

6.1 IO-Link connection

The IO-Link port must be connected according to the IO-Link specification. The current required by the units depends on the current load of the sensor supplies.

6.2 Input circuit

The unit has digital type 3 inputs. Connected units must be suitable for these inputs.



Maximum cable length: 20 m

6.3 Pin connection

AL2x01, AL2205, AL2605:

M12 connector, A-coded

IO-Link (X1)

- 1: + 24 V DC (US)
- 2: Not connected
- 3: GND (US)
- 4: IO-Link

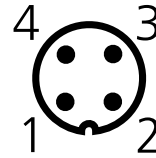

AL2x03:

M12 connector, A-coded

IO-Link (X1)

- 1: + 24 V DC (US)
- 2: + 24 V DC (UA)
- 3: GND (US)
- 4: IO-Link
- 5: GND (UA)

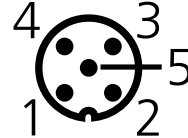

AL2205:

M12 connector, A-coded Voltage supply U_{AUX} (X31)

- 1: + 24 V DC (UAi)
- 2: GND (UA and UAi)
- 3: Not connected
- 4: + 24 V DC (UA)

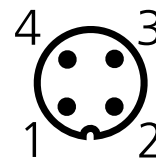

AL2605:

**M12 connector, L-coded
Voltage supply U_{AUX} (X31)**

- 1: + 24 V DC (U_{Ai})
- 2: GND (U_A and U_{Ai})
- 3: Not connected
- 4: + 24 V DC (U_A)
- 5: FE

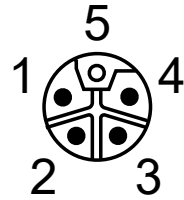

AL2x01, AL2x03, AL2x05:

**M12 connector, A-coded
Ports (X1.0...X1.7)**

- 1: + 24 V DC (U_A and U_{Ai})
- 2: Input/output I/O2
- 3: GND (U_A and U_{Ai})
- 4: Input/output I/O1
- 5: Not connected

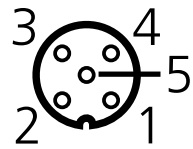

7 Operating and display elements

7.1 AL2x01, AL2x03

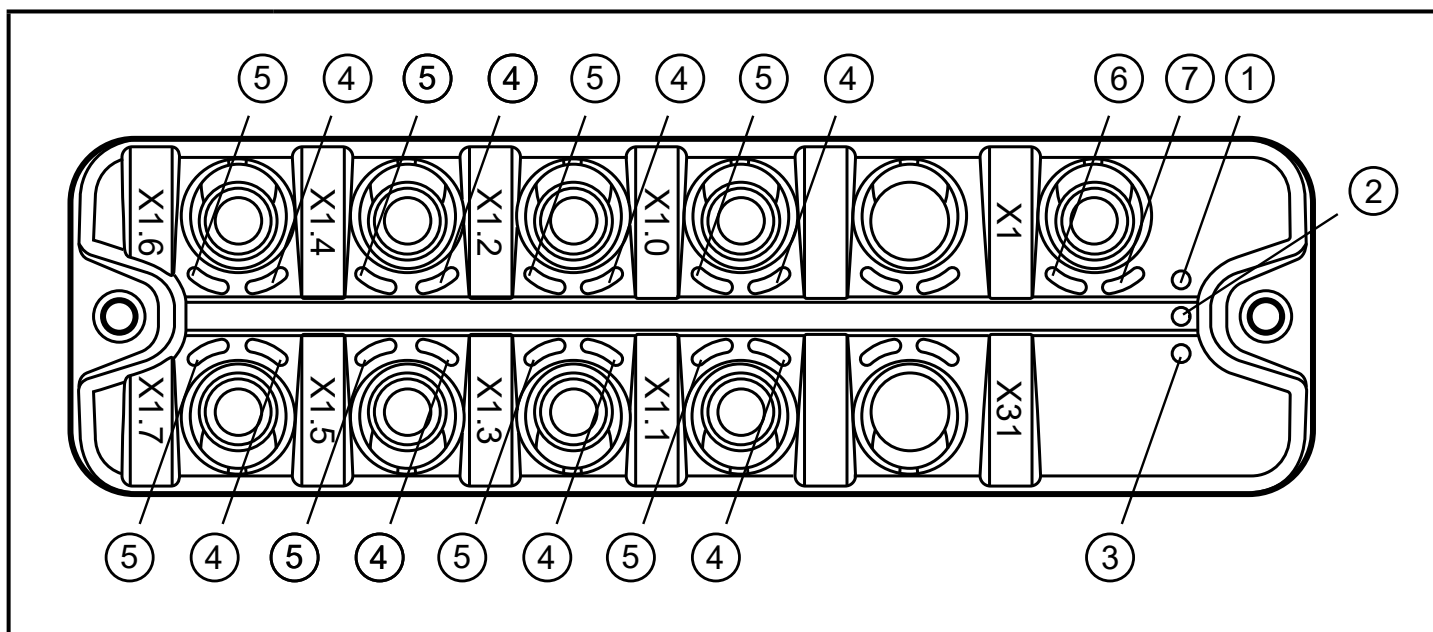

AL2x01, AL2x03

- | | |
|--|--------------------------|
| 1: LED INT | Internal error |
| 2: LED 1 | Error port group 1 |
| 3: LED 2 | Error port group 2 |
| 4: LED I/O2 | Status input/output I/O2 |
| 5: LED I/O1 | Status input/output I/O1 |
| 6: LED  | IO-Link communication |
| 7: LED US | Supply voltage |

UK

7.2 AL2x05

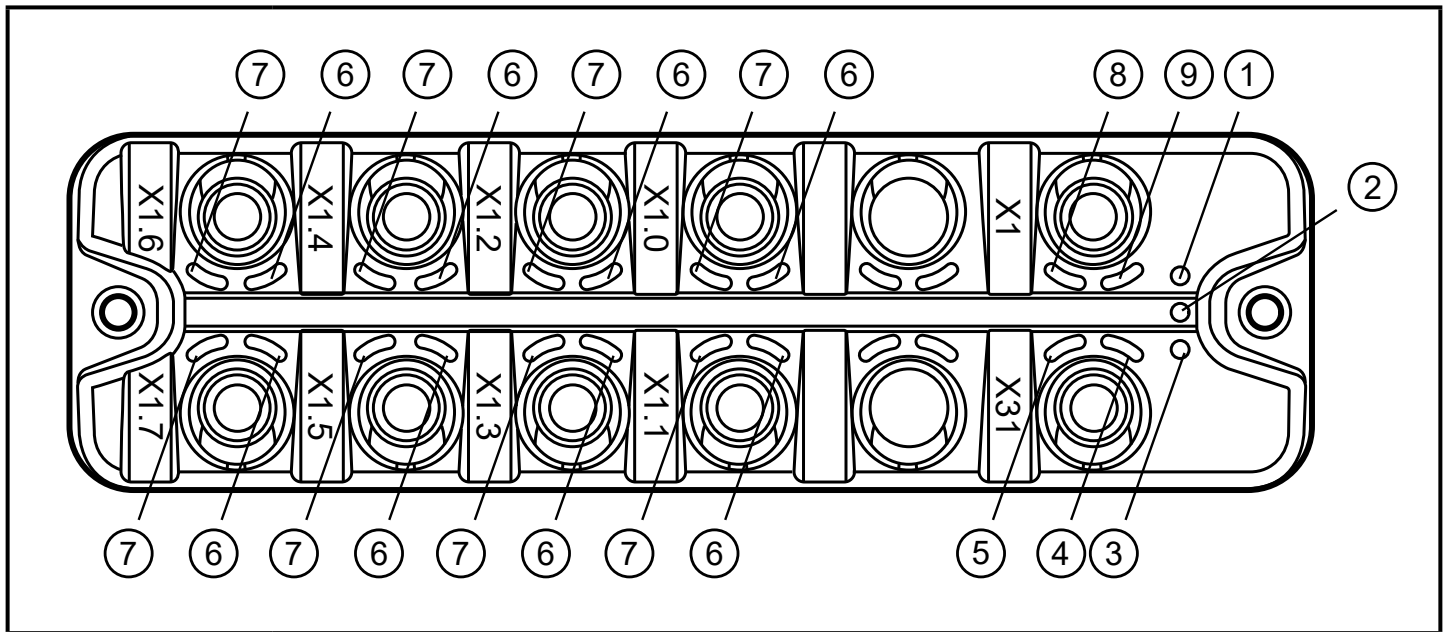

AL2205 / AL2605

- | | |
|--|--------------------------|
| 1: LED INT | Internal error |
| 2: LED 1 | Error port group 1 |
| 3: LED 2 | Error port group 2 |
| 4: LED UA | Supply voltage ports |
| 5: LED UAi | Supply voltage sensors |
| 6: LED I/O2 | Status input/output I/O2 |
| 7: LED I/O1 | Status input/output I/O1 |
| 8: LED  | IO-Link communication |
| 9: LED US | Supply voltage |

7.3 LEDs

LED	Colour	Mode	Status	Description
INT	red		on	internal error
			off	no internal error unit in the operating mode
1	red		on	short circuit in port group 1
			off	no error in port group 1 unit in the operating mode
2	red		on	short circuit in port group 2
			off	no error in port group 2 unit in the operating mode
US	green		on	voltage supply ≥ 18 V
			off	voltage supply < 16 V
UA	green		on	voltage supply ≥ 18 V
			off	voltage supply < 16 V
UAi	green		on	voltage supply ≥ 18 V
			off	voltage supply < 16 V
	green		on	IO-Link communication active
			off	IO-Link communication not active
I/O1, I/O2	yellow	DI	on	input signal high
			off	input signal low
			flashing	short circuit
		DO	on	input signal high
			off	input signal low
			flashing	short circuit
		AI	on	signal within the measuring range
			off	signal outside the measuring range
			flashing	short circuit

UK

8 Scale drawing

8.1 AL2x01, AL2x03

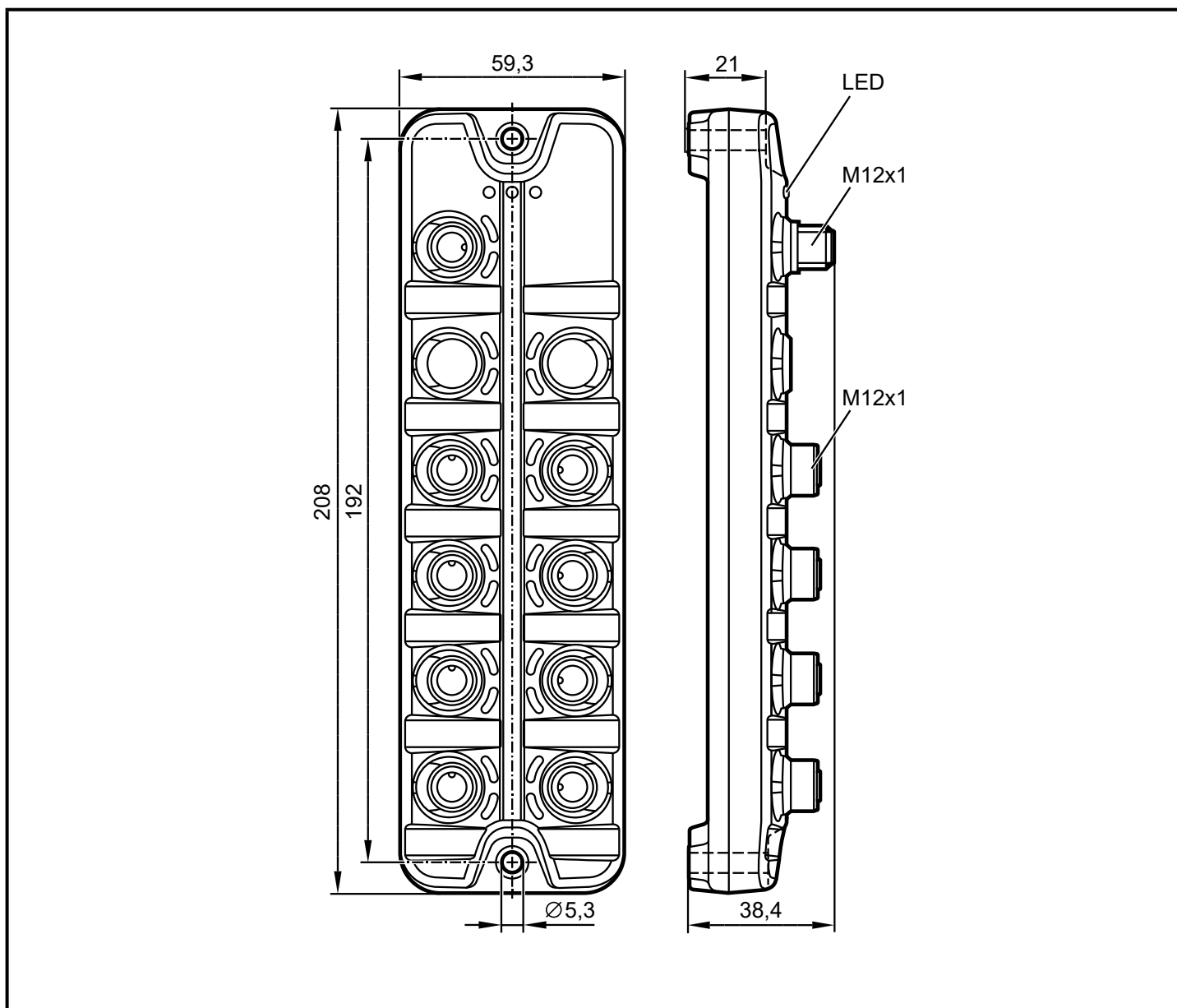

Dimensions [mm]

8.2 AL22x5

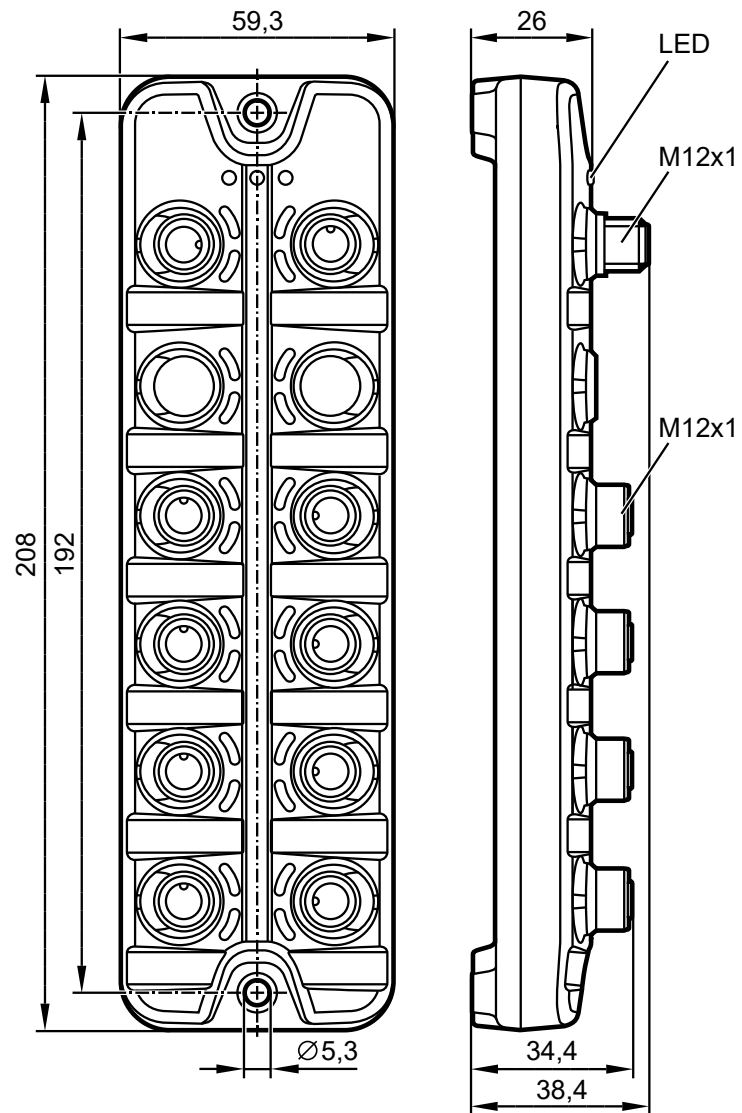

Dimensions [mm]

8.3 AL26x5

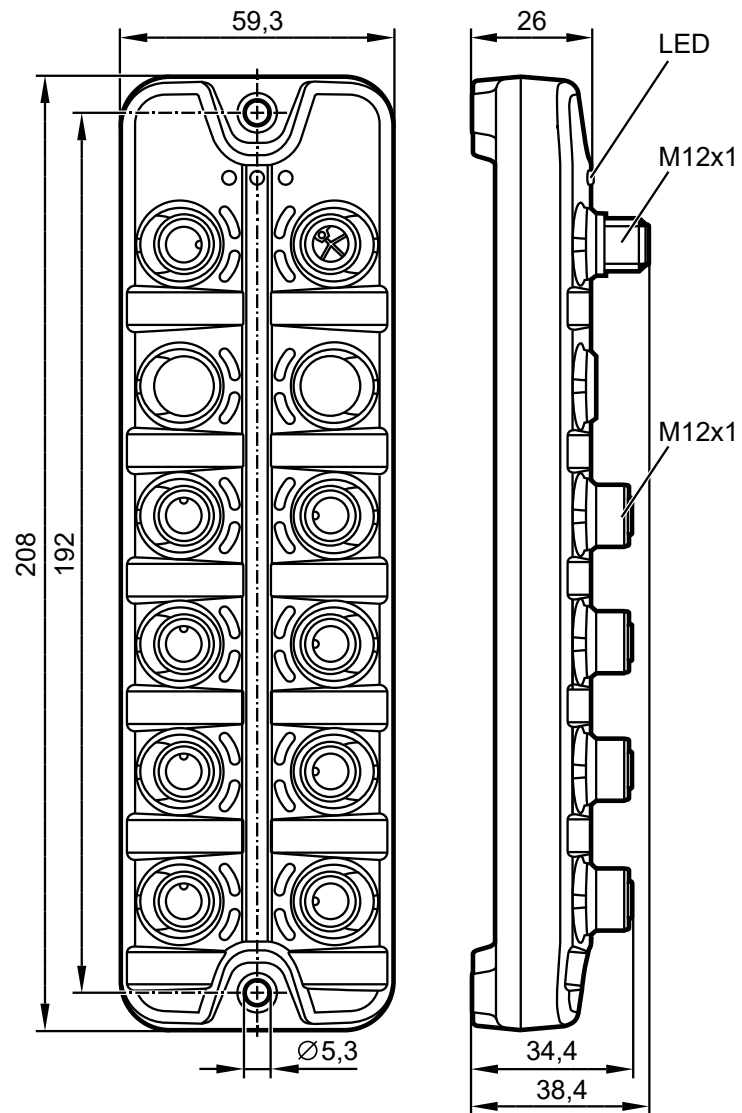

Dimensions [mm]

9 Technical data

Technical data and further information at www.ifm.com

10 Maintenance, repair and disposal

The operation of the unit is maintenance-free.

Dispose of the unit in an environmentally friendly way in accordance with the applicable national regulations when it is no longer used.

10.1 Cleaning the housing surface

- ▶ Disconnect the device.
- ▶ Clean the device from dirt using a soft, chemically untreated and dry cloth.
- ▶ In case of severe soiling, use a damp cloth.



Micro-fibre cloths without chemical additives are recommended.

11 Approvals/standards

EU declarations of conformity, approvals etc. can be downloaded at: www.ifm.com