

SEMG412 – SEMG442

Type 4 Safety Light Curtain

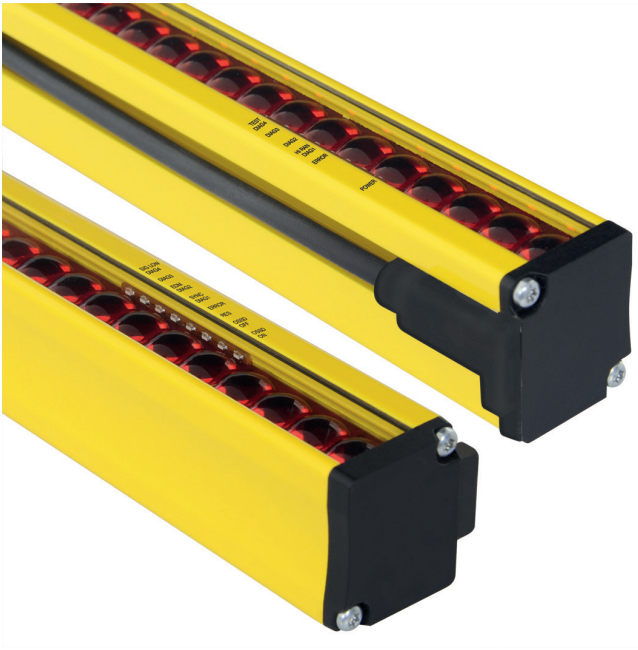

Operating Instructions

Translation of the Original Operating Instruction
Subject to change without notice
Available as PDF version only
Status: 11.07.2019
Version: 08
www.wenglor.com

Table of Contents

1. General	5
1.1 Information Concerning these Instructions	5
1.2 Explanations of Symbols	5
1.3 List of Abbreviations	6
1.4 Limitation of Liability	6
1.5 Copyrights	6
2. For Your Safety	7
2.1 Use for Intended Purpose	7
2.2 Use for Other than the Intended Purpose	7
2.3 Personnel Qualifications	8
2.4 Modification of Products	8
2.5 General Safety Precautions	8
2.6 Approvals and protection class	8
3. Technical Data	9
3.1 Response Times	11
3.2 Dimensional Drawings Safety Light Curtain	12
3.3 Housing dimensions, mounting technology	14
3.4 Connection Diagrams	15
3.5 Complementary Products (see catalog)	16
3.6 Layout	17
3.7 Control Panel	18
3.8 Scope of Delivery	18
4. Transport and Storage	19
4.1 Transport	19
4.2 Storage	19
5. Installation and Electrical Connection	20
5.1 System Overview	20
5.2 Installation	22
5.2.1 Installation with ZEMX001 Mounting Bracket	22
5.2.2 Installation with ZEMX002 Mounting Bracket	22
5.2.3 Installation with ZEMZ001 Mounting System	23
5.3 Securing the Danger Zone	24

5.4	Safety Clearance	25
5.4.1	Safety Clearance for Vertical Approach to the Safety Field	25
5.4.2	Safety Clearance for horizontal approach to the Safety Field	28
5.4.3	Safety Clearance for Angular Approach to the Safety Field	28
5.5	Clearance from Reflective Surfaces	29
5.6	Multiple Systems	30
5.7	Deflection Mirror	31
5.8	Electrical Connection	32
5.9	Optical Alignment	32
5.10	Diagnostics	33
6.	Functions	34
6.1	Default Settings	34
6.2	Function definition	34
7.	Settings	37
7.1	Initial Start-Up	37
7.2	Overview of All Functions	43
7.3	Adjusting Range	44
7.3.1	Low Range	44
7.3.2	High Range	45
7.4	Safety Mode Without Contactor Monitoring	46
7.5	Safety Mode With Contactor Monitoring	47
7.6	Start-Up and Restart Inhibit Without Contactor Monitoring	49
7.7	Start-Up and Restart Inhibit With Contactor Monitoring	51
7.8	Signal output	53
7.9	Test Function	55
7.10	Restoring Default Settings	56
8.	Testing	58
8.1	Testing Prior to Initial Start-Up	58
8.2	Annual Inspection	59
8.3	Daily Inspection	59
9.	Maintenance	61
10.	Shutdown	61

11. Proper Disposal	61
12. Appendix	61
12.1 Change Index, Operating Instructions	61
12.2 Overview of Receiver Parameters Configuration	62
12.3 Display during Normal Operation	62
12.3.1 Receiver	62
12.3.2 Emitter	64
12.4 Display in Case of Error	65
12.4.1 Receiver	65
12.4.2 Emitter	67
12.5 Initial Start-Up Checklist	68
12.6 Connection Examples	70
12.6.1 Restart Inhibit Without Contactor Monitoring at SEMG4xxx	70
12.6.2 Restart Inhibit and Contactor Monitoring at SEMG4xxx	71
12.6.3 Restart Inhibit Without Contactor Monitoring at Safety Relay	72
12.6.4 SEMG4xx With Safety Mode Without Contactor Monitoring	73
12.7 EU Declaration of Conformity	74

1. General

1.1 Information Concerning these Instructions

- These instructions are valid for the following products: SEMG4xx: Safety Light Curtain sales set consisting of emitter and receiver, SEMG5xx: Safety Light Curtain emitter, SEMG6xx: Safety Light Curtain receiver.
- They make it possible to use the product safely and efficiently.
- These instructions are an integral part of the product and must be kept on hand for the entire duration of its service life.
- Local accident prevention regulations and national work safety regulations must be complied with as well.

**NOTE:**

The operating instructions must be read carefully before using the product and must be kept on hand for later reference.

1.2 Explanations of Symbols

- Safety precautions and warnings are emphasized by means of symbols and attention-getting words.
- Safe use of the product is only possible if these safety precautions and warnings are adhered to.

The safety precautions and warnings are laid out in accordance with the following principle:

**ATTENTION-GETTING WORD!****Type and Source of Danger!**

Possible consequences in the event that the hazard is disregarded.

- Measures for averting the hazard.

The meanings of the attention-getting words, as well as the scope of the associated hazards, are listed below:

**DANGER!**

This word indicates a hazard with a high degree of risk which, if not avoided, results in death or severe injury.

**WARNING!**

This word indicates a hazard with a medium degree of risk which, if not avoided, may result in death or severe injury.

**CAUTION!**

This word indicates a hazard with a low degree of risk which, if not avoided, may result in minor or moderate injury.

**ATTENTION:**

This word draws attention to a potentially hazardous situation which, if not avoided, may result in property damage.

**NOTE!**

A note draws attention to useful tips and suggestions, as well as information regarding efficient, error-free use.

LED Symbols

Descriptions of statuses of diagnostics LEDs



LED is lit up continuously.



The LED can have any status (lit up or off).



LED blinks.



LED is off.

1.3 List of Abbreviations

Abbreviation	Meaning
ESPE	Electro-sensitive protective equipment
SFH	Safety field height
EDM	External device monitoring = contactor monitoring
RES	Restart inhibit
OSSD	Output signal switching device

1.4 Limitation of Liability

- The product has been developed in consideration of the current state-of-the-art and applicable standards and guidelines. Subject to change without notice.
- wenglor excludes all liability in the event of:
 - Non-compliance with the instructions
 - Use of the product for purposes other than those intended
 - Use by untrained personnel
 - Use of unapproved replacement parts
 - Unapproved modification of products
 - These operating instructions do not imply any guarantee from wenglor with regard to the described procedures or specific product characteristics.
 - wenglor assumes no liability for printing errors or other inaccuracies contained in these operating instructions, unless wenglor was verifiably aware of such errors at the point in time at which the operating instructions were prepared.

1.5 Copyrights

- The contents of these instructions are protected by copyright law.
- All rights are reserved by wenglor.
- Commercial reproduction or any other commercial use of the provided content and information, in particular graphics and images, is not permitted without previous written consent from wenglor.

2. For Your Safety

2.1 Use for Intended Purpose

The product is based on the following functional principle:

Safety Light Curtain

The Safety Light Curtain monitors the safety field between the emitter and the receiver. If the safety field is interrupted by an obstruction, a switching command is triggered. This switching command either prevents initialization of a hazardous machine motion, or stops an action which has already been started.

Use of the Light Curtain is only permissible if:

- Hazardous motion can be stopped by electrical means using the light curtain's safety output
- Adequate detection of possible obstruction is assured with existing resolution
- Use of a type 4 Light Curtain with performance level PL e is permissible

This product can be used in the following industry sectors:

- Special machinery manufacturing
- Heavy machinery manufacturing
- Logistics
- Automotive industry
- Food industry
- Packaging industry
- Pharmaceuticals industry
- Clothing industry
- Plastics industry
- Woodworking industry
- Consumer goods industry
- Paper industry
- Electronics industry
- Glass industry
- Steel industry
- Printing industry
- Aviation industry
- Construction industry
- Chemicals industry
- Agriculture industry
- Alternative energy
- Raw materials extraction
- Other

2.2 Use for Other than the Intended Purpose

- The product is not suitable for use in potentially explosive atmospheres.
- Only accessories supplied or approved by wenglor may be used with the product.



DANGER!

Risk of personal injury or property damage in case of use for other than the intended purpose!

Use for other than the intended purpose may lead to hazardous situations.

- Observe instructions regarding use for intended purpose.

2.3 Personnel Qualifications

- Suitable technical training is a prerequisite.
- In-house electronics training is required.
- Technical knowledge and experience concerning use of the guard is required in order to assure correct evaluation of the safe working status during assembly, initial start-up and electrical installation.
- Trained personnel must have uninterrupted access to the operating instructions.



CAUTION!

Risk of personal injury or property damage in case of incorrect initial start-up and maintenance!

Personal injury and damage to equipment may occur.

- Adequate training and qualification of personnel

2.4 Modification of Products



NOTE!

Modification of the product is impermissible.

Non-observance may result in loss of the CE marking and the guarantee may be rendered null and void.

2.5 General Safety Precautions



NOTE!

- These instructions are an integral part of the product and must be kept on hand for the entire duration of its service life.
- Read the operating instructions carefully before using the product.
- Protect the sensor against contamination and mechanical influences.
- Additional measures may be necessary in order to assure that the ESPE does not fail in a dangerous fashion due to other types of light which are used in a special application (e.g. emission due to welding sparks or the effects of stroboscope lights).

2.6 Approvals and protection class

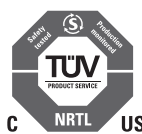

3. Technical Data

Order No.	Emitter: SEMG531–SEMG542 Receiver: SEMG631–SEMG642	Emitter: SEMG512–SEMG522 Receiver: SEMG612–SEMG622
Optical Data		
Range	0.2...6 m	0.25...14 m
Safety field height	250...1811 mm	326...1827 mm
Resolution	14 mm	30 mm
Aperture angle	± 2.5°	
Emitter wavelength	Typically 630 nm	
Coated optics	Yes	
Resistance to extraneous light	10,000 lux	
Electrical Data		
Supply power	19.2 to 28.8 V DC (SELV, PELV power pack), it must be possible to bridge power failures of 20 ms or more (EN 60204-1) <u>For US and Canada:</u> Device to be supplied by a certified Class 2 power supply that complies with the requirements according NEC and CEC.	
Protection class	III (SELV/PELV)	
Fusing of supply voltage, inputs	Max. 2 A	
Power consumption, receiver (operating voltage = 24 V)	≤ 200 mA (without load)	
Power consumption, emitter (operating voltage = 24 V)	≤ 100 mA	
Internal fuse	2 A	
Temperature range	SFH ≤ 1061 mm: –25...55° C SFH > 1061 mm: –5...55° C	–25...55° C
Storage temperature	–25...60° C	
Relative humidity	≤ 95% (non-condensing)	
Vibration resistance	5 g (10 ... 55 Hz)	
Shock resistance	10 g/16 ms	
Signal output		
Signal output	Semiconductor, PNP	
Number of signal outputs	1	
Signal output switching current	≤ 100 mA	
Signal output voltage drop	≤ 2.5 V	
Safety outputs		
Safety outputs	Semiconductor, PNP	
Number of safety outputs	2	
Safety output switching current	≤ 300 mA	
Safety output leakage current	≤ 2 mA	
Voltage drop at safety output	≤ 2.3 V	
Max. voltage in off state	< 2 V	
Max. capacitive load	≤ 1 μF	

Order No.	Emitter: SEMG531–SEMG542 Receiver: SEMG631–SEMG642	Emitter: SEMG512–SEMG522 Receiver: SEMG612–SEMG622
Max. Inductive load	≤ 2.2 mH	
Test pulse width, rate	< 300 μs, typically 20 ms	
Restart time after reach-in	Typically 2 × response time	
Inputs		
Voltage range	–30...30 V DC	
Switching thresholds	LOW: < 5 V, < 2 mA HI: > 11 V, 6...30 mA	
Activation duration	0.1...4 s	
Acknowledgment input		
EDM response/drop-off time	350 ms	
Short-circuit proof	Yes	
Reversed polarity and overload proof	Yes	
Max. cable length	< 35 m/0.25 sq. mm < 50 m/0.34 sq. mm < 72 m/0.50 sq. mm	
Mechanical		
Housing material	Aluminum	
Protection	IP65, IP67	
Emitter connection	300 mm cable, 4/5-pin M12	
Emitter cable diameter	5 mm	
Receiver connection	300 mm cable, 8-pin M12	
Receiver cable diameter	6 mm	
Min. bending radius	5 × cable diameter (permanently laid) 10 × cable diameter (dynamic installation)	
Technical Safety Data		
ESPE type (EN 61496)	4	
Performance level (EN ISO 13849-1:2008)	Cat. 4 PL e	
Safety integrity level (EN 62061)	SIL cl 3	
PFHd	1,6 E-8 1/h	
Service life TM (EN ISO 13849-1:2008)	20 a	
Functions		
Finger protection	Yes	No
Hand protection	No	Yes
Safety mode (Automatic Operation)	Yes	
Restart inhibit	Yes	
Contactors monitoring	Yes	

The following table specifies the tightening torques of the plugs and mounting options in order to assure compliant, error-free operation:

Connection type	Connection tightening torque in Nm
M12	0,4

3.1 Response Times

Resolution: 14 mm

Order Number	Response Time [ms]
SEMG631	7,6
SEMG632	8,3
SEMG633	9,9
SEMG634	11,6
SEMG635	13,2
SEMG636	14,9
SEMG637	16,5
SEMG638	18,2
SEMG639	19,8
SEMG640	21,5
SEMG641	23,1
SEMG642	24,8

Resolution: 30 mm

Order Number	Response Time [ms]
SEMG612	6,6
SEMG613	7,5
SEMG614	8,3
SEMG615	9,1
SEMG616	9,9
SEMG617	10,8
SEMG618	11,6
SEMG619	12,4
SEMG620	13,2
SEMG621	14,1
SEMG622	14,9

3.2 Dimensional Drawings Safety Light Curtain

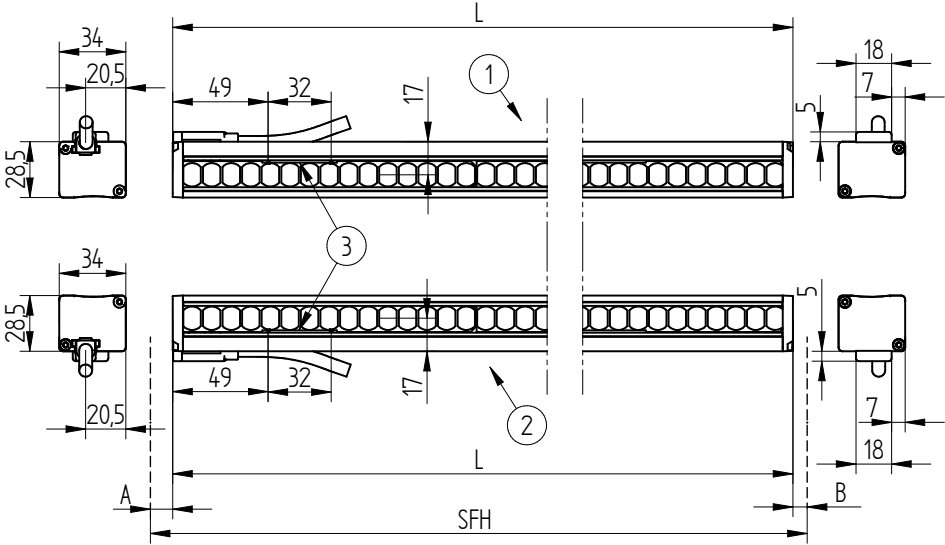

1 = emitter, 2 = receiver, 3 = control panel, SFH = safety field height

Emitter Detail

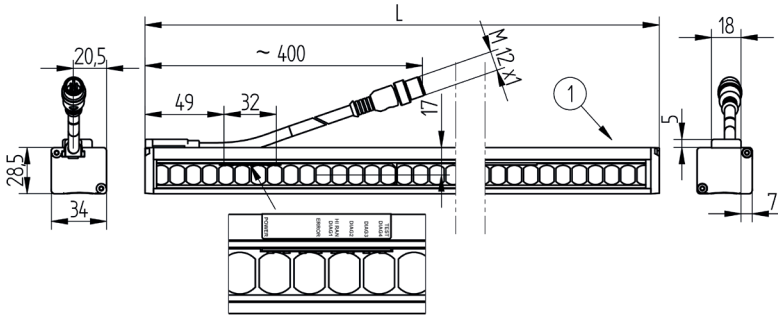

Receiver Detail

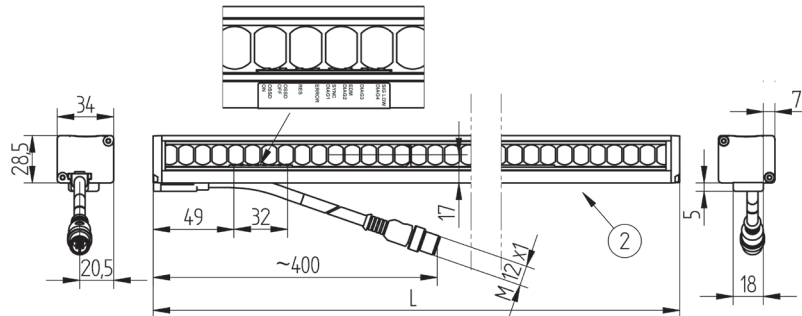

Resolution: 14 mm

Order Number	SFH (mm)	L (mm)	A (mm)	B (mm)	Max. weight per sensor (kg)
SEMGx31	250	249	1	0	0,38
SEMGx32	310	309	1	0	0,53
SEMGx33	460	459	1	0	0,69
SEMGx34	610	609	1	0	0,84
SEMGx35	761	760	1	0	0,99
SEMGx36	911	910	1	0	1,15
SEMGx37	1061	1060	1	0	1,30
SEMGx38	1211	1210	1	0	1,45
SEMGx39	1361	1360	1	0	1,61
SEMGx40	1511	1510	1	0	1,76
SEMGx41	1661	1660	1	0	1,91
SEMGx42	1811	1810	1	0	2,07

Resolution: 30 mm

Order Number	SFH (mm)	L (mm)	A (mm)	B (mm)	Max. weight per sensor (kg)
SEMGx12	326	311	15	0	0,53
SEMGx13	486	461	15	10	0,69
SEMGx14	626	611	15	0	0,84
SEMGx15	787	762	15	10	0,99
SEMGx16	927	912	15	0	1,15
SEMGx17	1087	1062	15	10	1,30
SEMGx18	1227	1212	15	0	1,45
SEMGx19	1387	1362	15	10	1,61
SEMGx20	1527	1512	15	0	1,76
SEMGx21	1687	1662	15	10	1,91
SEMGx22	1827	1812	15	0	2,07

3.3 Housing dimensions, mounting technology

ZEMX001 Mounting Bracket

- For wall/profile mounting
- Scope of delivery: 2 pieces
- Including screws, washers and slot nuts

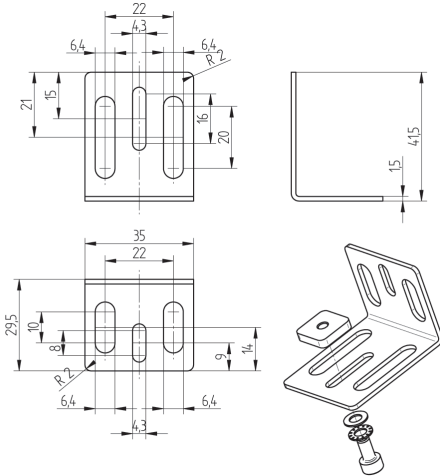

ZEMX002 Mounting Bracket

- For mounting in Protection Columns
- Scope of delivery: 2 pieces
- Including screws, washers and slot nuts

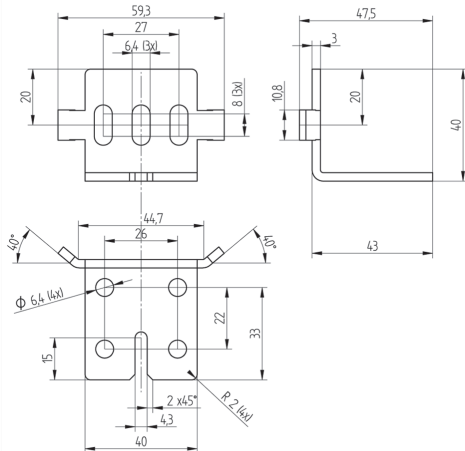

ZEMZ001 Mounting System

- For wall mounting
- Adjustable
- Scope of delivery: 2 pieces
- Including screws, washers and slot nuts

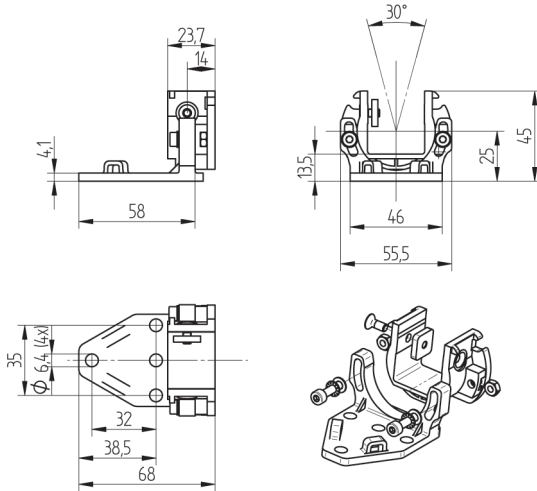

3.4 Connection Diagrams

Receiver

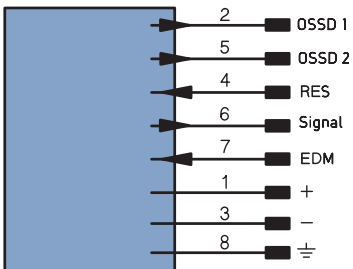

Emitter

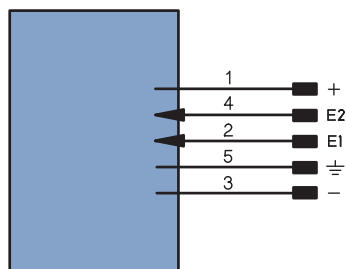

- | | |
|--------|-------------------------|
| + | + supply power |
| - | 0 V supply power |
| OSSD | Safety output |
| Signal | Signal output |
| ⊕ | Ground |
| RES | Acknowledgement input |
| EDM | Contacting monitoring |
| E | Analog or digital input |

Legend

+	Supply Voltage +
-	Supply Voltage 0 V
~	Supply Voltage (AC Voltage)
A	Switching Output (NO)
Ā	Switching Output (NC)
V	Contamination/Error Output (NO)
∇	Contamination/Error Output (NC)
E	Input (analog or digital)
T	Teach Input
Z	Time Delay (activation)
S	Shielding
RxD	Interface Receive Path
TxD	Interface Send Path
RDY	Ready
GND	Ground
CL	Clock
E/A	Output/Input programmable
	IO-Link
PoE	Power over Ethernet
IN	Safety Input
SSD	Safety Output
Signal	Signal Output
BL_D +/-	Ethernet Gigabit bidirect. data line (A-D)
EN _{RS422}	Encoder 0-pulse 0-0̄ (TTL)

PT	Platinum measuring resistor
nc	not connected
U	Test Input
Ū	Test Input inverted
W	Trigger Input
W-	Ground for the Trigger Input
O	Analog Output
O-	Ground for the Analog Output
BZ	Block Discharge
AMV	Valve Output
a	Valve Control Output +
b	Valve Control Output 0 V
SY	Synchronization
SY-	Ground for the Synchronization
E+	Receiver-Line
S+	Emitter-Line
±	Grounding
SrR	Switching Distance Reduction
Rx +/-	Ethernet Receive Path
Tx +/-	Ethernet Send Path
B _{us}	Interfaces-Bus A(+)/B(-)
La	Emitted Light disengageable
Mag	Magnet activation
RES	Input confirmation
EDM	Contactors Monitoring

EN _{RS422}	Encoder A/Ā (TTL)
EN _{RS422}	Encoder B/B̄ (TTL)
ENa	Encoder A
ENb	Encoder B
AMIN	Digital output MIN
AMAX	Digital output MAX
AOK	Digital output OK
SY In	Synchronization In
SY OUT	Synchronization OUT
OLt	Brightness output
M	Maintenance
rsv	reserved
Wire Colors according to IEC 60757	
BK	Black
BN	Brown
RD	Red
OG	Orange
YE	Yellow
GN	Green
BU	Blue
VT	Violet
GY	Grey
WH	White
PK	Pink
GNYE	Green/Yellow

3.5 Complementary Products (see catalog)

wenglor offers Connection Technology for field wiring.

Suitable Mounting Technology No. **810** **790** **820**

Suitable Connection Technology No. (emitter, Color code for connection cable)

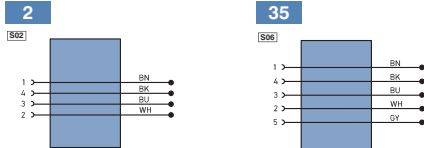

Suitable Connection Technology No. (receiver, Color code for connection cable)

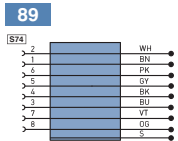

Protection Column with Screening Grid SZ000EGxxxNN01

Protection Column with Deflection Mirror SZ000EUxxxNN01

Safety Relay SG4-00VA000R2, SR4B3B01S, SR4D3B01S

Deflection Mirror Z2UG00x

3.6 Layout

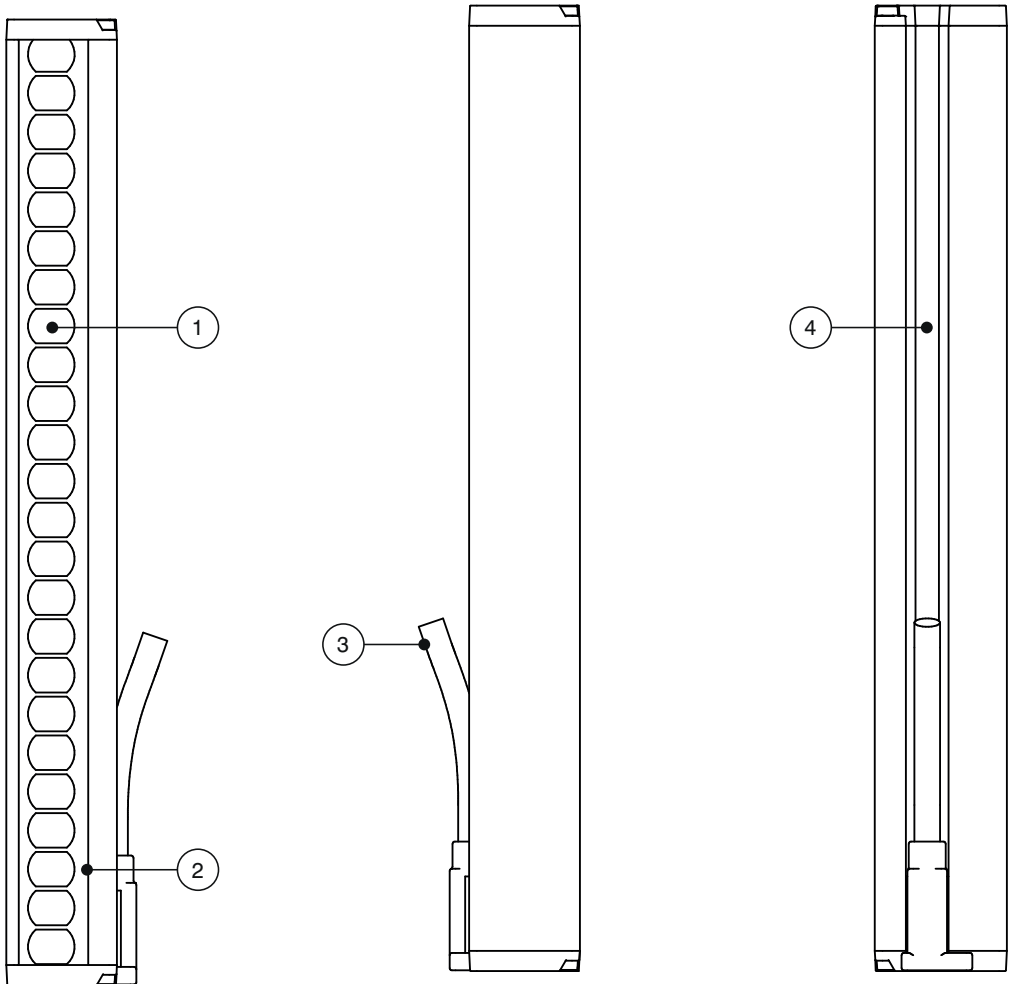

- 1 = optics (safety field)
- 2 = indicator LEDs (control panel)
- 3 = plug connector with cable
- 4 = mounting slot

3.7 Control Panel

Receiver

	Display	Color	
8	Diagnostics 4/weak signal	YE	
7	Diagnostics 3	YE	
6	Diagnostics 2/contactor monitoring	YE	
5	Diagnostics 1/synchronization	YE	
4	Error	RD	
3	Acknowledgment prompt	YE	
2	OSSD off	RD	
1	OSSD on	GN	

Emitter

	Display	Color	
6	Diagnostics 4/test	YE	
5	Diagnostics 3	YE	
4	Diagnostics 2	YE	
3	Diagnose 1/high range	YE	
2	Error	RD	
1	Supply power	GN	

3.8 Scope of Delivery

- Emitter and receiver with identical SFH
- Quick start
- Operating Instructions on CD
- Test rod matched to the resolution of the ESPE (Ø 14 mm – ZEMG003/Ø 30 mm – ZEMG004)
- Daily Inspection sticker
- Mounting bracket (ZEMX001)

4. Transport and Storage

4.1 Transport

Upon receipt of shipment, inspect the goods for damage in transit. In the case of damage, conditionally accept the package and notify the manufacturer of the damage. Then return the device making reference to damage in transit.

4.2 Storage

The following points must be taken into condition with regard to storage:

- Do not store the product outdoors.
- Store the product in a dry, dust-free place.
- Protect the product against mechanical impacts.
- Protect the product against exposure to direct sunlight.



ATTENTION:

Risk of property damage in case of improper storage!

The product may be damaged.

- Comply with storage instructions.
-

5. Installation and Electrical Connection

5.1 System Overview

Connector Cables	
M12, 4-pin to open end (for emitter)	
S23-2M (straight, PVC)	2 m
S23-5M (straight, PVC)	5 m
S23-10M (straight, PVC)	10 m
S29-2M (angled, PVC)	2 m
S29-5M (angled, PVC)	5 m
S29-10M (angled, PVC)	10 m
M12, 5-pin to open end (for emitter)	
ZAS35R501 (straight, PUR)	5 m
M12, 8-pin to open end (for receiver)	
ZAS89R501 (straight, PUR)	5 m
ZAS89R601 (straight, PUR)	10 m
ZAS89R502 (angled, PUR)	5 m
ZAS89R602 (angled, PUR)	10 m
Safety Relays	
SG4-00VA000R2	
SR4B3B01S	
SR4D3B01S	

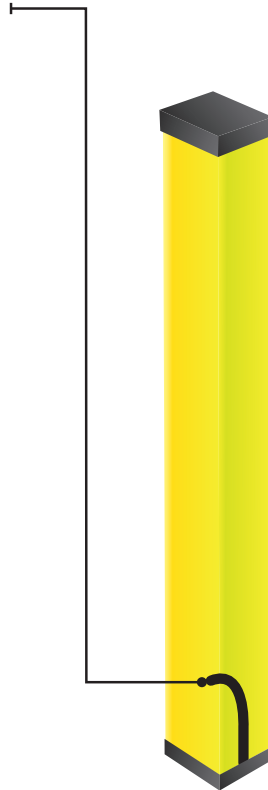

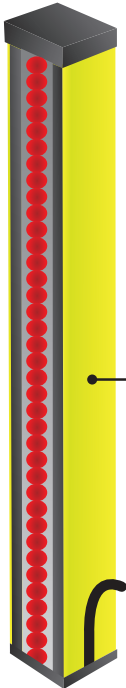

Mounting Technology

Mounting bracket ZEMX001

Mounting bracket ZEMX002

Mounting system ZEMZ001

Safety Columns

SZ000EG125NN01 (with protective disc)	930 mm
---------------------------------------	--------

SZ000EG170NN01 (with protective disc)	1380 mm
---------------------------------------	---------

000EG215NN01 (with protective disc)	1830 mm
-------------------------------------	---------

SZ000EU125NN01 (with path-folding mirror)	930 mm
---	--------

SZ000EU170NN01 (with path-folding mirror)	1380 mm
---	---------

SZ000EU215NN01 (with path-folding mirror)	1830 mm
---	---------

Path-Folding Mirrors

Z2UG001	80 mm
---------	-------

Z2UG002	750 mm
---------	--------

Z2UG003	1350 mm
---------	---------

Z2UG004	1900 mm
---------	---------

5.2 Installation

- Protect the product from contamination during installation.
- Observe all applicable electrical and mechanical regulations, standards, and safety rules.
- Protect the product against mechanical influences.
- Make sure that the sensor is mounted in a mechanically secure fashion.
- Specified torque values must be complied with (see section “3. Technical Data” on page 9).



ATTENTION:

Risk of property damage in case of improper installation!

The product may be damaged.

- Comply with installation instructions.

5.2.1 Installation with ZEMX001 Mounting Bracket

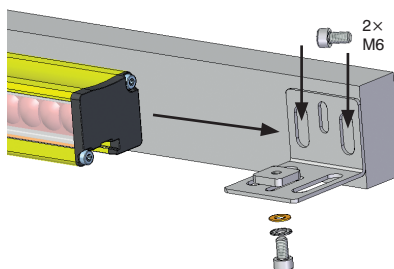
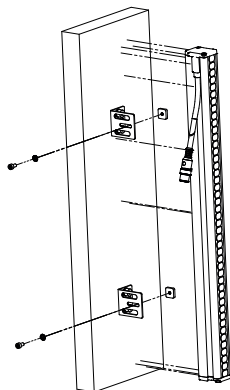

5.2.2 Installation with ZEMX002 Mounting Bracket

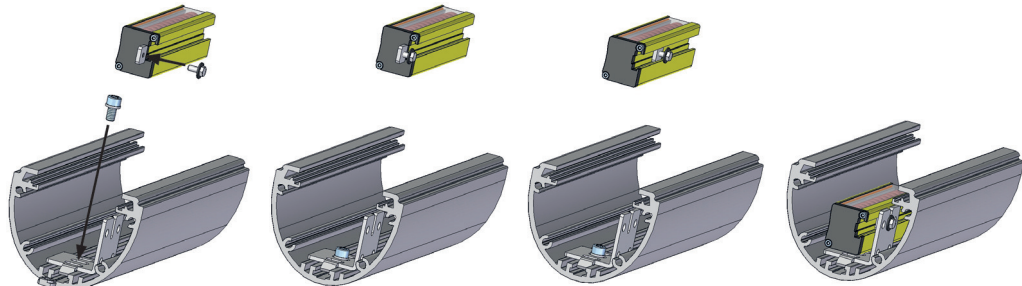

5.2.3 Installation with ZEMZ001 Mounting System

1. Install the wall mounting.

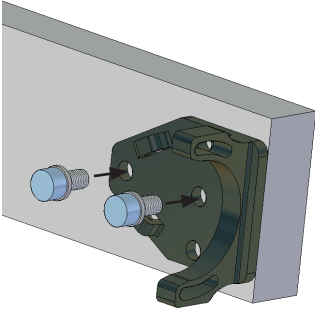

2. Attach the profile mounting.

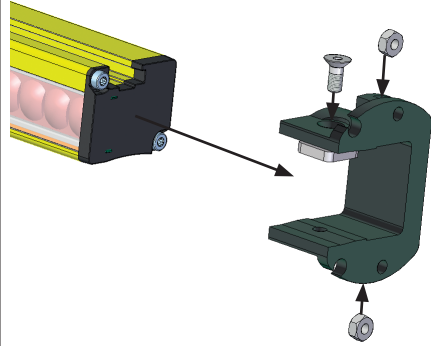

3. Join the wall and profile mountings to each other.

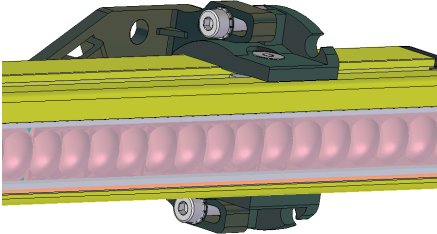

4. Alignment

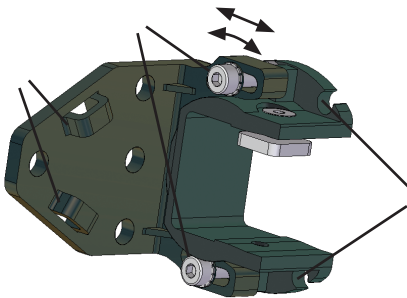

1 Securing the Cable

- The cable can be secured with cable ties.

2 Aligning the ESPE

- Slightly loosen the screws between the wall and profile mountings.
- Align the ESPE.
- Turn the ESPE in the axial direction.
- Adjust ESPE inclination.

3 Securing the Cable

- The cable can be snapped into the openings.

5.3 Securing the Danger Zone

- The danger zone must be secured either by means of the ESPE alone, or by means of the ESPE in combination with additional mechanical safety devices.
- Reaching around, over and/or under the safety field must be prevented.
- It must be impossible to approach the point of danger without passing through the safety field of the ESPE.
- The safety field is located between the point at which light is emitted at the emitter and the point at which light is received at the receiver.
- SFH of the respective ESPE: (see section “3.2 Dimensional Drawings Safety Light Curtain” on page 12)

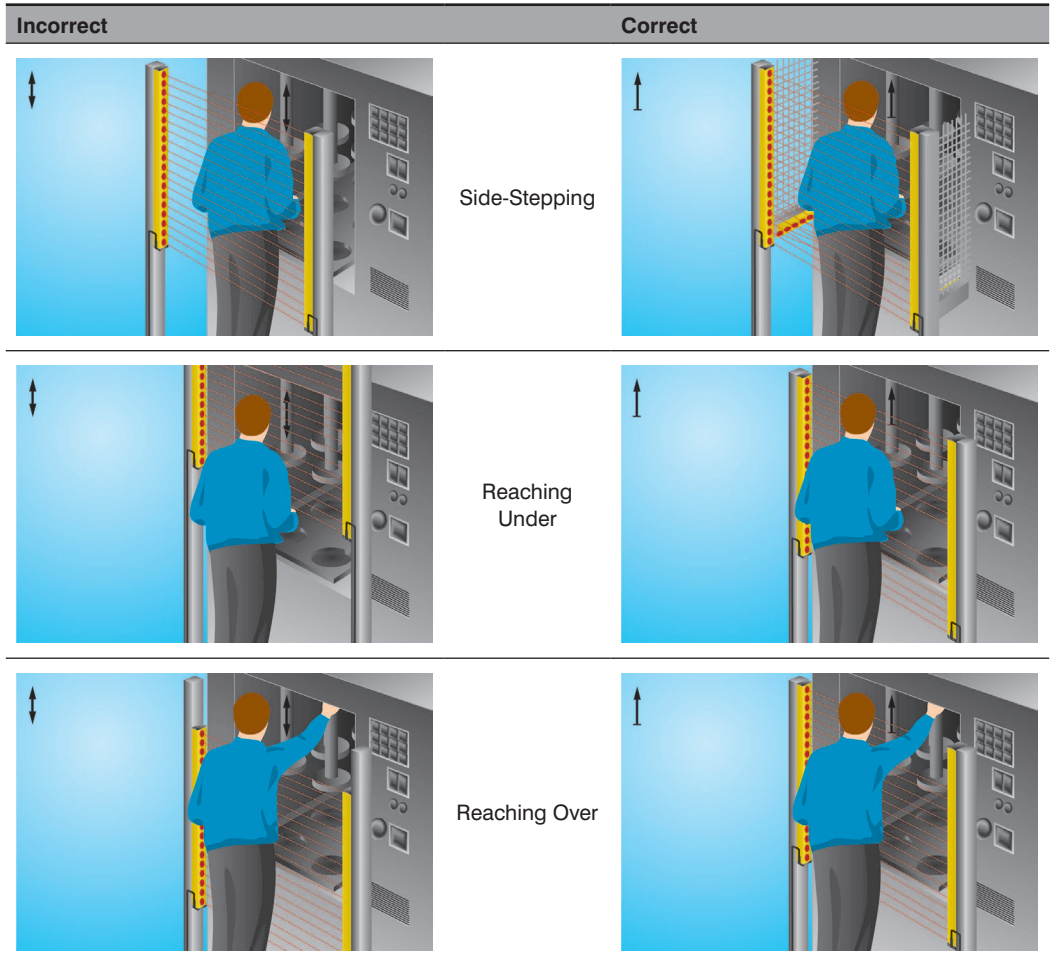

5.4 Safety Clearance



EN ISO 13855 + EN ISO 13857

[abc]

- Safety clearance is the minimum distance between the safety field of the ESPE and the danger zone.
- Safety clearance must be adhered to, in order to assure that the danger zone cannot be reached before hazardous motion is fully stopped.



$$S = (K \times T) + C_{rt} \text{ bzw. } S = K \times (t_1 + t_2) + C_{rt}$$

S [mm]	= safety clearance measured from the danger zone to the safety field
K [mm/s]	= approach speed
T [s]	= total response time ($t_1 + t_2$)
t_1 [s]	= ESPE response time
t_2 [s]	= machine or process overtravel time (overtravel time is specified in the machine's documentation, or must be ascertained by means of measurement)
C_{rt} [mm]	= additional clearance depending upon resolution d with reference to reaching through the ESPE
C_{ro} [mm]	= additional clearance with reference to reaching over an ESPE
d [mm]	= resolution of the ESPE
H [mm]	= reference height, height of the safety field above the floor
a [mm]	= height of the danger zone
b [mm]	= height of the top edge of the safety field

5.4.1 Safety Clearance for Vertical Approach to the Safety Field

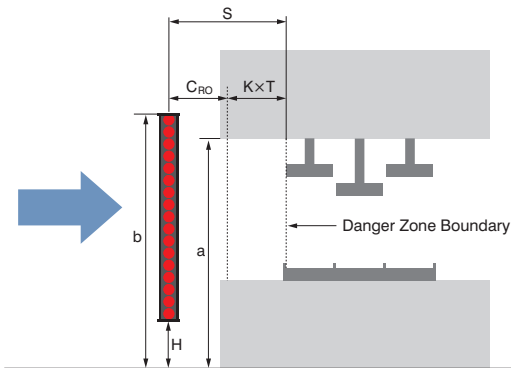

Observe reference height H.

$H \leq 300 \text{ mm} \rightarrow$ avoid danger of undetected access underneath the safety field.

$H < 200 \text{ mm} \rightarrow$ avoid danger of undetected access by children underneath the safety field.

Height of the uppermost beam $\geq 900 \text{ mm} \rightarrow$ prevent danger of stepping over the safety field.



Resolution d	Margin C_{RT}	Approach speed K	Safety clearance S	Note
≥ 14 mm	8 × (d – 14 mm) C = 0 mm (at d = 14 mm)	2000 mm/s (where S ≤ 500 mm)	S = (2000 mm/s × T) + 8 × (d – 14 mm)	S may not be ≤ 100 mm
		1600 mm/s (where S > 500 mm)	S = (1600 mm/s × T) + 8 × (d – 14 mm)	
≥ 30 mm	8 × (d – 14 mm) C = 128 mm (at d = 30 mm)	2000 mm/s (where S ≤ 500 mm)	S = (2000 mm/s × T) + 8 × (d – 14 mm)	S may not be ≤ 150 mm
		1600 mm/s (where S > 500 mm)	S = (1600 mm/s × T) + 8 × (d – 14 mm)	

Prevent Reaching Over the Safety Field

Height of the danger zone a (mm)	Additional horizontal clearance C_{RO} to the danger zone [mm]												
	0	0	0	0	0	0	0	0	0	0	0	0	0
2600	0	0	0	0	0	0	0	0	0	0	0	0	0
2500	400	400	350	300	300	300	300	300	250	150	100	0	0
2400	550	550	550	500	450	450	400	400	300	250	100	0	0
2200	800	750	750	700	650	650	600	550	400	250	0	0	0
2000	950	950	850	850	800	750	700	550	400	0	0	0	0
1800	1100	1100	950	950	850	800	750	550	0	0	0	0	0
1600	1150	1150	1100	1000	900	850	750	450	0	0	0	0	0
1400	1200	1200	1100	1000	900	850	650	0	0	0	0	0	0
1200	1200	1200	1100	1000	850	800	0	0	0	0	0	0	0
1000	1200	1150	1050	950	750	700	0	0	0	0	0	0	0
800	1150	1050	950	800	500	450	0	0	0	0	0	0	0
600	1050	950	750	550	0	0	0	0	0	0	0	0	0
400	900	700	0	0	0	0	0	0	0	0	0	0	0
200	600	0	0	0	0	0	0	0	0	0	0	0	0
0	0	0	0	0	0	0	0	0	0	0	0	0	0
	Height b, top edge of the safety field (mm)												
	900	1000	1100	1200	1300	1400	1600	1800	2000	2200	2400	2600	

NOTE!



- Safety field top-edge heights of less than 900 mm do not provide adequate protection against stepping around or over the safety field.
- Safety field bottom-edge heights of greater than 300 mm do not provide adequate protection against crawling under the safety field.



ESPE response time t_1 = 10 ms
 ESPE resolution d = 30 mm
 Machine overtravel time t_2 = 250 ms
 Danger zone height a = 800 mm

Step 1: Calculate safety clearance for crawling under.

$$S_{RT} = 2000 \text{ mm/s} \times (t_1 + t_2) + C_{RT}$$

$$S_{RT} = 2000 \text{ mm/s} \times (0.25 \text{ s} + 0.01 \text{ s}) + 8 (30 \text{ mm} - 14 \text{ mm})$$

$$S_{RT} = 648 \text{ mm}$$

$$S_{RT} > 500 \text{ mm}, \text{ and thus new calculation with } K = 1600 \text{ mm/s}$$

$$S_{RT} = 1600 \text{ mm/s} \times (0.25 \text{ s} + 0.01 \text{ s}) + 8 (30 \text{ mm} - 14 \text{ mm})$$

$$S_{RT} = 544 \text{ mm}$$

Step 2: Determine additional clearance C_{RO} .

$$S = (K \times T) + C$$

Equating $S_{RO} = S_{RT}$ results in $C_{RO} = C_{RT} = 128 \text{ mm}$

Find $a = 800 \text{ mm}$ in the table titled “Prevent Reaching Over the Safety Field” and take the next smaller value of $C_{RO} = 0 \text{ mm}$.

Step 3: Determine the height of the top edge of the ESPE safety field b .

Take the corresponding value from the table: $b = 1600 \text{ mm}$.

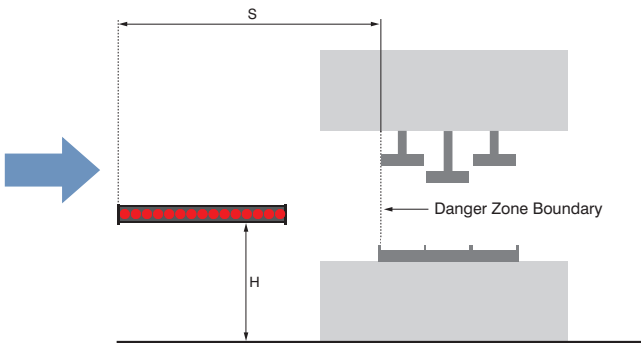

5.4.2 Safety Clearance for horizontal approach to the Safety Field



Reference height H	$200 \text{ mm} < H < 1000 \text{ mm}$	
Minimum height H_{\min}	$H_{\min} = 15 \times (d - 50 \text{ mm})$	$H \geq 0 \text{ mm}$
Margin C	$C = 1200 \text{ mm} - 0.4 \times H$ $C_{\min} \geq 850 \text{ mm}$	
Approach speed K	1600 mm/s	
Resulting resolution d	$d = (H/15) + 50 \text{ mm}$	Required resolution must be calculated for the specified height.
Safety clearance S	$S = (1600 \text{ mm/s} \times T) + (1200 \text{ mm} - 0.4 \times H)$	S may not be $\leq 850 \text{ mm}$. S is between the danger zone and the furthest beam of the sensor.

Example:

- ESPE response time = 10 ms
- ESPE resolution = 14 mm
- Machine over-travel time = 330 ms
- Reference height = 500 mm
 $S = 1600 \text{ mm/s} \times (0.33 \text{ s} + 0.01 \text{ s}) + 1200 \text{ mm} - (0.4 \times 500 \text{ mm})$
 $S = 1544 \text{ mm}$
- Resultant resolution $d = (500 \text{ mm}/15) + 50 \text{ mm} = 83.3 \text{ mm}$

5.4.3 Safety Clearance for Angular Approach to the Safety Field

For applications where $5^\circ < \alpha < 85^\circ$

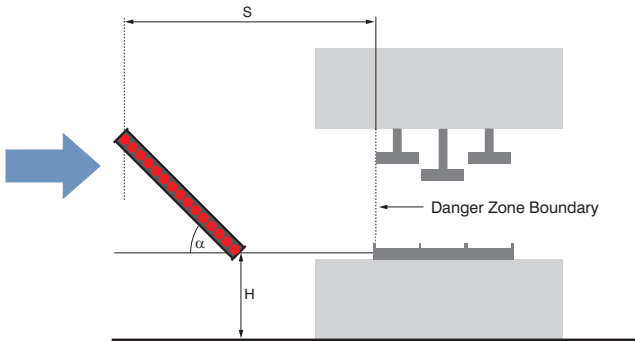

	$\alpha > 30^\circ$	$\alpha < 30^\circ$
Calculation based on	Vertical approach	Horizontal approach
Safety clearance refers to	Distance between the point of danger and the closest light beam	Distance between the point of danger and the furthest light beam
Note		<p>The height of the furthest light beam may not be ≤ 1000 mm.</p> <p>The following applies to the closest light beam: $H = 15 \times (d - 50 \text{ mm})$ and $d = H/15 + 50 \text{ mm}$</p>

5.5 Clearance from Reflective Surfaces



NOTE!

- Reflective surfaces located within the aperture angle between the emitter and the receiver may counteract the system's safety function.
- Minimum clearance (m) from reflective surfaces to the optical axis must be adhered to.



IEC 61496-2



$$m = \tan \alpha \times \text{safety field width}$$

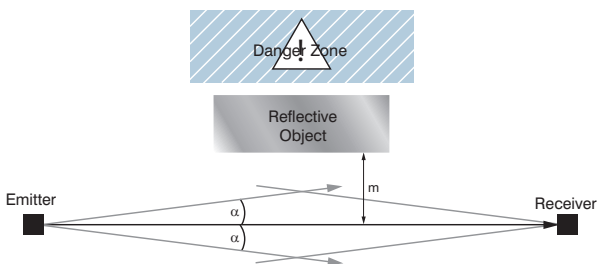

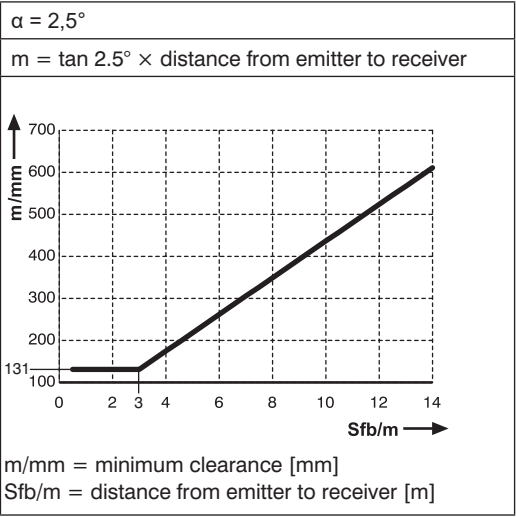

5.6 Multiple Systems

NOTE!



- Reciprocal influence of neighboring ESPEs may counteract the system's safety function.
- Only the light from the associated emitter may strike the receiver.
- Measures for the prevention of mutual influence in multiple systems:
 - Non-parallel arrangement (see figure)
 - Lateral clearance = $2 \times m$ (see section "5.5 Clearance from reflective Surfaces" on page 29)
 - Screening (e.g. by means of partitions)

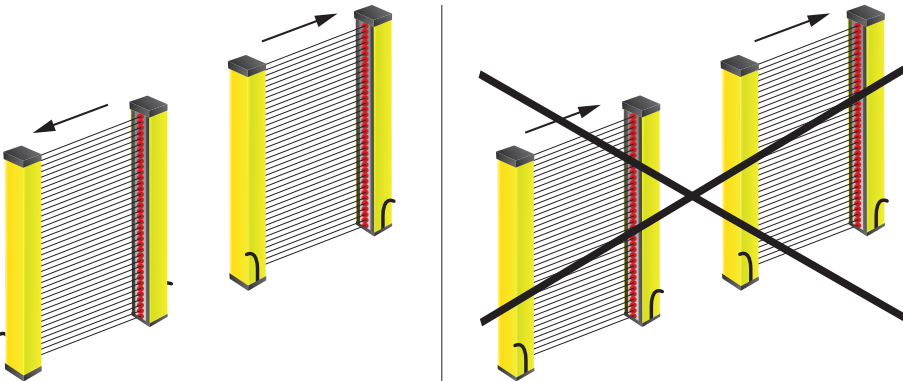

- In the case of Safety Light Curtains with hand protection, a consistent resolution of 30 mm, and thus an enlarged safety field can be achieved by arranging two sensors in a row. The following requirements must be adhered to:
 - Both sensors must have a resolution of 30 mm.
 - The sensors are positioned one on top of the other without any gap at the end of the device (cable connection).
 - The sensors are arranged non-parallel so that reciprocal influence is prevented.

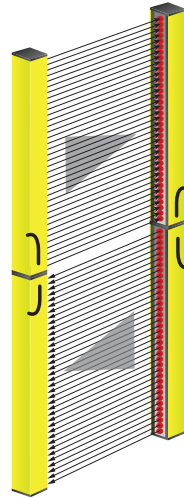

5.7 Deflection Mirror

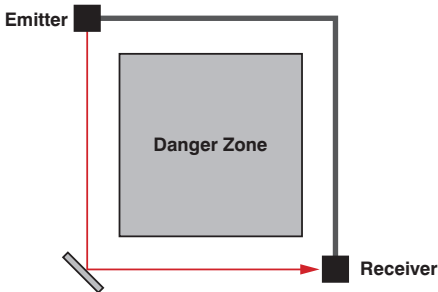

The range of possible applications can be significantly expanded through the use of a Deflection Mirror.

Deflection Mirrors are available in two different variants:

- Z2UGxxx without housing
- SZ000EUxxxNN01 with Protection Column

A danger zone can be secured on several sides using only one Safety Light Curtain with the help of wenglor Deflection Mirrors. Range is reduced by approximately 10% per mirror.

Further system components can be found in [section „3.5 Complementary Products“](#) on page 16 and in [section „5.1 System Overview“](#) on page 20.

5.8 Electrical Connection

- Both safety outputs, OSSD1 and OSSD2, must be incorporated into the machine's power circuit.
- Functional earth can be optionally connected.



NOTE!

Selectable functions are chosen by means of corresponding wiring (see section "7.1 Initial Start-Up" on page 37 and see section "7.2 Overview of All Functions" on page 43).

5.9 Optical Alignment

Prealignment:

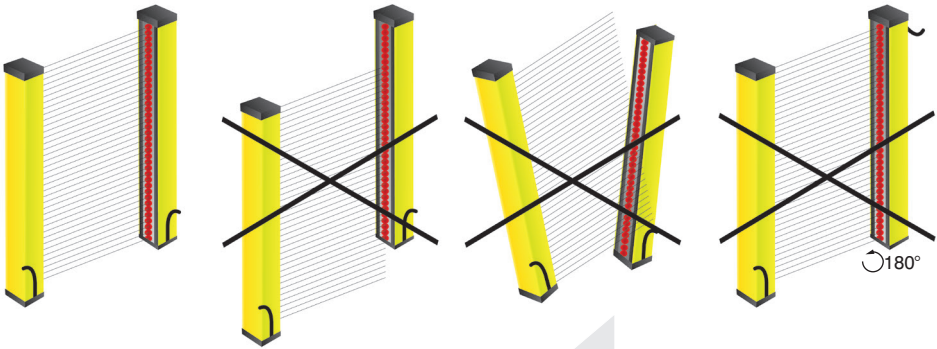

View from Above

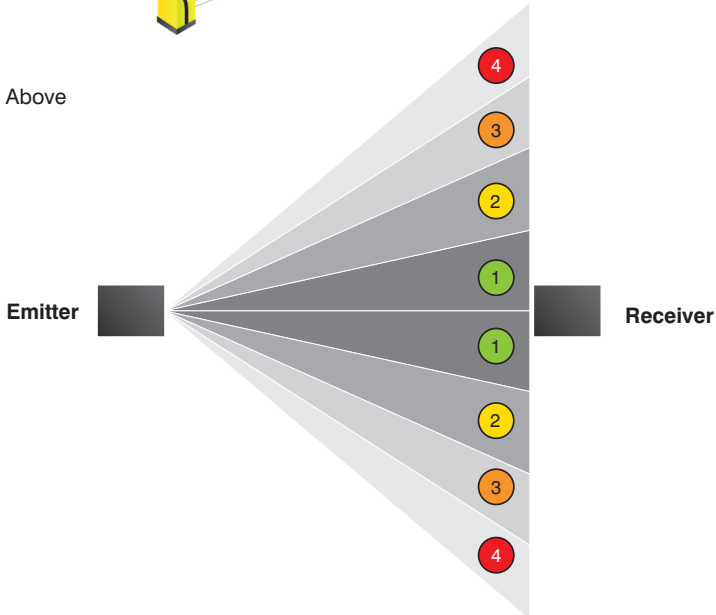

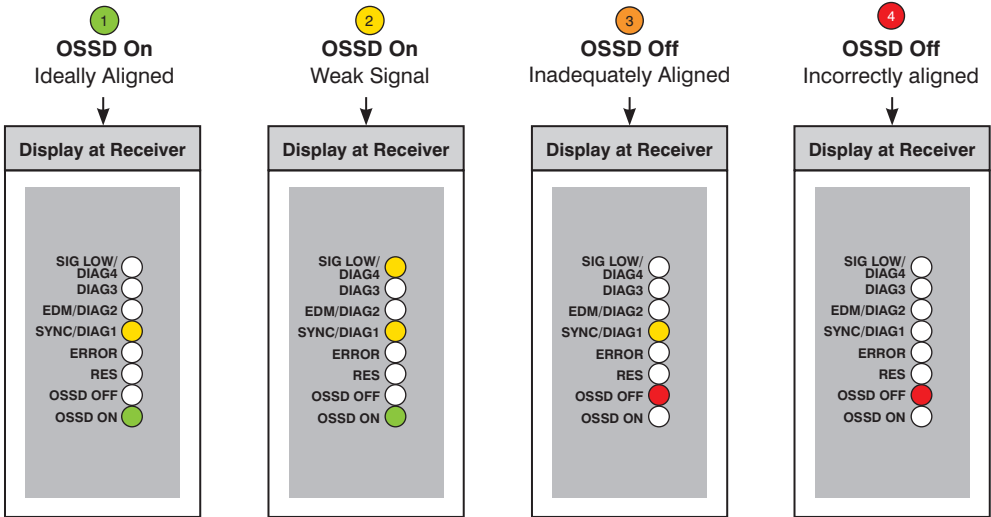

5.10 Diagnostics

Conduct in case of fault:



NOTE!

- Shut down the machine.
- Analyze and eliminate the cause of error on the basis of the diagnostics information (see section “12.4 Display in Case of Error” on page 65).
- If the error cannot be eliminated, please contact wenglor’s support department.

DANGER!

Risk of personal injury or property damage in case of non-compliance!

The system’s safety function is disabled. Personal injury and damage to equipment.



- Do not operate in case of indeterminate malfunctioning.
- The machine must be shut down if the error cannot be unequivocally clarified or reliably eliminated.
- Conduct in case of fault as specified

- Displays which appear during normal operation are included in the appendix (see section “12.3 Display during Normal Operation” on page 62).
- Displays which appear in the event of an error are included in the appendix (see section “12.4 Display in Case of Error” on page 65).

6. Functions

6.1 Default Settings

Device	Function	Default Setting
Receiver	Safety mode	Active (in the case of appropriate wiring)
	Start-up and restart inhibit	Inactive, is activated automatically by means of appropriate wiring
	Contactor monitoring	Inactive, is activated automatically by means of appropriate wiring
Emitter	Test function	Inactive, is activated when triggered during operation
	Range	High range (in the case of appropriate wiring)

6.2 Function definition

Safety Mode (automatic operation)

[abc]

- In this operating mode, the switching outputs are disabled when the safety field is interrupted. The switching outputs are automatically enabled after interrupted of the safety field is ended.

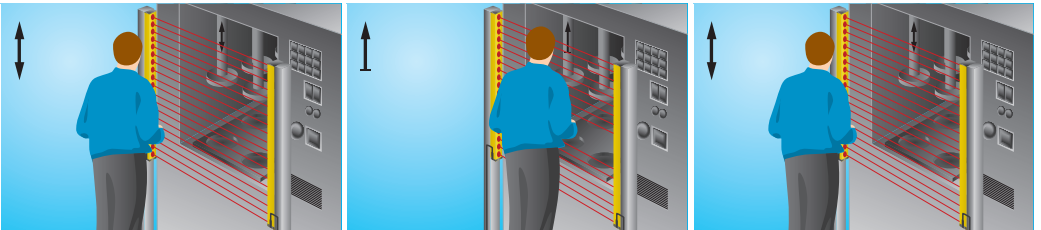

NOTE!

- Determine whether or not safety mode operation is permissible for the respective application.

Start-Up and Restart Inhibit

[abc]

- Start-up inhibit is activated along with the → restart inhibit function. When supply power is switched on (e.g. after a power failure), the safety outputs (OSSD) remain in the off state. Acknowledgement is accomplished by activating an acknowledgment key.
- Restart inhibit prevents a machine from starting back up automatically after the safety field has been interrupted. The machine can only be re-enabled by activating an acknowledgment key.

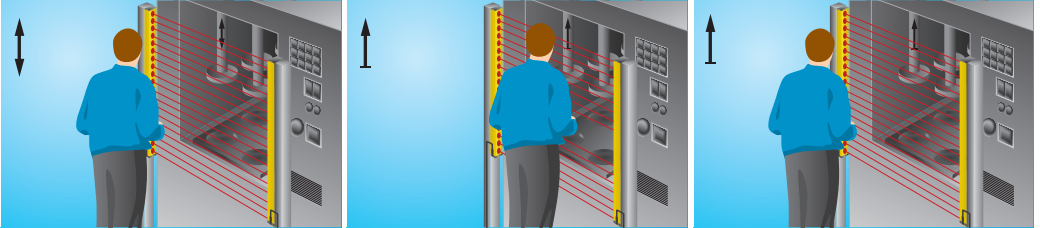

NOTE!

- The acknowledgment key must be mounted outside of the danger zone.
- The user must be able to see into the danger zone in an unobstructed fashion when activating the acknowledgement key.

Contacting Monitoring

[abc]

- Contacting monitoring is a function for which switching performance of the contacts at an external relay is dynamically monitored. The contacts must close fully within a specified period of time.
- Switching devices equipped with positively-driven NC contacts are a prerequisite for this function.

Signal Output

[abc]

- The signal output is a semiconductor output for auxiliary functions without safety monitoring.
- Additional read-out function: acknowledgment prompt.

Test Function

[abc]

- If the test input is connected to plus, the transmission function is deactivated. The sensor can thus be tested for correct functioning. If the input is open or connected to minus, the transmission function is activated.

NOTE!



- The ESPE is self-testing. No external test is required.
- Max. valid test duration: < 150 ms
- A test duration of ≥ 150 ms results in a warning (see section “12.3.2 Emitter” on page 64)
- A test duration of > 10 s results in an error (see section “12.4.2 Emitter” on page 67)

Synchronization

- The emitter and the receiver are synchronized by means of optical synchronization beams. These are the upper and lowermost beams.

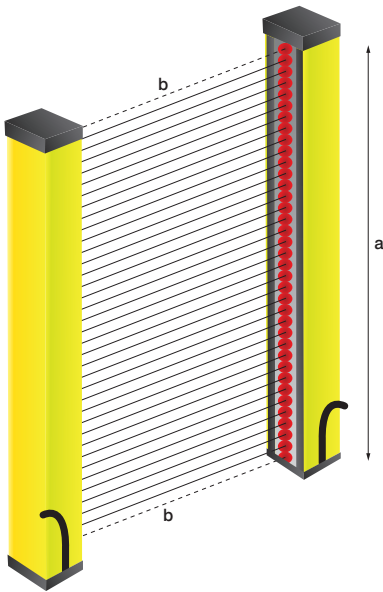

a = safety field height

b = synchronization beams

7. Settings

7.1 Initial Start-Up



NOTE!

- For easy set-up and alignment, first select "safety mode without contactor monitoring".
- Perform all adjustments without supply power.

General procedure:

1. Adjust the emitter.
2. Adjust the receiver.
3. Align the sensor optically.
4. Adjust other functions as required.
5. Safety Light Curtain ready for operation

Initial Start-Up Procedure

1. Adjust the emitter.

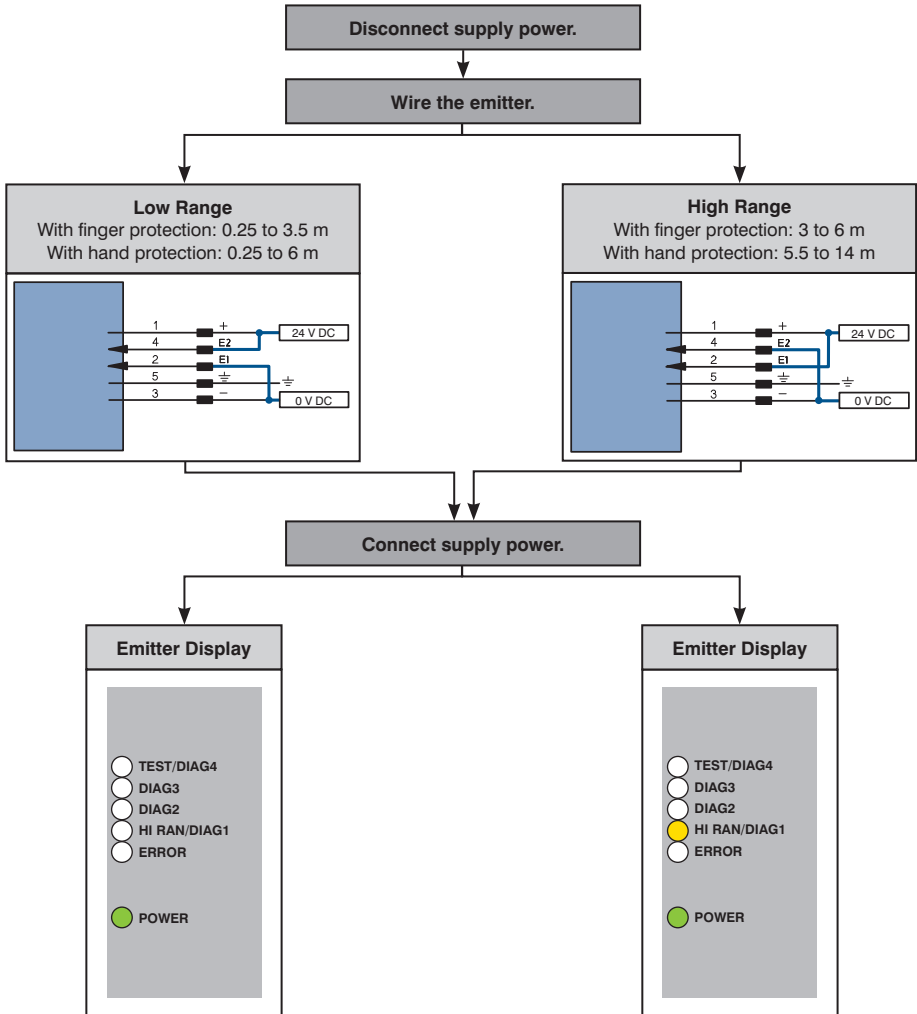

2. Adjust the receiver.

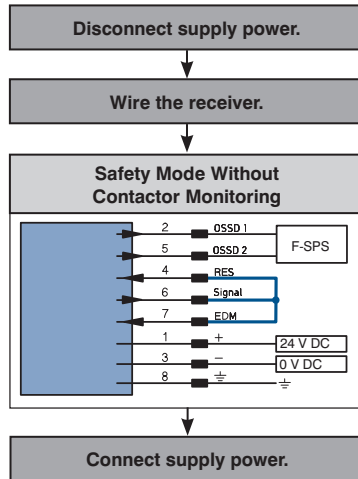

3. Align the sensor optically.

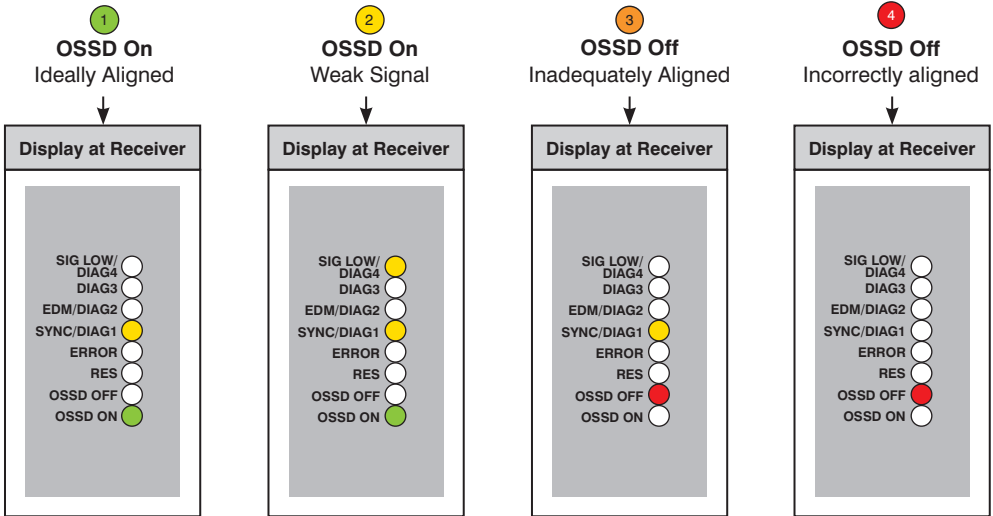
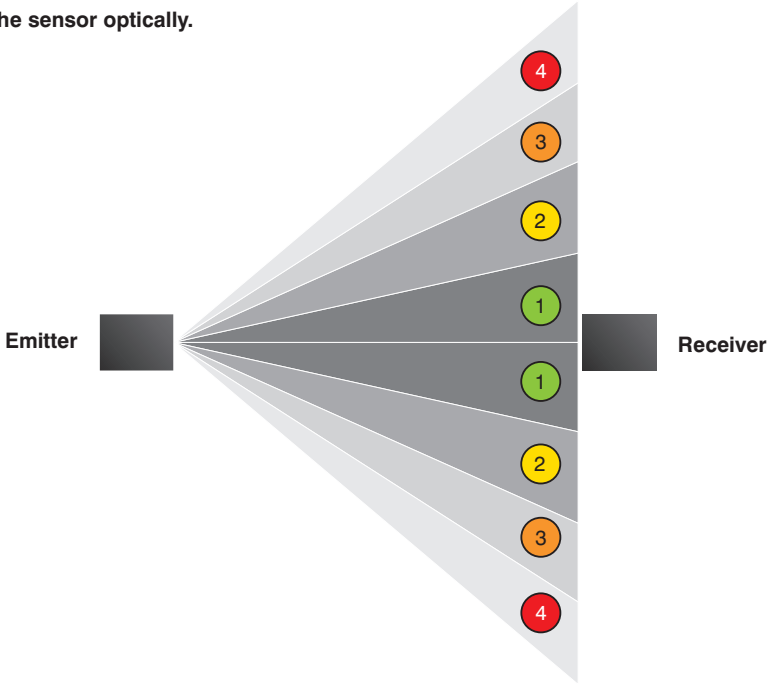

When the maximum range of the sensors is exploited, "SIG LOW/DIAG4" may appear at the display even if they are ideally aligned.

The illustration applies to the safety mode without contactor monitoring.

4. Adjust other functions as required.

Select from:

- Safety mode with contactor monitoring
- Start-up and restart inhibit without contactor monitoring
- Start-up and restart inhibit with contactor monitoring (see page 42)

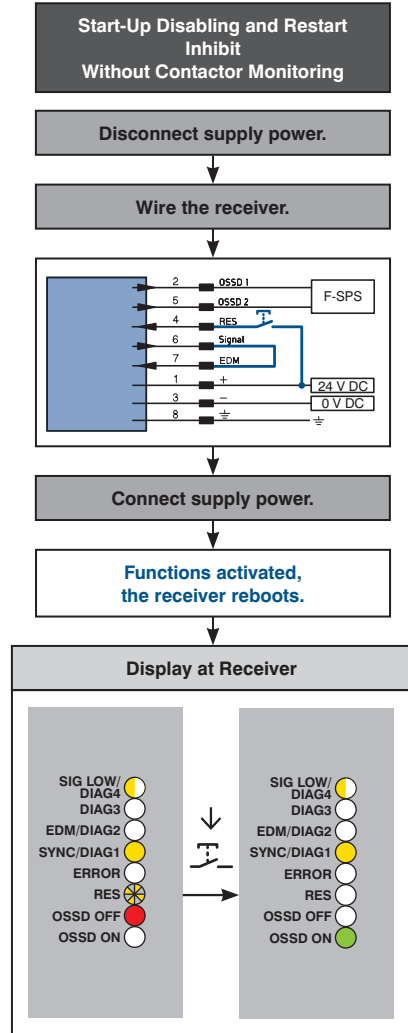
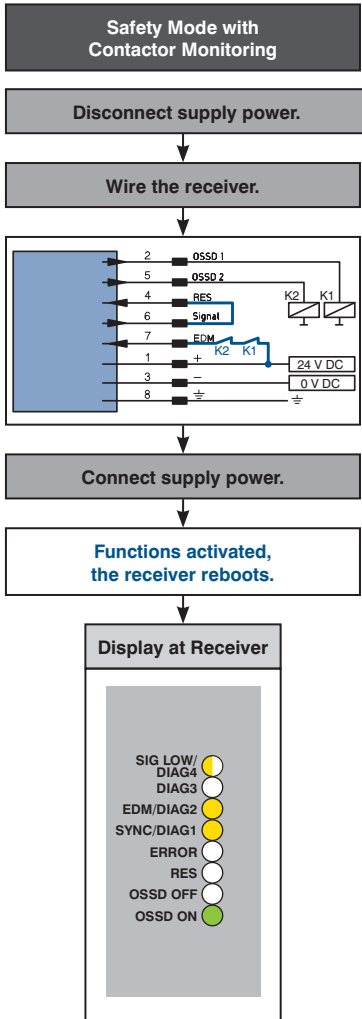

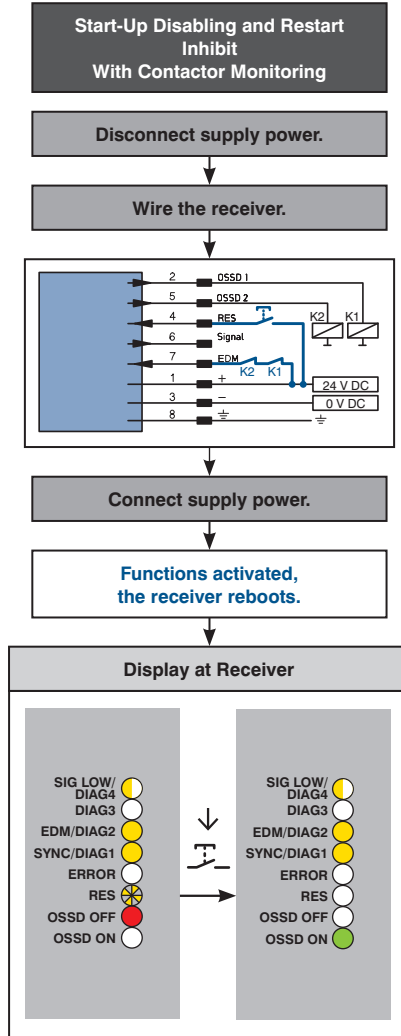

5. Safety Light Curtain ready for operation

7.2 Overview of All Functions

Emitter Settings		Receiver Settings	
Range	section 7.3	Safety mode without contactor monitoring	section 7.4
Test function	section 7.9	Safety mode with contactor monitoring	section 7.5
		Start-up and restart inhibit without contactor monitoring	section 7.6
		Start-up and restart inhibit with contactor monitoring	section 7.7
		Signal output	section 7.8



NOTE!

In order to accept the modified configuration, a test object must be passed through the safety field (beginning at the sensor connection on the control panel side up to the other end) within 30 seconds after electrical connection and activation of supply voltage. Interruption is confirmed by LED DIAG3 at the receiver.

This is always necessary when switching to a “less safe” operating mode:

- From restart inhibit to safety mode
- From contactor monitoring to operation without contactor monitoring

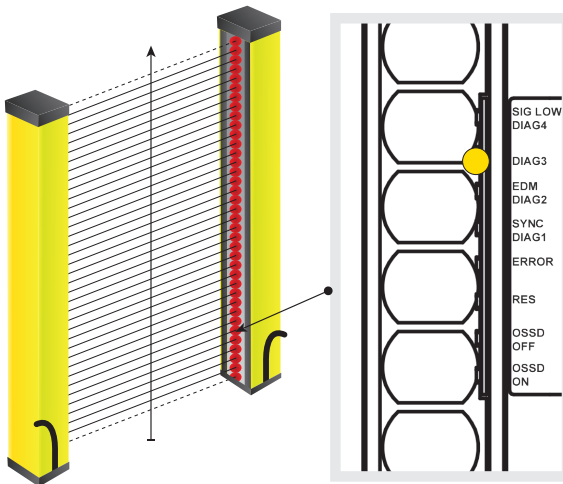

An overview of parameters configuration for the receiver is included in the index (see section “12.2 Overview of Receiver Parameters Configuration” on page 62).

7.3 Adjusting Range



DANGER!

Risk of personal injury or property damage in case of incorrectly adjusted range!

The range setting is safety relevant. If it's set too high, **bleed-over reflection may occur.**

- Range must be suitably adjusted for each respective application.

7.3.1 Low Range

- Low range with 14 mm resolution: 0.25 to 3.5 m
- Low range with 30 mm resolution: 0.25 to 6 m

Procedure:

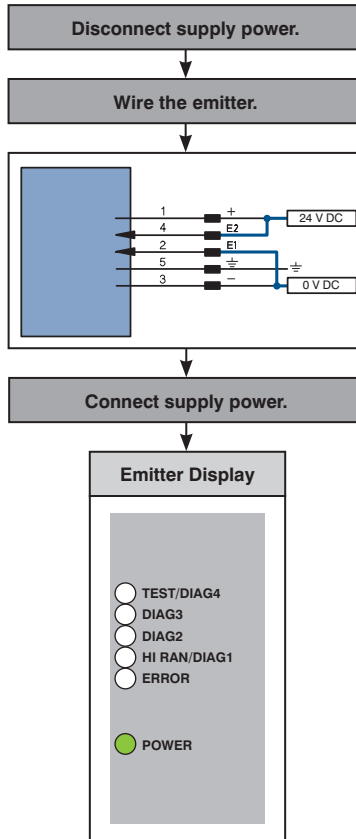

7.3.2 High Range

- High range with 14 mm resolution: 3 to 6 m
- High range with 30 mm resolution: 5.5 to 14 m

Procedure:

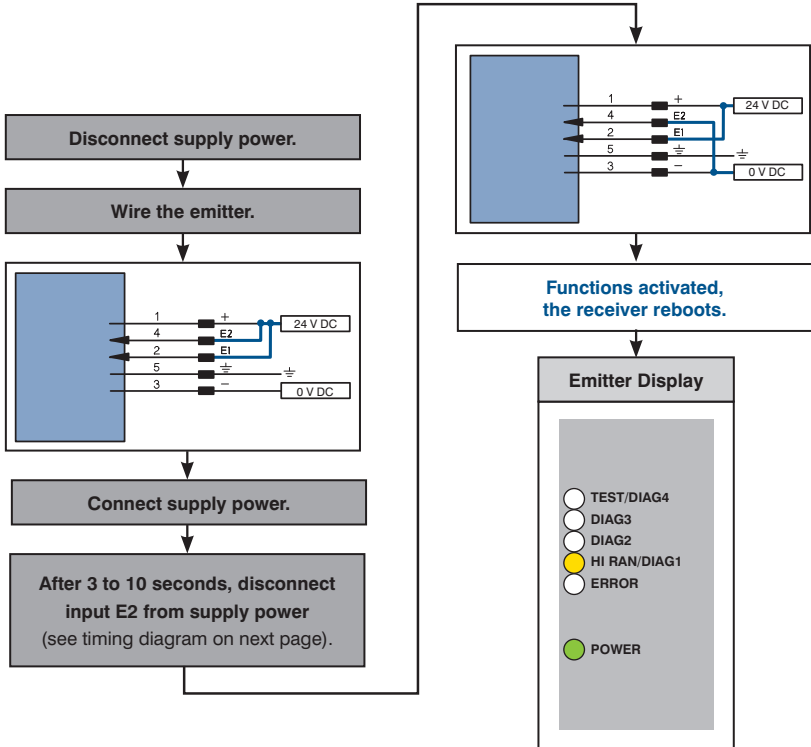

Timing Diagram

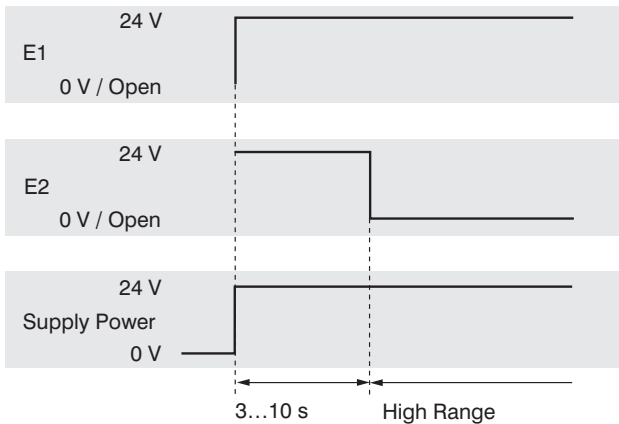

7.4 Safety Mode Without Contactor Monitoring

Procedure:

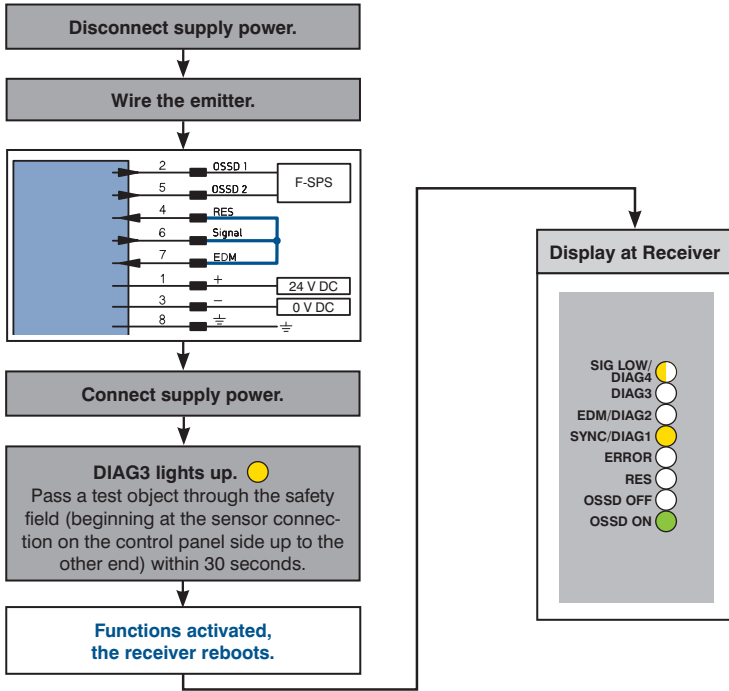

Timing Diagram

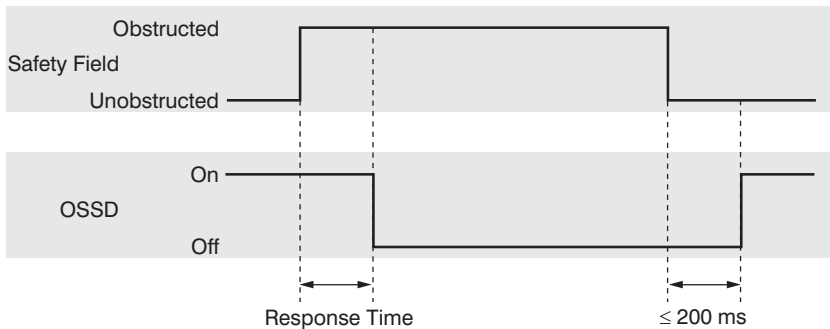

7.5 Safety Mode With Contactor Monitoring



NOTE!

Make sure that the ESPE is ideally aligned. This is easiest to see in the “safety mode without contactor monitoring” configuration (see section “7.1 Initial Start-Up” on page 37).

Procedure:

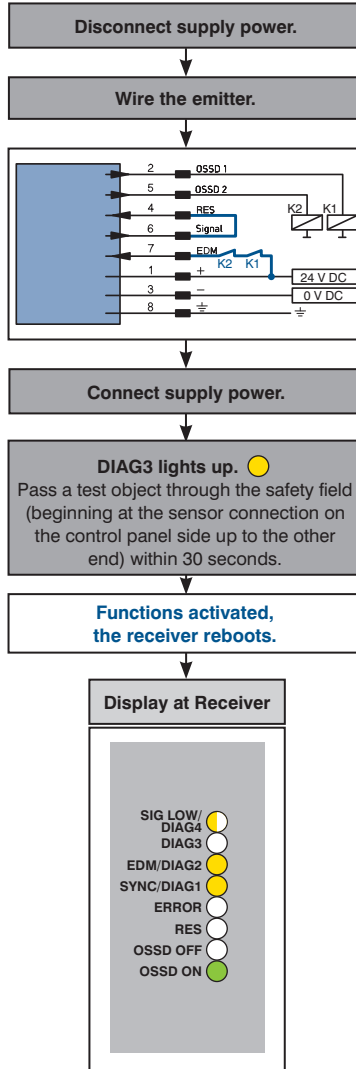

Timing Diagrams

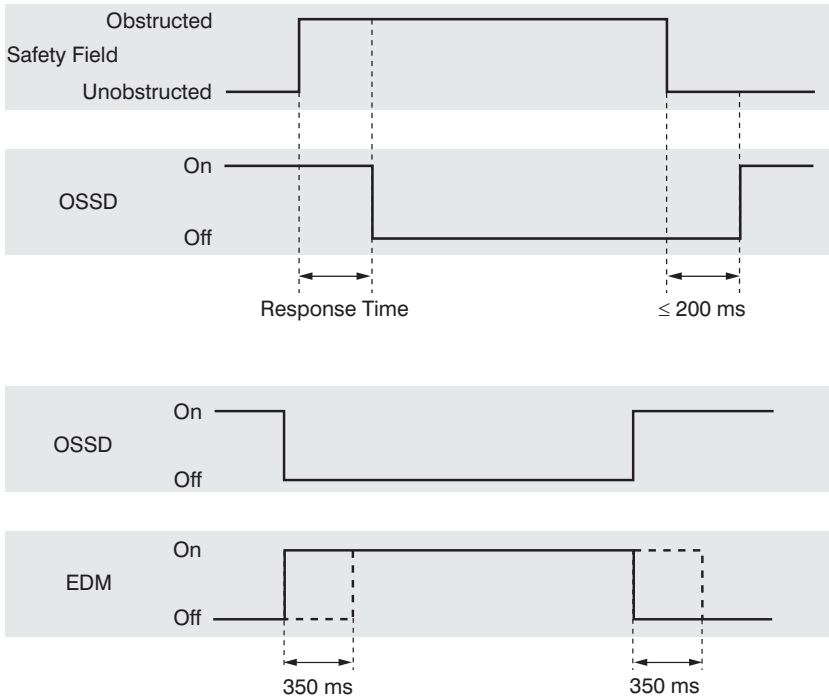

7.6 Start-Up and Restart Inhibit Without Contactor Monitoring



NOTE!

Make sure that the ESPE is ideally aligned. This is easiest to see in the “safety mode without contactor monitoring” configuration (see section “7.1 Initial Start-Up” on page 37).

Procedure:

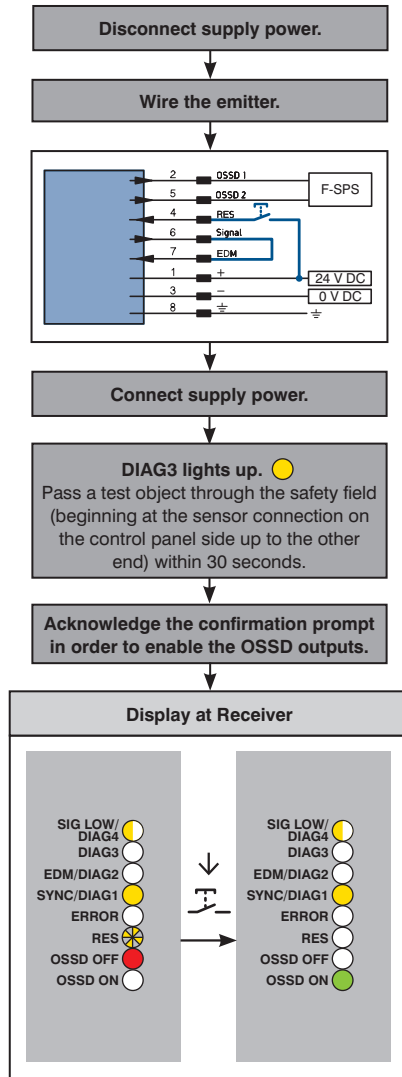

Timing Diagram

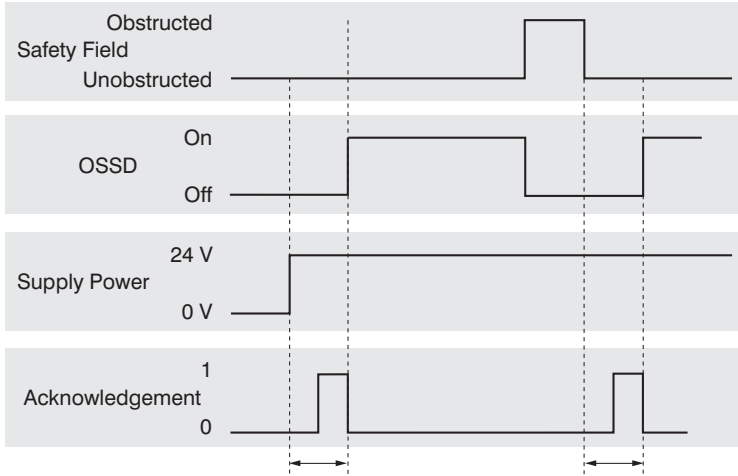

Acknowledgement duration: 0.1 to 4 seconds (see technical data)



NOTE!

- DIAG3 only lights up if restart inhibit with contactor monitoring has been previously selected.
- If the Light Curtain was previously configured for “safety mode with contactor monitoring” or “safety mode without contactor monitoring”, the LED does not light up.

7.7 Start-Up and Restart Inhibit With Contactor Monitoring



NOTE!

- Make sure that the ESPE is ideally aligned. This is easiest to see in the “safety mode without contactor monitoring” configuration (see section “7.1 Initial Start-Up” on page 37).

Procedure:

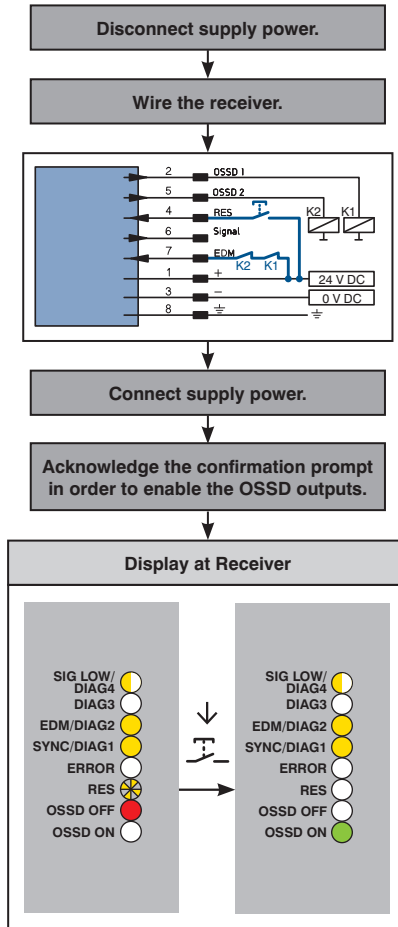

Timing Diagrams

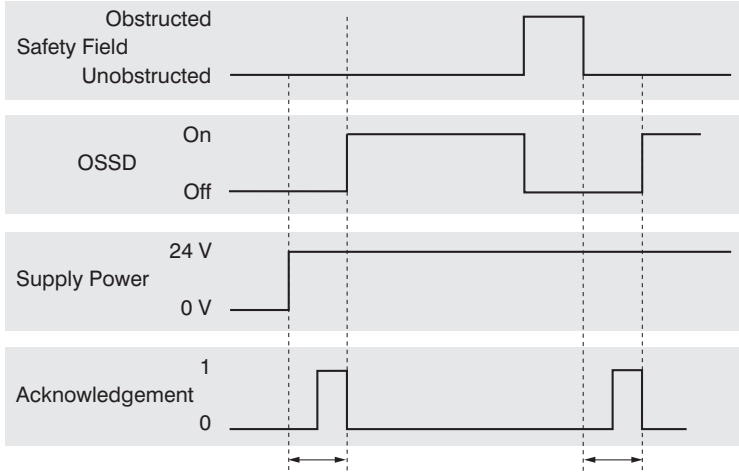

Acknowledgement duration: 0.1 to 4 seconds (see technical data)

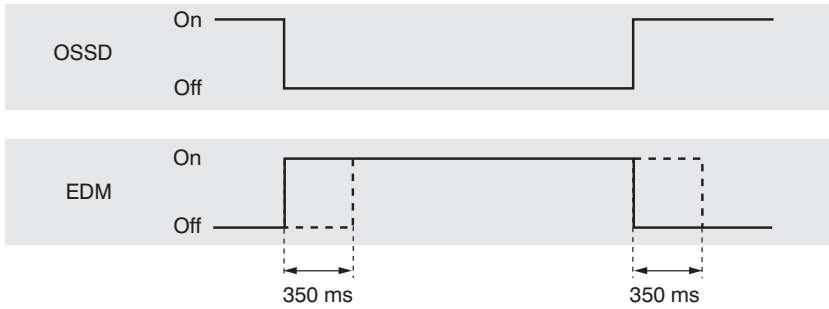

7.8 Signal output



NOTE!

- The signal output provides information indicating whether or not an acknowledgement request is pending (with active start-up or restart inhibit).

Procedure:

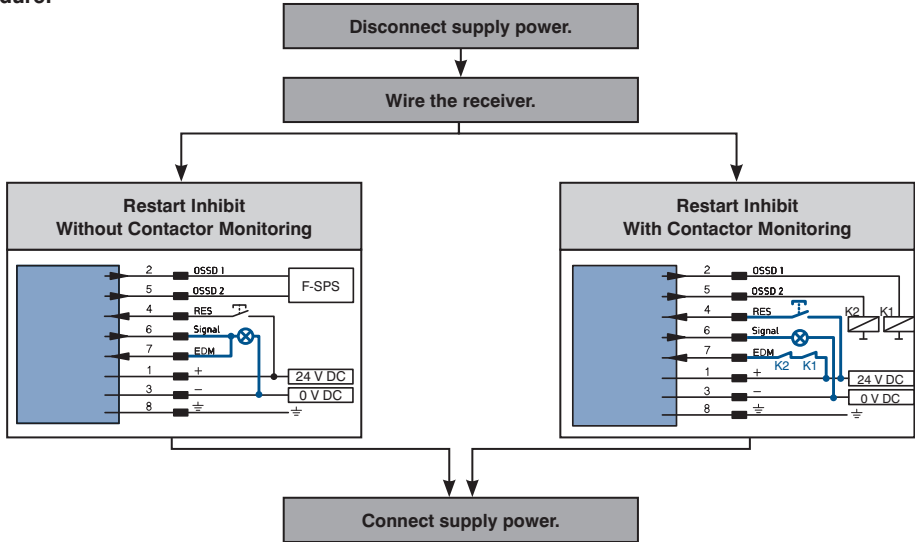

Timing Diagram

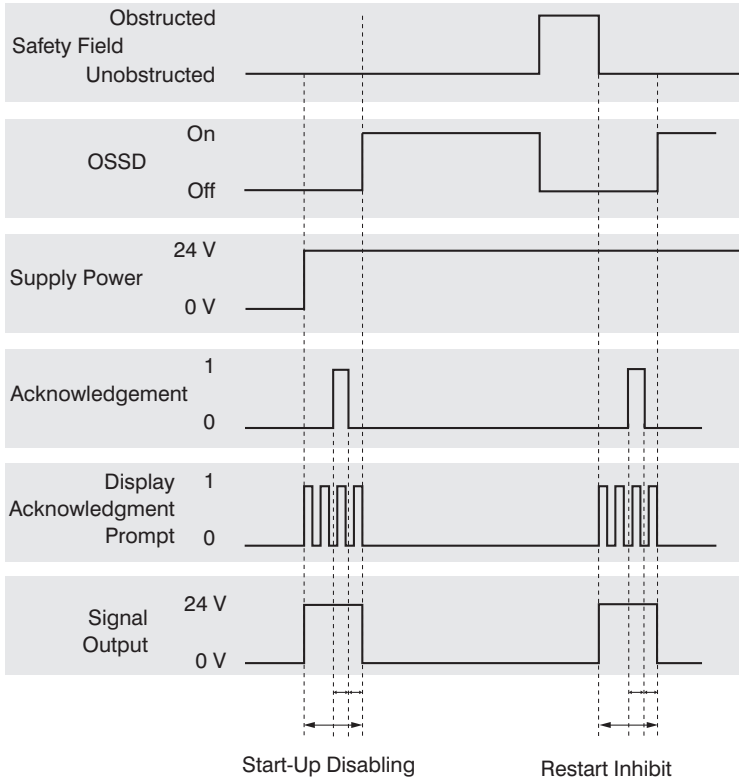

t_1 - Acknowledgement duration: 0.1 to 4 s t_2 - On-time: 30 to 120 ms

7.9 Test Function

Procedure:

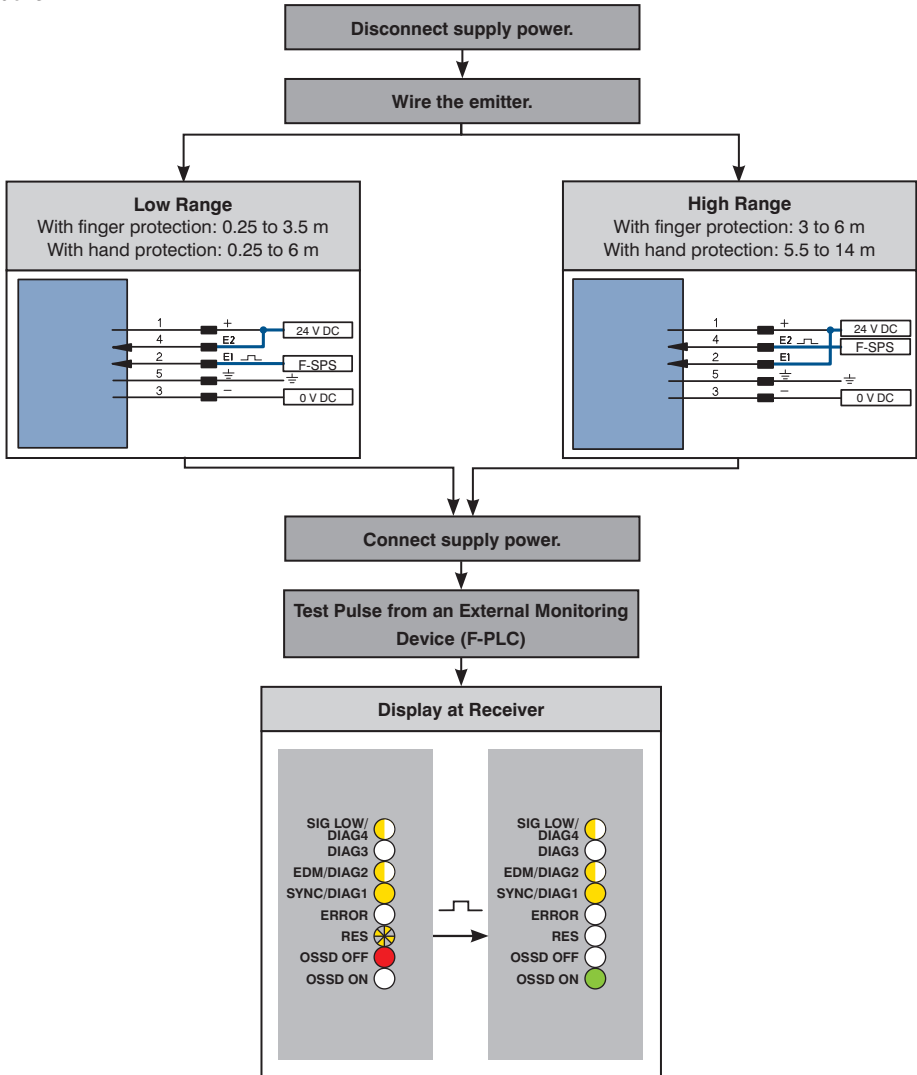

Timing Diagram

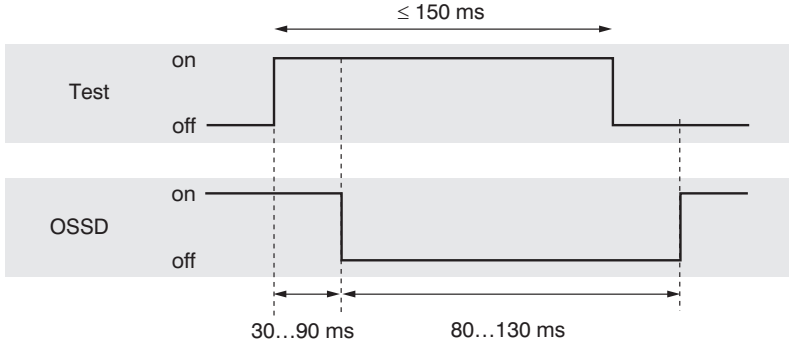

7.10 Restoring Default Settings

If the desired configuration has been interrupted (error, timeout etc.), the sensor can be returned to its default settings with the help of the following procedure.

Emitter

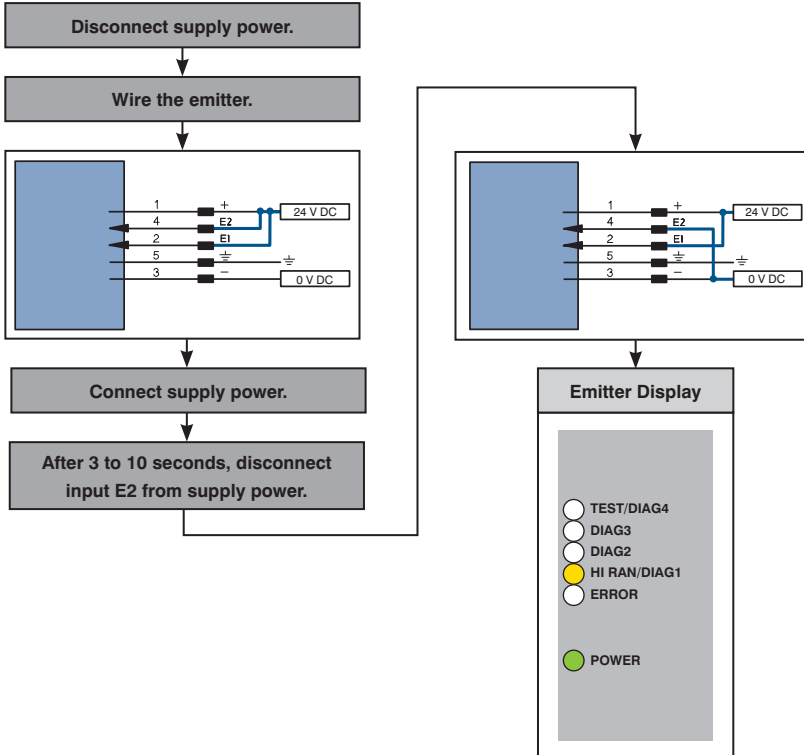

Receiver

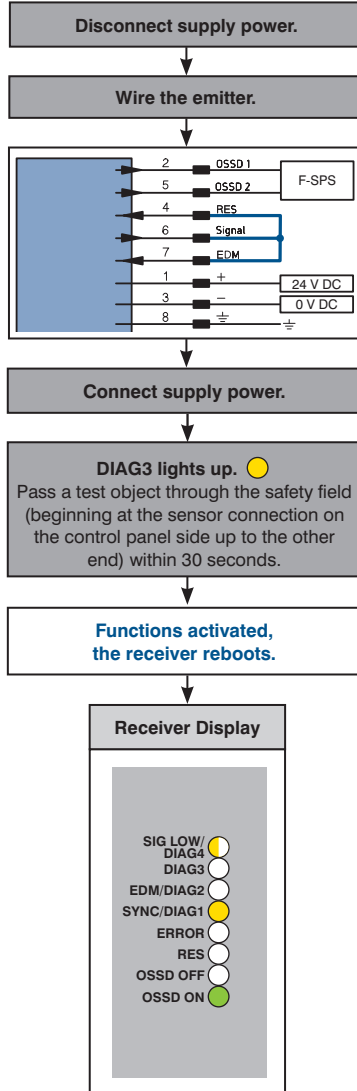

8. Testing

8.1 Testing Prior to Initial Start-Up



- Inspection to assure that the ESPE has been correctly selected in accordance with local ordinances, and testing to assure that they provide the required protection when used for their intended purpose.

Execute testing:

- Prior to initial start-up
- After making changes to the machine
- After the machine has been shut down for a lengthy period of time
- After modifying or repairing the machine



NOTE!

- Observe regulations regarding the training of operating personnel by experts before they begin work.
- The company which operates the machine is responsible for training.

Testing

Effectiveness of the ESPE must be assured in all operating modes which can be selected at the machine.

- Testing according to checklist ([see section “12.5 Initial Start-Up Checklist” on page 68](#)).



NOTE!

- Work at the machine must be immediately stopped if any impairment of the safety function is detected.
- If the safety function is impaired, test the effectiveness of the ESPE at the machine once again in accordance with the checklist ([see section “12.5 Initial Start-Up Checklist” on page 68](#)).

8.2 Annual Inspection



Inspection once a year or before expiration of deadlines specified by applicable national regulations.

Inspection

	The machine has not undergone any changes or manipulations which might affect the safety system.
	The ESPE has not undergone any changes or manipulations which might affect the safety system.
	The ESPE is correctly connected to the machine.
	The machine's response time (including ESPE) has not increased in comparison with response time during initial start-up.
	Cables, plugs and mounting components must be in flawless condition.

NOTE!



- Work at the machine must be immediately stopped if any impairment of the safety function is detected.
- If the safety function is impaired, test the effectiveness of the ESPE at the machine once again in accordance with the checklist ([see section "12.5 Initial Start-Up Checklist" on page 68](#)).

8.3 Daily Inspection



Daily inspections must be conducted by a person who has been authorized and engaged to do so by the company which operates the machine when work begins, and whenever a new shift is started.

Inspection

	The ESPE may not demonstrate any visible damage.
	The lens cover may not be scratched or contaminated.
	It must be impossible to approach the danger zone without passing through the safety field of the ESPE.
	Cables, plugs and mounting components must be in flawless condition.

Testing the effectiveness of the ESPE:

- Testing may only be conducted when hazardous motion has been switched off.
- Testing must be conducted with a test rod, and not by reaching in with the hand.
- Test rod diameter: in accordance with ESPE resolution



Testing the “automatic start-up function” (safety mode):

- The OSSD ON display must light up before testing is started.
- Pass the test rod through the entire safety field as shown in the figure.
- The OSSD OFF display must be lit up as long as the test rod is in the safety field.



Testing the “restart inhibit” function:

- The RES display must blink before testing is started.
- Pass the test rod through the safety field as shown in the figure.
- The OSSD OFF display must remain lit up as long as the test rod is in the safety field.
- The RES display may not light up as long as the test rod is in the safety field.

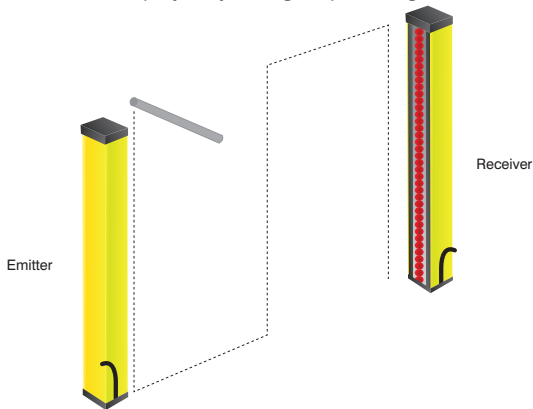

NOTE!

- Work at the machine must be immediately stopped if any impairment of the safety function is detected.
- Do not clean with solvents or cleansers which could damage the device.
- Attach the included sticker, “Important Instructions for Daily Inspection”, in direct proximity to the associated Safety Light Curtain



9. Maintenance



NOTE!

- This wenglor sensor is maintenance-free.
- Instructions regarding annual (see section “8.2 Annual Inspection” on page 59) and daily inspection (see section “8.3 Daily Inspection” on page 59) must be adhered to.

10. Shutdown

The sensor must be disconnected from supply power for shutdown. The sensor neither contains nor gives off any environmentally harmful substances. It consumes only a minimum of energy and resources.

11. Proper Disposal

wenglor sensoric GmbH does not accept the return of unusable or irreparable products. Respectively valid national waste disposal regulations apply to product disposal.

12. Appendix

12.1 Change Index, Operating Instructions

Version	Date	Description/Change
03	21.01.2015	Initial version of the operating instructions
04	27.08.2015	Revised acknowledgment duration
05	25.11.2015	Revised layout (new structuring)
		Addenda to “For Your Safety” (section 2)
		Addenda to “Transport and Storage” (section 4)
		Addenda to “System Overview” (section 5.1)
		Addenda to “Flowchart for Initial Start-Up” (section 7.1)
		Addenda to “Overview of Receiver Parameters Configuration” (section 12.2)
		Addenda to “Connection Examples” (section 12.6)
06	04.05.2016	Revised EU declaration of conformity (section 12.7)
07	12.12.2016	Graphic for optical alignment revised
08	11.07.2019	Revised EU declaration of conformity (section 12.7)

12.2 Overview of Receiver Parameters Configuration

































The receiver's parameters are configured by means of corresponding wiring of pins 4, 6 and 7.

	Safety Mode Without EDM	Safety Mode With EDM	RES Without EDM	RES With EDM
	section 7.4	section 7.5	section 7.6	section 7.1
Pin 4 (RES)	Jumper to pin 6	Jumper to pin 6	24 V via pushbutton	24 V via pushbutton
Pin 6 (signal output)	–	–	Optionally to PLC or signaling module	Optionally to PLC or signaling module
Pin 7 (EDM)	Jumper to pin 6	24 V via closed feedback loop	Jumper to pin 6	24 V via closed feedback loop

12.3 Display during Normal Operation

12.3.1 Receiver

Display	Description
	<ul style="list-style-type: none"> Receiver and emitter are not synchronized.
	<ul style="list-style-type: none"> Emitter and receiver synchronized. Not all beams are detected.

<ul style="list-style-type: none"> SIG LOW/DIAG4  DIAG3  EDM/DIAG2  SYNC/DIAG1  ERROR  RES  OSSD OFF  OSSD ON  	<ul style="list-style-type: none"> • OSSD is activated. • Receiver and emitter are synchronized. • All beams are detected. • Safety mode or start-up and restart inhibit is active. • Contactor monitoring is active. EDM/DIAG2  • Contactor monitoring is inactive. EDM/DIAG2  • Ideally aligned SIG LOW/DIAG4  • Weak signal SIG LOW/DIAG4 
<ul style="list-style-type: none"> SIG LOW/DIAG4  DIAG3  EDM/DIAG2  SYNC/DIAG1  ERROR  RES  OSSD OFF  OSSD ON  	<ul style="list-style-type: none"> • OSSD is off • Receiver and emitter are synchronized. • Start-up and restart inhibit is active. • Acknowledgment prompt • Contactor monitoring is active EDM/DIAG2  • Contactor monitoring is inactive EDM/DIAG2  • Ideally aligned SIG LOW/DIAG4  • Weak signal SIG LOW/DIAG4 
<ul style="list-style-type: none"> SIG LOW/DIAG4  DIAG3  EDM/DIAG2  SYNC/DIAG1  ERROR  RES  OSSD OFF  OSSD ON  	<ul style="list-style-type: none"> • OSSD is off • Beam interruption through the entire safety field is required from the cable connection to other end. • Contactor monitoring is active EDM/DIAG2  • Contactor monitoring is inactive EDM/DIAG2  • Ideally aligned SIG LOW/DIAG4  • Weak signal SIG LOW/DIAG4  • Receiver and emitter are synchronized. SIG LOW/DIAG1  • Receiver and emitter are not synchronized. SIG LOW/DIAG1 





































When the maximum range of the sensors is exploited, "SIG LOW/DIAG4" may appear at the display even if they are ideally aligned.

12.3.2 Emitter

Display	Description	Display	Description
<ul style="list-style-type: none"> <input type="radio"/> TEST/DIAG4 <input type="radio"/> DIAG3 <input type="radio"/> DIAG2 <input type="radio"/> HI RAN/DIAG1 <input type="radio"/> ERROR <input checked="" type="radio"/> POWER 	<ul style="list-style-type: none"> • Supply power on • Low range 	<ul style="list-style-type: none"> <input checked="" type="radio"/> TEST/DIAG4 <input type="radio"/> DIAG3 <input type="radio"/> DIAG2 <input type="radio"/> HI RAN/DIAG1 <input type="radio"/> ERROR <input checked="" type="radio"/> POWER 	<ul style="list-style-type: none"> • Supply power on • Low range • Test duration of 150 ms exceeded
<ul style="list-style-type: none"> <input type="radio"/> TEST/DIAG4 <input type="radio"/> DIAG3 <input type="radio"/> DIAG2 <input checked="" type="radio"/> HI RAN/DIAG1 <input type="radio"/> ERROR <input checked="" type="radio"/> POWER 	<ul style="list-style-type: none"> • Supply power on • High range 	<ul style="list-style-type: none"> <input checked="" type="radio"/> TEST/DIAG4 <input type="radio"/> DIAG3 <input type="radio"/> DIAG2 <input checked="" type="radio"/> HI RAN/DIAG1 <input type="radio"/> ERROR <input checked="" type="radio"/> POWER 	<ul style="list-style-type: none"> • Supply power on • High range • Test duration of 150 ms exceeded





























12.4 Display in Case of Error

12.4.1 Receiver

Display	Description	Display	Description
SIG LOW/DIAG4  DIAG3  EDM/DIAG2  SYNC/DIAG1  ERROR  RES  OSSD OFF  OSSD ON 	 <ul style="list-style-type: none"> • OSSD 2 short circuit to plus • Eliminate short circuit to plus. 	SIG LOW/DIAG4  DIAG3  EDM/DIAG2  SYNC/DIAG1  ERROR  RES  OSSD OFF  OSSD ON 	 <ul style="list-style-type: none"> • Contactor is not released. • Contacts are fused together. • Inspect the contactor (connection and function).
SIG LOW/DIAG4  DIAG3  EDM/DIAG2  SYNC/DIAG1  ERROR  RES  OSSD OFF  OSSD ON 	 <ul style="list-style-type: none"> • OSSD 2 short circuit to ground • Eliminate short circuit to ground. 	SIG LOW/DIAG4  DIAG3  EDM/DIAG2  SYNC/DIAG1  ERROR  RES  OSSD OFF  OSSD ON 	 <ul style="list-style-type: none"> • Invalid configuration Restart inhibit detected • For safety mode operation, remove reset button and activate in accordance with section 7.4 on page 46. • For start-up and restart inhibit, connect reset button correctly and activate in accordance with section 7.6 on page 49.
SIG LOW/DIAG4  DIAG3  EDM/DIAG2  SYNC/DIAG1  ERROR  RES  OSSD OFF  OSSD ON 	 <ul style="list-style-type: none"> • Contactor does not pick up. • Inspect the contactor (connection and function). 	SIG LOW/DIAG4  DIAG3  EDM/DIAG2  SYNC/DIAG1  ERROR  RES  OSSD OFF  OSSD ON 	 <ul style="list-style-type: none"> • Invalid configuration, contactor monitoring detected • For contactor monitoring, connect contactor correctly and activate in accordance with section 7.5 on page 47 or section 7.7 on page 51. • Without contactor monitoring: remove contactor and deactivate in accordance with section 7.4 on page 46 or section 7.6 on page 49.

<p>SIG LOW/DIAG4 </p> <p>DIAG3 </p> <p>EDM/DIAG2 </p> <p>SYNC/DIAG1 </p> <p>ERROR </p> <p>RES </p> <p>OSSD OFF </p> <p>OSSD ON </p>	<ul style="list-style-type: none"> • OSSD 1 short circuit to plus  <ul style="list-style-type: none"> • Eliminate short circuit to plus. 	<p>SIG LOW/DIAG4 </p> <p>DIAG3 </p> <p>EDM/DIAG2 </p> <p>SYNC/DIAG1 </p> <p>ERROR </p> <p>RES </p> <p>OSSD OFF </p> <p>OSSD ON </p>	<ul style="list-style-type: none"> • Supply power overvoltage/undervoltage  <ul style="list-style-type: none"> • Provide for supply power within the specified limits.
<p>SIG LOW/DIAG4 </p> <p>DIAG3 </p> <p>EDM/DIAG2 </p> <p>SYNC/DIAG1 </p> <p>ERROR </p> <p>RES </p> <p>OSSD OFF </p> <p>OSSD ON </p>	<ul style="list-style-type: none"> • OSSD 1 short circuit to ground  <ul style="list-style-type: none"> • Eliminate short circuit to ground. 	<p>SIG LOW/DIAG4 </p> <p>DIAG3 </p> <p>EDM/DIAG2 </p> <p>SYNC/DIAG1 </p> <p>ERROR </p> <p>RES </p> <p>OSSD OFF </p> <p>OSSD ON </p>	<ul style="list-style-type: none"> • Internal error  <ul style="list-style-type: none"> • Restart the system. • If restart is not successful, contact wenglor's support department.
<p>SIG LOW/DIAG4 </p> <p>DIAG3 </p> <p>EDM/DIAG2 </p> <p>SYNC/DIAG1 </p> <p>ERROR </p> <p>RES </p> <p>OSSD OFF </p> <p>OSSD ON </p>	<ul style="list-style-type: none"> • Extraneous light/emitter  <ul style="list-style-type: none"> • Remove the interfering emitter. 	<p>SIG LOW/DIAG4 </p> <p>DIAG3 </p> <p>EDM/DIAG2 </p> <p>SYNC/DIAG1 </p> <p>ERROR </p> <p>RES </p> <p>OSSD OFF </p> <p>OSSD ON </p>	<ul style="list-style-type: none"> • Configuration change not completed  <ul style="list-style-type: none"> • Repeat configuration

12.4.2 Emitter

Display	Description	Display	Description
<ul style="list-style-type: none">  TEST/DIAG4  DIAG3  DIAG2  HI RAN/DIAG1  ERROR <ul style="list-style-type: none">  POWER 	<ul style="list-style-type: none"> • Invalid range setting  <ul style="list-style-type: none"> • Set range to high or low. 	<ul style="list-style-type: none">  TEST/DIAG4  DIAG3  DIAG2  HI RAN/DIAG1  ERROR <ul style="list-style-type: none">  POWER 	<ul style="list-style-type: none"> • Invalid range setting • Test duration exceeded  <ul style="list-style-type: none"> • Set range to high or low.
<ul style="list-style-type: none">  TEST/DIAG4  DIAG3  DIAG2  HI RAN/DIAG1  ERROR <ul style="list-style-type: none">  POWER 	<ul style="list-style-type: none"> • Supply power overvoltage/ undervoltage  <ul style="list-style-type: none"> • Provide for supply power within the specified limits. 	<ul style="list-style-type: none">  TEST/DIAG4  DIAG3  DIAG2  HI RAN/DIAG1  ERROR <ul style="list-style-type: none">  POWER 	<ul style="list-style-type: none"> • Parameters configuration for large range without executing the procedure in accordance with 7.3.2  <ul style="list-style-type: none"> • Restart the system. • If restart is not successful, contact wenglor's support department. • Execute procedure in accordance with 7.3.2.

12.5 Initial Start-Up Checklist

This checklist is intended to provide assistance during initial start-up.



NOTE!

The checklist does not eliminate the need for testing before initial start-up or periodic tests conducted by appropriately trained personnel.

1 Standards and Directives, ESPE Selection		
Are the safety precautions based on the directives/standards which are applicable for the machine?	Yes	No
Are the utilized directives and standards listed in the declaration of conformity?	Yes	No
Is the safety device in compliance with the required PL (EN ISO 13849-1)/SILCl (EN 62061) from the risk assessment?	Yes	No
2 Safety Clearance		
Has safety clearance been calculated in accordance with the applicable standards?	Yes	No
Have the response time of the ESPE, the response time of any included safety evaluation unit, and machine over-travel time been taken into account in the calculation?	Yes	No
Has machine over-travel time been measured, specified, documented (at the machine and/or in the machine's documentation) and adapted to the ESPE installation setup?	Yes	No
Is required safety clearance between the point of danger and the safety field adhered to?	Yes	No
3 Access to the Point of Danger		
Is it only possible to access the point of danger via the ESPE's safety field?	Yes	No
Is it assured that persons are unable to remain within the danger zone unprotected (e.g. by means of mechanical protection against side-stepping), and are the implemented measures protected against manipulation?	Yes	No
Have additional mechanical protective measures been installed which prevent reaching under, over or around the safety field, and are they protected against manipulation?	Yes	No
4 Installation		
Have the components of the ESPE been correctly attached and secured against loosening, shifting and rotation after alignment?	Yes	No
Is the external condition of the ESPE and all associated system components flawless?	Yes	No
Has the acknowledgement key for resetting the ESPE been correctly installed outside of the danger zone, and is it functional?	Yes	No

5 Incorporation into the Machine

Have both OSSDs been incorporated into the downstream machine controls?	Yes	No
Have they been connected in accordance with the wiring diagrams?	Yes	No
Are the switching elements which are controlled by the ESPE (e.g. contactors, valves) monitored by EDM?	Yes	No
Have required protective measures against electric shock been effectively implemented?	Yes	No

6 Functionality

Is the ESPE effective during the entire duration of the machine's hazardous motion?.	Yes	No
Is hazardous motion stopped when the ESPE is disconnected from supply power, and does the acknowledgment key have to be activated in order to reset the machine after supply power has been restored?	Yes	No
If a hazardous state has been initialized, is it stopped when the ESPE is switched off, if the operating mode or any of the function types are changed, or if switching to another safety device occurs?	Yes	No
Are the specified safety functions effective in all of the machine's operating modes?	Yes	No
Has the safety function been tested in accordance with the inspection instructions in the operating instructions?	Yes	No
Have the instructions for daily Inspection of the ESPE been attached such that they are plainly visible and legible for operating personnel.	Yes	No

12.6 Connection Examples



NOTE!

Functional earth can be optionally connected.

12.6.1 Restart Inhibit Without Contactor Monitoring at SEMG4xxx

- RES via SEMG
- No EDM
- Low range
- SR4B3B01S

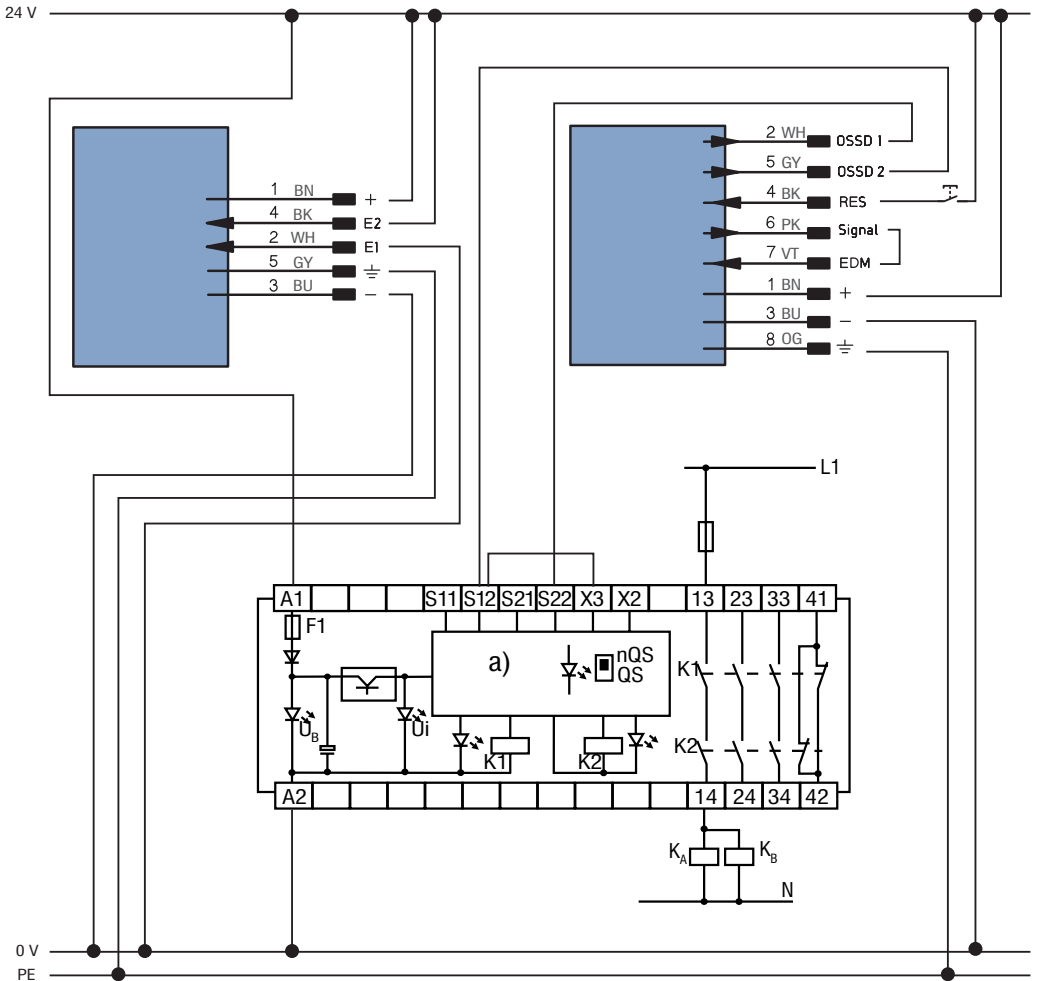

12.6.2 Restart Inhibit and Contactor Monitoring at SEMG4xxx

- RES via SEMG
- EDM via SEMG
- Low range
- SR4B3B01S

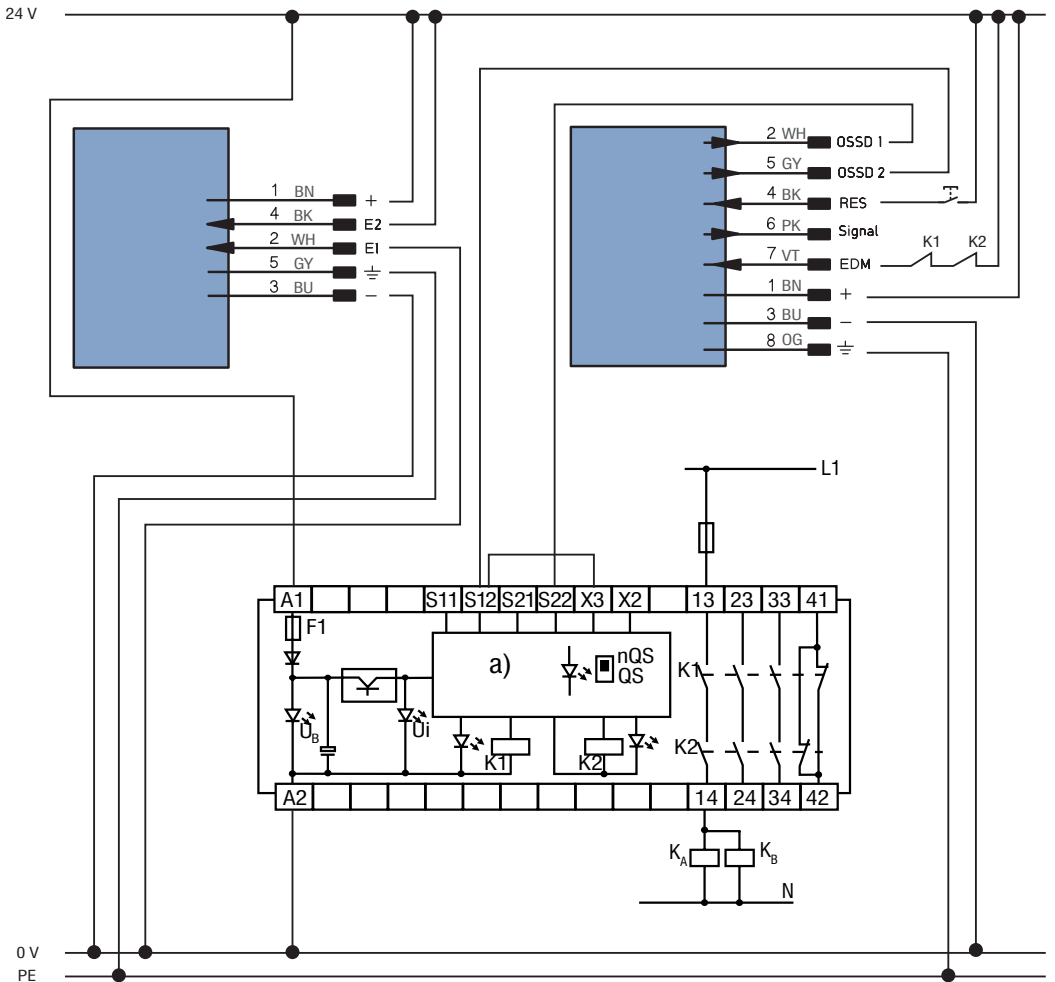

12.6.3 Restart Inhibit Without Contactor Monitoring at Safety Relay

- RES via SR4B3B01S
- No EDM
- High range

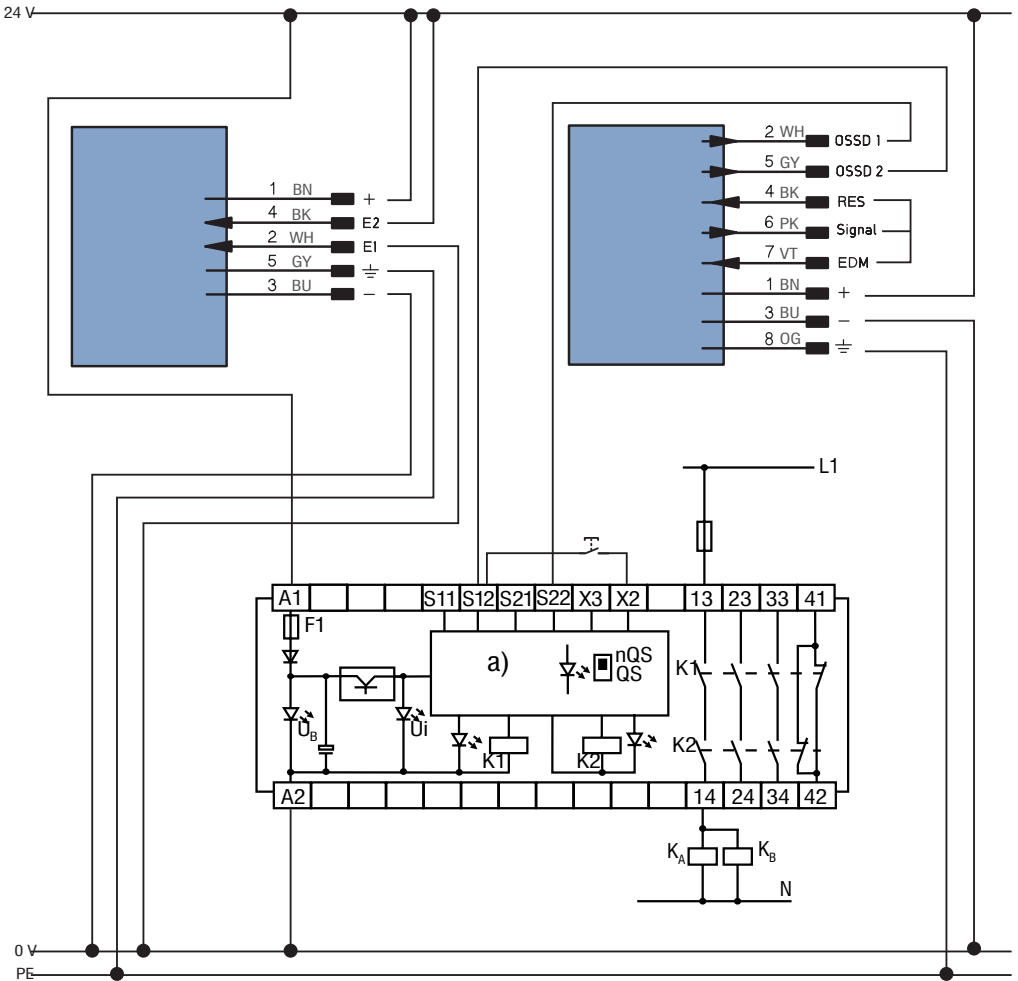

12.6.4 SEMG4xx With Safety Mode Without Contactor Monitoring

- No RES
- No EDM
- Low range

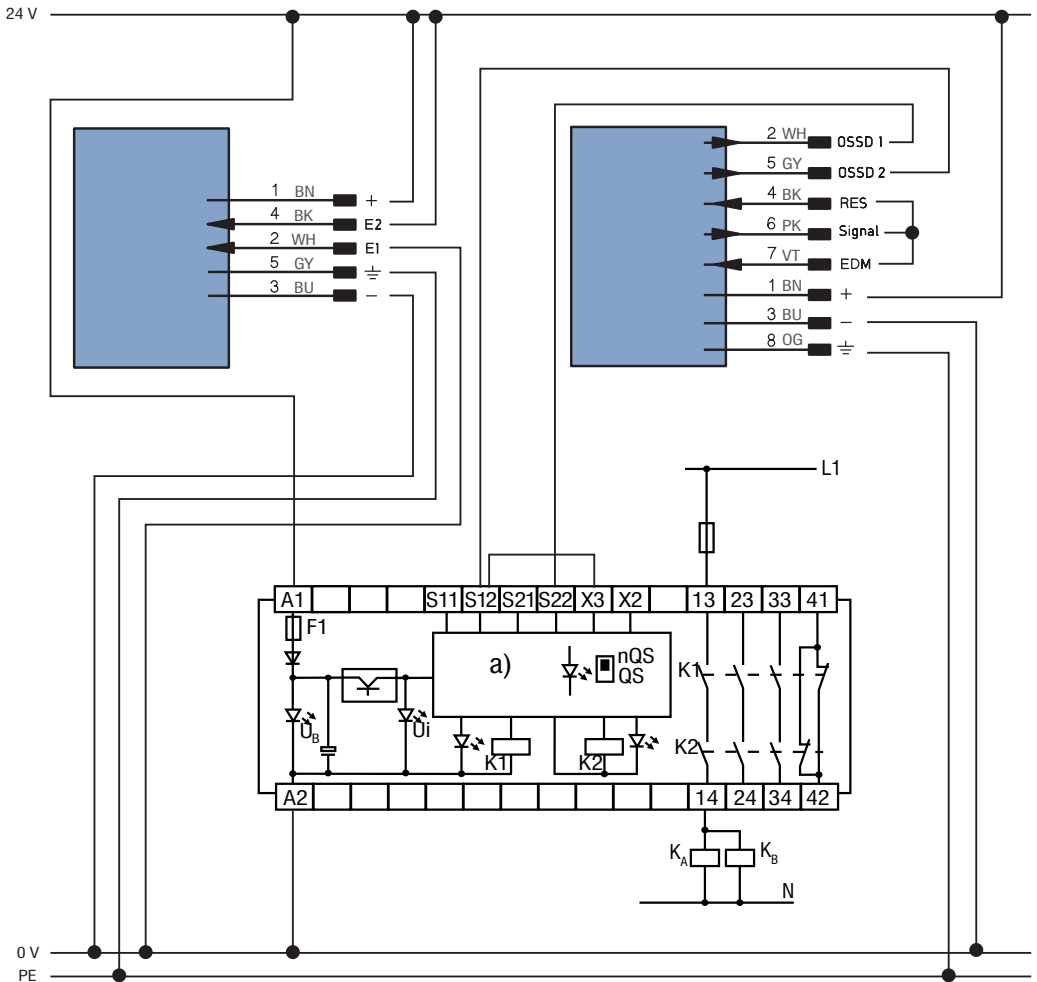

12.7 EU Declaration of Conformity

The EU declaration of conformity can be found on our website at www.wenglor.com in the product's separate download area.

EU Konformitätserklärung EU Declaration of Conformity (DoC)



Name und Anschrift des Herstellers / Name and address of manufacturer:

wenglor sensoric GmbH
wenglor Straße 3
88069 Tettngang / GERMANY

Diese Erklärung gilt für die folgenden Produkte: This declaration applies to the following products:

SEMG4...
SEMG5...
SEMG6...

Wir bestätigen die Übereinstimmung mit den grundlegenden Anforderungen der Europäischen Richtlinien
We confirm compliance with the essential requirements of the European Directives

Richtlinie / Directive	Fundstelle / Reference
EMV / EMC	2014/30/EU Amtsblatt / Official Journal L96 29.03.2014
Maschinen / MD	2006/42/EG Amtsblatt / Official Journal L157 9.06.2006

Folgende harmonisierte Normen wurden angewandt: The following harmonized standards have been used:

EN 61496-1:2013 (Type 4)	EN ISO 13849-1:2015 (Cat. 4, PL e)
IEC 61496-2:2013 (Type 4)	EN 50178:1997
EN 62061:2005 + Cor.:2010 + A1:2013 + A2:2015 (SIL CL 3)	EN 61000-6-4:2007+A1:2011
	EN 61508:2010 (parts 1-3, SIL 3)

Produkt-Beschreibung	Product description
<i>Sicherheits-Lichtvorhang Berührungslos wirkende Schutzeinrichtung Sicherheits-Bauteil nach 2006/42/EG Anhang IV Seriennummer: Lt. Typenschild</i>	<i>Safety Light Curtain Electro-Sensitive Protective Equipment Safety component per 2006/42/EC annex IV Serial Number: See rating plate</i>

Benannte Stelle / Zertifikat Nr. TÜV SÜD Product Service GmbH Ridlerstraße 65 D-80339 München	Notified Body / Certificate Nr. NB Nr. 0123 Z10 040594 036 Rev. 00
---	--

Dr. Alexander Ohl ist bevollmächtigt, die technischen Unterlagen zusammenzustellen.
Dr. Alexander Ohl is authorized to compile the technical documentation.

Diese Erklärung stellvertretend für den Hersteller wird abgegeben durch:
On account of the manufacturer, this declaration is given by:

Dr. Alexander Ohl
Leiter Forschung & Entwicklung / Head of Research & Development

Tettngang, 01.07.2019
Ort / Place Datum / Date

Unterschrift / Signature

