

Model Number

VMA-2+P/Z2-10M-PUR

Valve connector, Form A, 2+PE, Z diode, PUR cable

Features

- Valve connector according EN 175301-803 A/ISO 4400 (previously DIN 43650)
- Z diode as a protective circuit
- Built-in LED, as operating and function indicator
- freely selectable cable models due to bridged protective earth
- Flame resistant cable
- Halogen-free
- UL Recognized Component

Dimensions

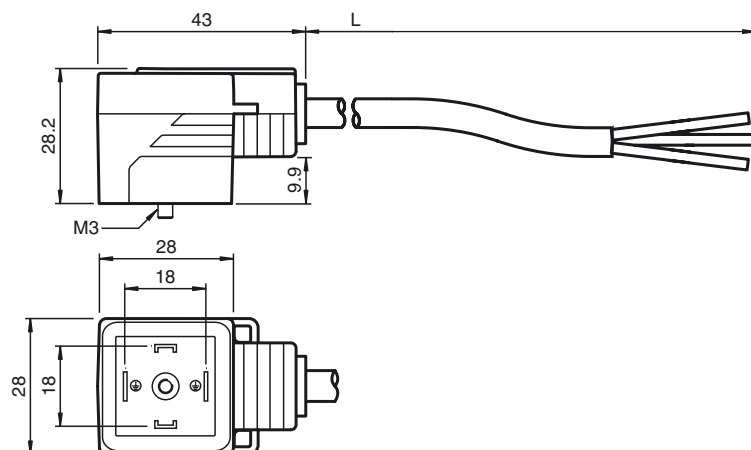

Technical data

General specifications

Number of pins 2 + PE

Indicators/operating means

LED yellow Functional display

Electrical specifications

Operating voltage U_B 24 V AC/DC

Operating current I_B max. 4 A

Volume resistance < 5 m Ω

Suppression Zener diode

Ambient conditions

Ambient temperature Body: -20 ... 85 °C (-4 ... 185 °F)
cable, flexing: -20 ... 80 °C (-4 ... 176 °F)
cable, fixed: -40 ... 80 °C (-40 ... 176 °F)

Pollution degree 3

Mechanical specifications

Degree of protection IP65/IP67

Connection Valve connector Form A

Material

Contacts CuSn

Contact surface Sn

Body TPU, black

Cable PUR

Core insulation PP

Cable

Sheath diameter \varnothing 4.5 mm

Bending radius > 50 mm
> 22.5 mm, fixed

Color dark grey (RAL 7021)

Cores (2 + 1) x 0.5 mm²; 20 AWG

Conductor construction 28 x 0.15 mm \varnothing

Length L 10 m

Approvals and certificates

UL approval cURus AWM 20549 (cable)

Electrical connection

