



Device Manual

SmartPLC DataLine with Profinet device interface

AC1403

AC1404

Master profile: M4

Firmware: 4.3.1 or higher

English

Contents

1	Preliminary note	5
1.1	Legal and copyright information	5
1.2	Purpose of the document	5
1.3	Explanation of Symbols	6
1.4	Overview: User documentation for AC1403/04	7
1.5	Modification history	7
2	Safety instructions	8
2.1	General safety instructions	8
2.2	Required background knowledge	8
2.3	Tampering with the unit	8
3	System description	9
3.1	Intended use	10
3.1.1	Permitted use	10
3.1.2	Prohibited use	10
3.2	Information concerning the device	11
3.2.1	Overview	11
3.2.2	Operating elements	12
3.2.3	Display elements	12
3.2.4	CODESYS SPS	12
3.2.5	Interfaces	13
3.2.6	Required accessories	13
4	Operation	14
4.1	Control of the graphical user interface	14
4.1.1	Function keys	15
4.1.2	Arrow keys	15
4.2	Menu view	16
4.2.1	Menu navigation	16
4.2.2	Navigation aids	17
4.3	Page view	19
4.3.1	Navigate on a page	19
4.3.2	Use navigation aids	19
4.3.3	Description of the control elements	20
4.4	Remote access	32
4.4.1	General	32
4.4.2	Recommended browsers	32
4.4.3	Operating instructions	33
5	Menu	36
5.1	Start screen	36
5.2	Menu functions	37
5.2.1	Additional functions	37
5.3	Quick setup	38
5.3.1	Quick setup: Project AS-i networks	39
5.3.2	Quick setup: Configure the operating mode of the AS-i masters	40
5.3.3	Quick setup: Configure the output access	41
5.3.4	Quick setup: Access the device via QR code	42
5.3.5	Quick setup: Configure the PROFINET interface	42
5.3.6	Quick setup: Set the Konfigurationsschnittstelle 1	43
5.3.7	Quick setup: Set the configuration interface 2	44

5.3.8	Quick setup: Address the AS-i slaves connected to AS-i Master 1	45
5.3.9	Quick setup: Address the AS-i slaves connected to AS-i Master 2	46
5.4	AS-i 1 / AS-i 2	47
5.4.1	AS-i 1 / AS-i 2: Master setup	48
5.4.2	AS-i 1 / AS-i 2: Diagnosis	50
5.4.3	AS-i 1 / AS-i 2: AS-i slaves	52
5.5	System	58
5.5.1	System: Programmable Logic Controller (PLC)	59
5.5.2	System: Information	65
5.5.3	System: Setup	66
5.5.4	System: Diagnosis	79
5.6	Interfaces	80
5.6.1	Interfaces: Konfigurationsschnittstelle 1	81
5.6.2	Interfaces: Configuration interface 2	83
5.6.3	Interfaces: PROFINET interface	84
5.7	ifm system solutions	90
5.7.1	Notes on ifm system solutions	91
5.7.2	Show information about installed ifm apps	92
5.7.3	Install single/basic app	93
5.7.4	Install multi app	94
5.7.5	Update ifm apps	95
5.7.6	Uninstall ifm apps	95
6	Setup	96
6.1	Connect the device to the periphery	96
6.1.1	EtherNet/IP interface	96
6.1.2	Configuration interface	96
6.2	zzStart screen 'Basic settings'	97
6.2.1	Change the basic settings of the device	97
6.3	Update the firmware of the device	99
6.3.1	Behaviour of the settings upon firmware update	99
6.3.2	Firmware update from SD card	100
6.3.3	Firmware update via the web interface	101
6.4	Connect and address AS-i slaves	103
6.5	Set up Profinet	103
6.6	Set Ethernet configuration interfaces	104
6.7	Exchange AS-i slave	104
7	Troubleshooting	105
7.1	Status LED	105
7.1.1	Status LED: Basic device	105
7.1.2	Status LED: Fieldbus PROFINET	105
7.2	Start screen: Status LEDs	106
7.2.1	Status of the web interface	106
7.2.2	Operating mode of the AS-i master	106
7.2.3	Control instance of the AS-i outputs	106
7.2.4	Fieldbus status	106
7.3	Online diagnosis function	107
7.3.1	Message types	107
7.3.2	Locate error sources	107
7.4	Online Support Center (OSC)	108
7.4.1	OSC: View current error messages	109
7.4.2	OSC: Show message history	110
8	Appendix	111
8.1	Approval tests / certifications	111
8.2	Technical data	112
8.2.1	Housing	112
8.2.2	Power supply connections	112

8.2.3	Operation.....	112
8.2.4	Display elements	112
8.2.5	Interfaces.....	113
8.2.6	Programmable Logic Controller (PLC)	113
8.3	Address assignment in Ethernet networks	114
8.4	Configuration interfaces: Connection concepts	115
8.4.1	Direct connection.....	115
8.4.2	Connection via Ethernet network.....	116
8.5	AS-i master	117
8.5.1	Operating modes of the AS-i master	118
8.5.2	Master flags.....	120
8.6	AS-i slaves	121
8.6.1	Profiles of AS-i slaves.....	122
8.7	Fieldbus Profinet	131
8.7.1	Fieldbus parameters.....	131
8.7.2	Parameter data.....	132
8.7.3	Cyclic data	135
8.7.4	Acyclic data	151
8.7.5	I&M data	157
8.7.6	Fieldbus alarms	159
8.8	OSC messages	170
8.8.1	OSC messages: System	170
8.8.2	OSC messages: AS-i 1 / AS-i 2	171

1 Preliminary note

Content

Legal and copyright information	5
Purpose of the document	5
Explanation of Symbols	6
Overview: User documentation for AC1403/04	7
Modification history	7

33203

1.1 Legal and copyright information

33117

© All rights reserved by ifm electronic gmbh. No part of this manual may be reproduced and used without the consent of ifm electronic gmbh.

All product names, pictures, companies or other brands used on our pages are the property of the respective rights owners:

- AS-i is the property of the AS-International Association, (→ www.as-interface.net)
- CAN is the property of the CiA (CAN in Automation e.V.), Germany (→ www.can-cia.org)
- CODESYS™ is the property of the 3S – Smart Software Solutions GmbH, Germany (→ www.codesys.com)
- DeviceNet™ is the property of the ODVA™ (Open DeviceNet Vendor Association), USA (→ www.odva.org)
- EtherNet/IP® is the property of the → ODVA™
- EtherCAT® is a registered trade mark and patented technology, licensed by Beckhoff Automation GmbH, Germany
- IO-Link® (→ www.io-link.com) is the property of the → PROFIBUS Nutzerorganisation e.V., Germany
- ISOBUS is the property of the AEF – Agricultural Industry Electronics Foundation e.V., Deutschland (→ www.aef-online.org)
- Microsoft® is the property of the Microsoft Corporation, USA (→ www.microsoft.com)
- PROFIBUS® is the property of the PROFIBUS Nutzerorganisation e.V., Germany (→ www.profibus.com)
- PROFINET® is the property of the → PROFIBUS Nutzerorganisation e.V., Germany
- Windows® is the property of the → Microsoft Corporation, USA

1.2 Purpose of the document

41760

This document applies to devices of the type "SmartSPS DataLine mit Profinet-Device-Schnittstelle (art. no.: AC1403/04)

It is part of the device and contains information about the correct handling of the product.

- ▶ Read this document before using the device.
- ▶ Keep this document during the service life of the device.

1.3 Explanation of Symbols

34171



WARNING!

Death or serious irreversible injuries may result.



CAUTION!

Slight reversible injuries may result.

NOTICE!

Property damage is to be expected or may result.



Important note

Non-compliance can result in malfunction or interference



Information

Supplementary note



Request for action



Reaction, result



"see"

abc

Cross-reference

123

Decimal number

0x123

Hexadecimal number

0b010

Binary number

[...]

Designation of pushbuttons, buttons or indications

1.4 Overview: User documentation for AC1403/04

41793

ifm electronic provides the following user documentation for the models of the device class "SmartSPS DataLine mit Profinet-Device-Schnittstelle":

Document	Content / Description
Data sheet	Technical data of the device as a table
Operating instructions *	<ul style="list-style-type: none"> ▪ Notes on mounting and electrical installation of the device ▪ Set-up, description of the operating and display elements, maintenance information, scale drawing
Device manual	<ul style="list-style-type: none"> ▪ Notes on operation of the device via GUI and web interface ▪ Error elimination ▪ Description of the fieldbus data
Supplement device manual	<ul style="list-style-type: none"> ▪ Description of the acyclic data sets and the command interface
Programming manual	<ul style="list-style-type: none"> ▪ Creation of a project with the device using CODESYS ▪ Configuration of the device using CODESYS ▪ Programming of the SPS of the device ▪ Description of the device-specific CODESYS function libraries

*... The operating instructions are supplied with the device.



The user can download all documents from the ifm website.

1.5 Modification history

34492

Version	Topic	Date
00	New creation of document	12 / 2017
01	<ul style="list-style-type: none"> ▪ Update to Firmware 4.3.1 ▪ Changed: Restore device configuration 	09 / 2018

2 Safety instructions

Content

General safety instructions	8
Required background knowledge	8
Tampering with the unit	8

28333

2.1 General safety instructions

41415

Read this document before setting up the product and keep it during the entire service life.

Only use the product for its intended purpose.

If the operating instructions or the technical data are not adhered to, personal injury and/or damage to property may occur.

Improper or non-intended use may lead to malfunctions of the device, to unwanted effects in the application or to a loss of the warranty claims.

The manufacturer assumes no liability for any consequences caused by tampering with the device or incorrect use by the operator.

- ▶ Observe these operating instructions.
- ▶ Adhere to the warning notes on the product.

2.2 Required background knowledge

41648

This document is intended for specialists. Specialists are people who, based on their relevant training and experience, are capable of identifying risks and avoiding potential hazards that may be caused during operation or maintenance of the product.

For programming these people should also have knowledge of control technology experience in PLC programming to IEC 61131-3.

The document contains information about the correct handling of the product.

2.3 Tampering with the unit

33190



WARNING!

Tampering with the unit.

- > In case of non-compliance:
 - Possible affects on safety of operators and machinery
 - Expiration of liability and warranty
- ▶ Do not open the devices!
- ▶ Do not insert any objects into the devices!
- ▶ Prevent metal foreign bodies from penetrating!

3 System description

Content

Intended use	10
Information concerning the device	11

28392

3.1 Intended use

Content

Permitted use	10
Prohibited use.....	10

36928

3.1.1 Permitted use

36762

The device is designed for operation in the control cabinet.

The device may only be used for the following purposes:

- as AS-i master in 1 or 2 AS-i networks to control the data exchange to the sensor/actuator level
- as gateway between the AS-i network and a higher-level controller (PROFINET-Controller = Host; e.g. PLC) via the fieldbus interface
- as Programmable Logic Controller (PLC) for program-based parameter setting, control and regulation of the AS-i slaves connected to the device
- as EtherCAT master (software extension)
- as fieldbus slave (software extension)

3.1.2 Prohibited use

34228

The device may not be used beyond the limits of the technical data (→ **Technical data** (→ S. [112](#)))!

3.2 Information concerning the device

Content

Overview.....	11
Operating elements.....	12
Display elements.....	12
CODESYS SPS.....	12
Interfaces.....	13
Required accessories.....	13

36905

3.2.1 Overview

36757

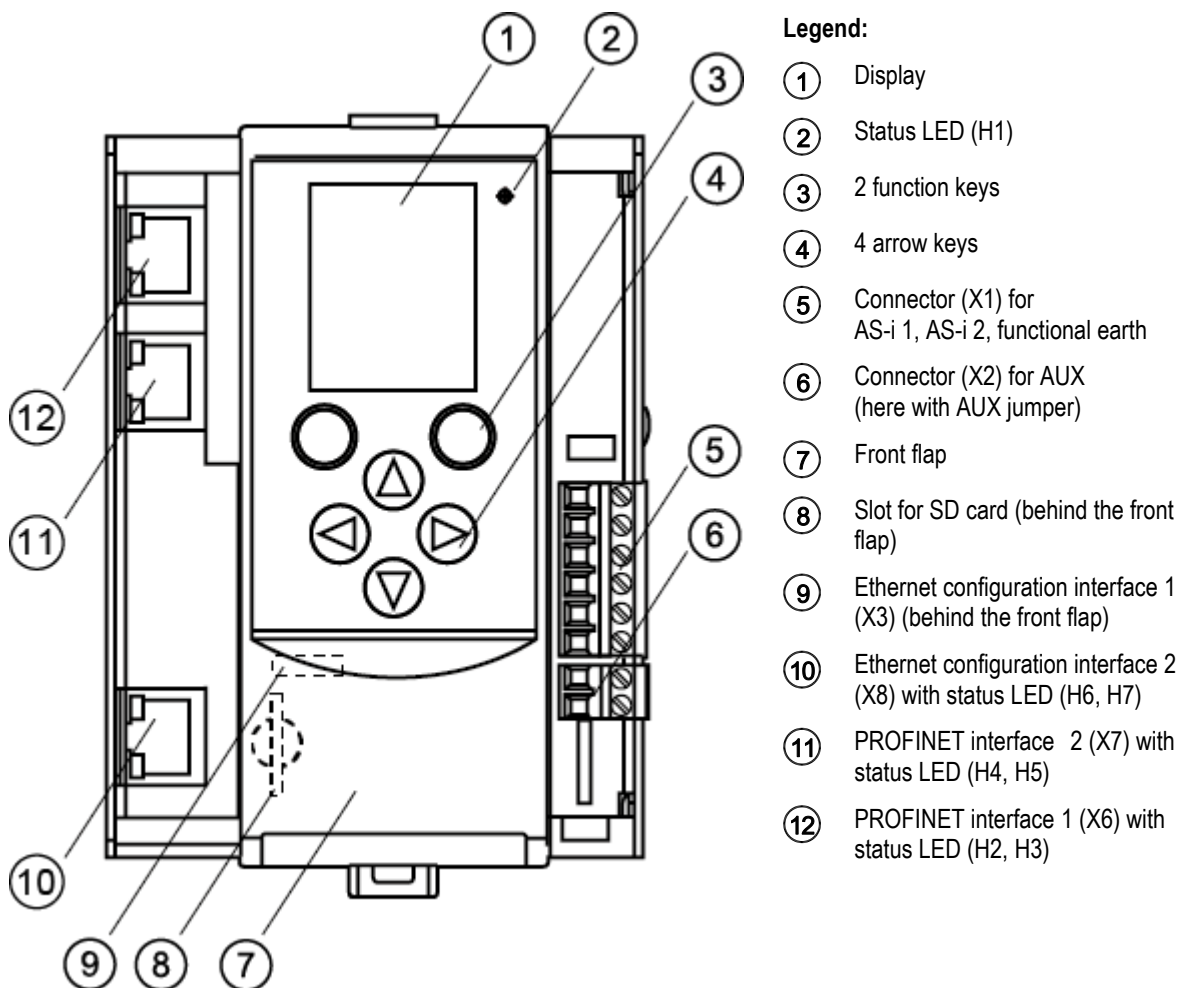

3.2.2 Operating elements

36790

The device provides the following operating elements.

Arrow and function keys

36959

Below the display is the key panel with two function keys and four arrow keys. The operator controls the Graphical User Interface (GUI) of the device with the keys.

Operating notes: → **Operation** (→ S. [14](#))

3.2.3 Display elements

36917

The device provides the following display elements:

Display

36894

The display is used to display the Graphical User Interface (GUI) of the device.

Operating notes: → **Operation** (→ S. [14](#))

Technical data: → **Technical data** (→ S. [112](#))

Status LEDs

36784

The device features the following status LEDs which display the current status of system components. Meaning of the LED colours and flashing frequencies: → **Status LED** (→ S. [105](#))

3.2.4 CODESYS SPS

36953

The device features a Programmable Logic Controller (PLC). The PLC can run the following application types:

- Applications that have been created with the IEC 61131-3 compliant programming software "CODESYS Development System" (from version V3.5 SP9 Patch 7 Hotfix 3)
- System solutions that have been provided by ifm electronic

Technical data: → **Programmable Logic Controller (PLC)** (→ S. [113](#))



For information about the programming of the device-internal SPS with CODESYS, please refer to the programming manual:

→ www.ifm.com > product page > [Downloads]

3.2.5 Interfaces

36927

The device provides the following interfaces:

Ethernet configuration interfaces

36913

The configuration interface 1 (X3) is behind the front flap of the device.

The configuration interface 2 (X8) is underneath the PROFINET interface (X6/X7).

The user can access the following functions via both interfaces:

- web interface for device configuration and diagnostics
- Programming of the device-internal SPS and the fail-safe PLC with CODESYS
- Operation as additional fieldbus interface

Possible network topologies: → **Configuration interfaces: Connection concepts** (→ S. [115](#))

Technical data: → **Technical data** (→ S. [112](#))

PROFINET fieldbus interface

36925

The device communicates with the higher-level control instance of the PROFINET network via the PROFINET interface (X6/X7).

- Notes regarding connection concepts: → **Configuration interfaces: Connection concepts** (→ S. [115](#))
- Technical data: → **Technical data** (→ S. [112](#))

SD card slot

36761

The SD card slot (X5) is located behind the front flap of the device. The following actions can be performed with an SD card:

- update the firmware of the device
- save/restore the device configuration

Technical data: → **Technical data** (→ S. [112](#))

3.2.6 Required accessories

36764

To be able to operate the device in a sensible way you need the following accessories (not supplied with the device):

- Depending on the selected voltage supply (→ Operating instructions) you need:
 - a power supply for the 24 V power supply (e.g. art. no. DN3011)
 - for each AS-i master one AS-i power supply each (e.g. art. no. AC1236)
 - a data decoupling module AC1250 (accessory, optional)
- AS-i slaves.

4 Operation

Content

Control of the graphical user interface	14
Menu view.....	16
Page view	19
Remote access.....	32

41713

4.1 Control of the graphical user interface

41568

Below the display is the key panel with six membrane keys. The operator controls the graphical user interface of the device with these keys. The key panel is closely linked to the navigation status bar.

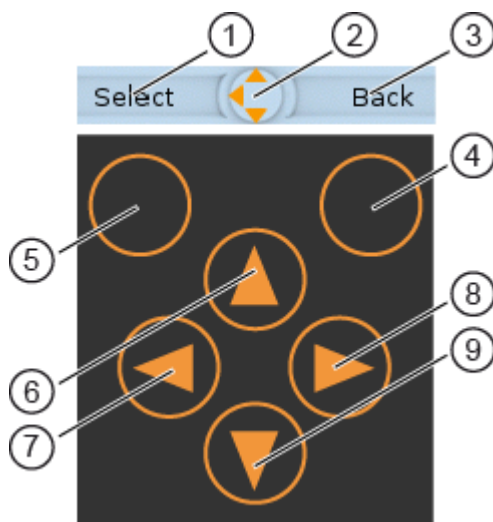

Legend:

- ① Label left function key
- ② Navigation compass
- ③ Label right function key
- ④ Right function key
- ⑤ Left function key
- ⑥ [▲] arrow key
- ⑦ [◀] arrow key
- ⑧ [▶] arrow key
- ⑨ [▼] arrow key

4.1.1 Function keys

41476

The two **function keys** allow the operator to trigger specified actions (e.g. tick a checkbox). The function of the function keys changes depending on the context.

The two **text fields in the navigation status bar** are associated with the function keys located directly below the display. They indicate the action that will be triggered if the function key is pressed in the current work step. If the function key is not labelled, it means that it has no function in the present situation.

Example (→ figure):

- ▶ The left function key triggers the action [Select].
- ▶ The right function key triggers the action [Back].

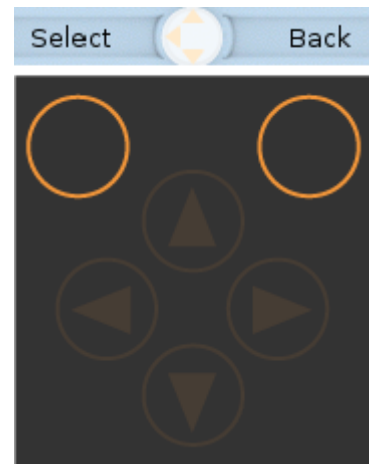

4.1.2 Arrow keys

7091

The four **arrow keys** [▲], [▶], [▼] and [◀] can be used for navigation and selection.

The **navigation compass** shows which of the four arrow keys can be used in the respective work step.

Examples:



All arrow keys are active and will trigger a device response when pressed.



Only the arrow keys [▶] and [▼] are active and will trigger a device response when pressed.

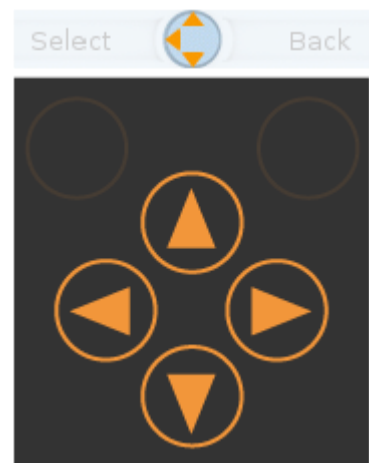

4.2 Menu view

The menu view allows the user to select the menu page with the required control or display function.

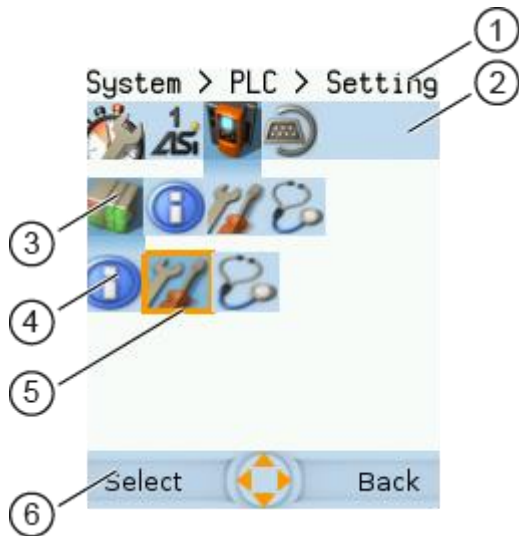

Legend:

- ① Info bar
- ② Main navigation bar
- ③ Subnavigation bar 1
- ④ Subnavigation bar 2
- ⑤ Selected menu item (focus)
- ⑥ Navigation status bar with
 - labelling of the function keys
 - navigation compass



Long texts are displayed as scrolling text in the info bar.

4.2.1 Menu navigation

The central operating elements in the menu view are the three **navigation bars**. They reflect the menu structure of the device software. Each navigation bar represents a menu level. The symbols in a navigation bar represent the submenus and menu items.

Rules for menu navigation:

- ▶ Use [◀] / [▶] to navigate within a menu level.
- > The selected symbol has the **focus** (= orange frame).
- > If the selected symbol has a submenu, the corresponding **subnavigation bar** will automatically appear.
- ▶ Use [▼] to go one menu level down.
- ▶ Use [▲] to go one menu level up.

At th

e lowest menu level:

- ▶ Press [Select] function key to go to the page of the selected menu item (→ **Page view** (→ S. [19](#))).

In the main navigation bar:

- ▶ Press [Back] function key to return to the start screen (→ **Start screen** (→ S. [36](#))).

4.2.2 Navigation aids

41748

The following screen elements help you navigate through the menu:

- > The **info bar** shows the navigation path of the selected menu symbol.
- > The **navigation compass** shows which navigation steps are possible from the current position.

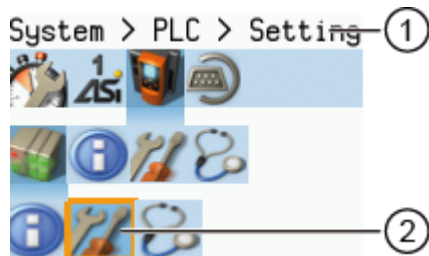

Legend:

- ① Info bar

Navigation path to the focused menu element:
[System] > [PLC] > [Setup]

- ② Menu element with focus

Navigation path to the focused menu element:



Example

41499

To access the menu page containing the setting options for the device-internal PLC:

1. > Initial position when accessing the menu screen
2. ► Use [▶] to select the [System] menu symbol.
 - > The focus is on the [System] menu symbol.
 - > The first subnavigation bar appears.
3. ► Use [▼] to change to the first subnavigation barh.
 - > The focus is on the [Diagnosis] menu symbol.
4. ► Use [◀] to select the [PLC] menu symbol.
 - > The focus is on the [PLC] menu symbol.
 - > The second subnavigation bar appears.
5. ► Use [▼] to change to the second subnavigation bar.
 - > The focus is on the [Information] menu symbol.



6.
 - ▶ Use [▶] to select the [Settings] menu symbol.
 - > The focus is on the [Settings] menu symbol.
 - ▶ Press the [Select] function key to go to the page view of the [Settings] menu item.
 - > The page shows the setting options for the device-internal PLC.

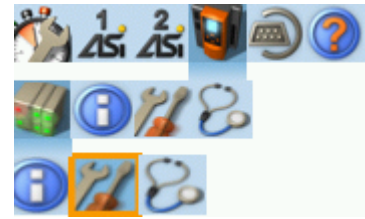

4.3 Page view

41786

The page view allows the user to select and execute a requested function.

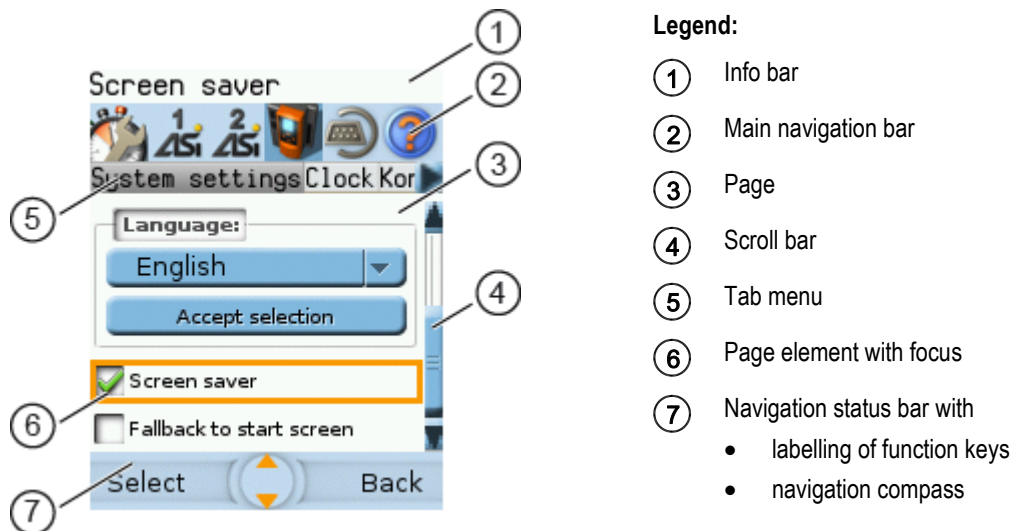

Legend:

- ① Info bar
- ② Main navigation bar
- ③ Page
- ④ Scroll bar
- ⑤ Tab menu
- ⑥ Page element with focus
- ⑦ Navigation status bar with
 - labelling of function keys
 - navigation compass

4.3.1 Navigate on a page

41749

The page contains elements, that allow the operator to control the device or access information.

For page navigation, the following basic rules apply:

- ▶ Use the arrow keys [▼] / [▲] to change between the different page elements.
- > The selected element is marked (= orange frame).
- ▶ Use the [Back] function key to return to the tab menu / menu view.



Rules for using the different control elements: → **Description of the control elements** (→ S. [20](#))

4.3.2 Use navigation aids

41678

The following aids offer navigation users additional orientation:

- > The **info bar** shows detailed information about the selected element (focus).



Long texts are displayed as scrolling text in the info bar.

- > The active menu symbol in the **main navigation bar** has a dark background.
- > A **scroll bar** appears on the right side of the screen if the elements do not fit on the page.
- > The **navigation compass** shows the navigation options in the active work step.
- > The **text fields in the navigation status bar** show the current assignment of the function keys.

4.3.3 Description of the control elements

Content	
Tab menu/Tab	21
Button	22
Checkbox.....	22
List	23
Slave selector	24
Confirmation message.....	29
Numerical field	30
Binary field	31

41586

A page consists of different control elements.

Tab menu/Tab

A tab menu groups together the different functions of a menu page. A tab menu consists of at least two tabs. A tab combines related functions.

Example:

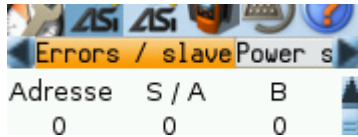

- > The focused tab has an orange background
- > The info bar displays the name of the active tab (in this example: Errors / slave).
- > The symbols ◀ and ▶ indicate that there are more tabs on the left and right sides of the visible tab.
- > The page shows the control elements that belong to the currently selected tab.

Tabs can have the following background colours:

Version = Tab has the focus

Version = Tab is active

Version = Tab is inactive

Use:

1 Select the menu item

- ▶ Go to the menu item with the tab menu.
- > The tab menu appears.
- > The focus is on the left-hand tab.

2 Select a tab

- ▶ Use [◀] / [▶] arrow key to select the desired tab.
- > The focus (orange background) moves to the selected tab:

Version
- > The page shows the functions of the selected tab.

3 Activate the menu page

- ▶ Press [Select] arrow key to go to the page that belongs to the active tab.
- > When going to the page, the tab menu remains visible.
- > The background colour of the active tab turns grey.

Version

4 Carry out the desired functions

- ▶ Use [▼] to select and execute the desired function.

5 Change to tab menu

- ▶ Press [Back] function key to change to the tab menu.
- > The focus (orange background) moves to the active tab.

Button

41536

A button allows the operator to carry out a specified action once. The caption on the button describes the action.

Example:



Use:

1 Select a button

- ▶ Use the arrow keys [▲] / [▼] to select a button.
- > The selected button gets an orange frame:

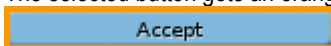

2 Activate the button

- ▶ Use [Select] function key to activate the selected button.
- > The function is executed.

Checkbox

41600

A checkbox permits the user to activate/deactivate a parameter. A checkbox control element consists of a checkbox and a caption.

Example:

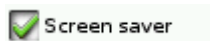

Use:

1 Select a checkbox

- ▶ Use [▲] / [▼] arrow key to select the checkbox
- > The focus (orange frame) moves to the selected checkbox

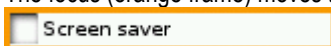

OR:



2 Check/uncheck a checkbox

- ▶ Use [Select] function key to check/uncheck the selected checkbox.
- > The status change is indicated:
 - ☑ = checkbox is checked
 - OR:
 - ☐ = checkbox is unchecked



The setting or clearing of a checkbox is not always immediately effective. Often the change must be confirmed by clicking a button (e.g. [\[Accept selection\]](#))!

List

A list provides a set of defined values. The operator can select precisely one value from this set (= 1 of n selection).

Examples:

 = list without caption

Filter:  = list with caption

Use:

1 Select a list

- ▶ Use [▲] / [▼] arrow key to select the list.
- > The focus (orange frame) moves to the selected list.

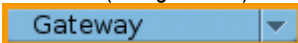

- > The list shows the active value: (in this example Gateway).

2 Activate the list

- ▶ Use [Select] function key to open the list.
- > The opened list shows the selectable values.

3 Select a value

- ▶ Use [▲] / [▼] arrow key to select the desired value from the list.
- > The background colour of the selected value turns orange.

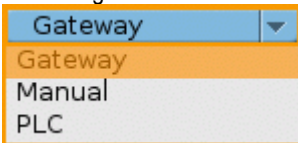

4 Apply the selected value

- ▶ Use [Select] function key to apply the selected value.
OR:
Use [Back] function key to quit and close the list.
- > The list shows the selected value.



The set value will not always become effective immediately. Often the change must be confirmed by clicking a button (e.g. [\[Accept selection\]](#))!

Slave selector

Content

Overview of slave states.....	25
Overview of free slave addresses	27

41653

The slave selector is used to select an AS-i slave or an AS-i address.

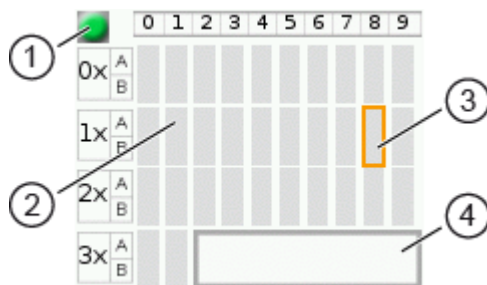

Legend:

- ① Indicator of AS-i master operating mode
- ② AS-i address symbol
- ③ Highlighted AS-i address (focus)
- ④ Status message of highlighted AS-i address

- > The **status LED** indicates the active operating mode of the AS-i master:
 - = AS-i master in protected mode
 - = AS-i master in projection mode
- > Every field represents an **AS-i address**. An AS-i address can be occupied by:
 - a single slave symbol
 - an A/B slave pair symbol
- > The row and column headers help to locate the AS-i address.

Example: address of the field selected in the picture

- row header: 1x (= tens digit of the AS-i address)
- column header: 8 (= units digit of the AS-i address)
- type of slave: single slave (= symbol fully occupies the address field)
- resulting AS-i address: 18

- > The symbol of the A/B slave pair appears when an A or B slave is used on this address.

The slave selector is used in the following overviews:

- Overview of slave states (→ **Overview of slave states** (→ S. [25](#)))
- Overview of free slave addresses (→ **Overview of free slave addresses** (→ S. [27](#)))

Overview of slave states

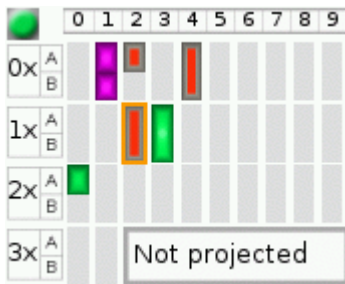

- > The slave selector shows an overview of the slaves in the selected AS-i network.
- > The symbol colour signals the slave status. Meaning of symbols and colours:
→ **Slave status: colour code + symbols** (→ S. 26)
- > The text field displays the status of the selected AS-i slave.
Possible status messages:
 - Slave active
 - Not projected (= configuration error)
 - Double address (= double address error)
 - Periphery (= periphery fault)

Use:

1 Select an AS-i slave













- ▶ Use the arrow keys [▲], [▶], [▼] and [◀] to select the desired AS-i slave.
- > The focus (= orange frame) is on the selected AS-i slave.
- > The info bar shows the address of the selected AS-i slave.
- > The text field shows a status message about the selected AS-i slave.

2 Activate the selected AS-i slave

- ▶ Use [Select] function key to activate the selected AS-i slave and go to the next menu page.
OR:
Use [Back] function key to cancel and leave the slave selector.



Slave status: colour code + symbols

41652

Single slave	A/B slave	Colour	Meaning
		grey	No slave found: slave address is neither in the LPS nor in the LDS
		green	Slave is activated (in LAS)
		red	Configuration error type 1: slave is projected (in LPS) but was not found (in LDS)
		yellow	Slave signals a peripheral fault
		pink	Several slaves have the same address (double address error)
		grey red	Configuration error type 2: <ul style="list-style-type: none"> ▪ the found slave (in LDS) is not projected (in LPS) ▪ the found slave has another profile than projected

Meaning of the colour combinations (example: configuration error type 2)

41741

Symbol	Colour	Meaning
	grey red grey	Configuration error type 2: <ul style="list-style-type: none"> ▪ Single slave is projected (in LPS) but was not found (in LDS). ▪ Instead, a new A slave with the same address was installed.
	grey grey red	Configuration error type 2: <ul style="list-style-type: none"> ▪ Single slave is projected (in LPS) but was not found (in LDS). ▪ Instead, a new B slave with the same address was installed.
	grey red	Configuration error type 2: <ul style="list-style-type: none"> ▪ A or B slave is projected (in LPS) but was not found (in LDS). ▪ Instead, a new single slave with the same address was installed.

Overview of free slave addresses

In this overview, the slave selector shows the free and occupied AS-i addresses.



- > The symbol colour indicates the state of the AS-i address.
Meaning of symbols and colours:
→ **Free slave addresses: colour code + symbols** (→ S. 28)
- > The text field displays the status of the selected AS-i slave.
Possible status messages:
 - Free
 - Missing slave

Use:

1 Select the AS-i address







- ▶ Use the arrow keys [▲], [▶], [▼] and [◀] to select the desired AS-i address.
 - > The focus (= orange frame) is on the selected AS-i address.
 - > The info bar displays the selected AS-i address.
 - > The text field shows a status message for the selected AS-i address.

2 Activate the selected AS-i address

- ▶ Press [Select] function key to activate the selected AS-i address and go to the next menu page.
OR:
Press [Back] function key to cancel and leave the slave selector.









Free slave addresses: colour code + symbols

41493

Single slave	A/B slave	Colour	Meaning	Prio.
		grey	Slave address is already used.	--
		turquoise	Address is free according to LDS (= no slave found), however: address already belongs to a stored projection (= application profile).	1
		blue	Address is free according to LDS (= no slave found). Address is not used in a stored projection (= application profile).	2

Meaning of the colour combinations

41736

Symbol	Colour	Meaning
	blue blue	Slave to be addressed is an A/B slave: A and B addresses are free.
	blue grey	Slave to be addressed is an A/B slave: – A address is free. – B address is used.
	grey blue	Slave to be addressed is an A/B slave: – A address is used. – B address is free.
	turquoise turquoise	Slave to be addressed is an A/B slave: A and B addresses are free, but already used in a stored projection.
	turquoise grey	Slave to be addressed is an A/B slave: – A address is free, but already used in a stored projection. – B address is used.
	grey turquoise	Slave to be addressed is an A/B slave: – A address is used. – B address is free, but already used in a stored projection.
	turquoise blue	Slave to be addressed is an A/B slave: – A address is free, but already used in a stored projection. – B address is free.
	blue turquoise	Slave to be addressed is an A/B slave: – A address is free – B address is free, but already used in a stored projection.

Confirmation message

The confirmation message is a security prompt. It appears when important changes are made to the system settings. The confirmation message shows the changes made. For the changes to become effective, they first need to be acknowledged by the operator.

Example:



- > Action: Change AS-i slave address from 1a to 1b
- > Confirmation message shows:
 - Action (= Change AS-i address)
 - Slave address prior to change
 - Slave address after change
- > The operator has the following input options:
 - [Select] function key
 - [Back] function key

Use:

1 Change the settings



- ▶ Change the system settings.
- > The confirmation message appears.

2 Confirm the message

- ▶ Press [Select] function key to confirm the changes and apply the new value.
OR:
Press [Back] function key to reject the changes and continue to use the old value.
- > The page displays the valid settings.

Numerical field

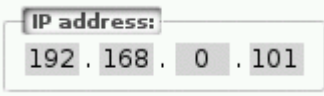
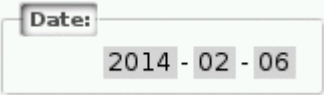
The numerical field allows the operator to enter integer values. The value range is context-specific. Numerical fields are part of the following GUI elements:

Control element	Example	Meaning
IP address		Entry of an IP address (IPv4) in [w.x.y.z] format <ul style="list-style-type: none"> w x y z = network segments (value range: 0... 255)
Date		Date entry in [yyyy-mm-ss] format <ul style="list-style-type: none"> yyyy = year (value range: 0000 ... 9999) mm = month (value range: 01 ... 12) dd = day (value range: 01 ... 31)
Time		Time entry in [hh:mm:ss] format <ul style="list-style-type: none"> hh = hours (value range: 00 ... 12) mm = minutes (value range: 00 ... 59) ss = seconds (value range: 00 ... 59) <p>! The numerical field for seconds (ss) cannot be edited!</p>
Analogue value		Entry of an analogue output value Value range (per numerical field): 0 ... 9

Use (using the example of the numerical date field):

1 Select a numerical field

- ▶ Use [▲]/[▼] arrow key to select the date control element.
- > The focus (= orange frame) is on the selected date control element.



- > The date control element displays the current date

2 Activate the editing mode

- ▶ Press [Select] function key to enter the editing mode.
- > The focus (orange frame) is on the right element



3 Set the desired value

- ▶ Use [▲]/[▼] arrow key to increment the desired value.
- > The segment displays the new value.



Press and hold the arrow key [▲]/[▼] to rapidly move through larger value ranges.

4 Select the next segment

- ▶ Use the arrow key [◀]/[▶] to mark the segment to be edited.
- > The focus (orange frame) moves to the marked segment



- ▶ Optional: Repeat steps 3 and 4 until all segments have the desired values.

5 Adopt the set values

- ▶ Use [Select] function key to confirm the set values and to leave the edit mode.
OR:
Use [Back] function key to reset the set values and to leave the edit mode.
- > The date control element displays the valid date



The set value will not always become effective immediately. Often the change must be confirmed by clicking a button (e.g. [\[Accept selection\]](#))!



Binary field

41531

The binary field allows the operator to change a digital value bit-wise.

Example:



- > Display of the 4-bit digital value:
 - Binary representation
 -  = bit is on (= 1).
 -  = bit is off (= 0).
 - Hexadecimal representation:
0xf = 1111

Use:

1 Select the binary field

- ▶ Use [▲] / [▼] arrow key to select the binary field.
- > The focus (orange frame) is on the selected binary field.



- > The control element shows the current value (digital and hexadecimal).

2 Activate the editing mode

- ▶ Press [Select] function key to enter the editing mode.
- > The focus (orange frame) is on the right element.



3 Set the desired value

- ▶ Use [▲] / [▼] arrow key to set the desired value.
- > The control element shows the new value in digital and hexadecimal format.

4 Select the next segment

- ▶ Use [◀] / [▶] arrow key to mark the segment to be edited.
- > The focus (orange frame) is on the selected segment.



- ▶ Optional: Repeat steps 3 and 4 until all segments have the desired values.

5 Apply the set values

- ▶ Use [Select] function key to confirm the set values and to leave the edit mode.
OR:
Use [Back] function key to reset the set values and to leave the edit mode.
- > The binary field displays the current value (binary and hexadecimal).

4.4 Remote access

Content

General.....	32
Recommended browsers.....	32
Operating instructions.....	33

41775

The device has an integrated web server. It generates a web interface which allows remote access to all device functions via an web browser. The web-interface allows the operator to easily configure, parameterise and monitor the device in permanent operation via an ethernet-based network.

4.4.1 General

41475

The operating concept of the web interface follows the same philosophy as the operating concept of the local display. The web interface uses the same menu items, the same menu structure and the same symbols as the graphic user interface of the local display.



Observe notes regarding the additional functionality of the web interface: → **Additional functions** (→ S. [37](#))

4.4.2 Recommended browsers

41777

Use one of the following Internet browsers to correctly display the HTML pages of the web interface:

- Microsoft Internet Explorer (from version 8.0)
- Mozilla Firefox (from version 3.5)

4.4.3 Operating instructions

41723

Web interface: Access

41681

- ▶ PC / Laptop / mobile device: Start Internet browser.
- ▶ Internet browser: Enter IP address of the device in the address line (e.g. 192.168.82.2)
- > Internet browser displays the start page of the web interface.

Web interface: Navigation

41680

In the web interface, the pointing device (e.g. mouse, touchpad) is used instead of the following key functions:

- Navigation functions of the arrow keys [▼], [▲], [▶], [◀]
- Selecting functions of the function keys [Select] and [Back]

Example:

To select  > :

- ▶ Place the cursor on symbol [AS-i 1] in the main navigation bar.
- > Symbol [AS-i 1] has the focus.
- > Subnavigation bar appears.
- > Navigation trail shows actual position in the menu tree:
AS-i 1
- ▶ Place the cursor on symbol [Diagnostics] in the subnavigation bar.
- > Symbol [Diagnostics] has the focus.
- > Navigation trail shows actual position in the menu tree:
AS-i 1 > Diagnostics
- ▶ Click on symbol [Diagnostics]
- > Web browser shows menu page [Diagnostics]



Web interface: Password protection

41679

The web server has a basic password protection to prevent unwanted or unauthorised changes to the device settings via the web interface.

When the web interface is accessed, a status bar at the top shows if the user is logged in or logged out:

 Status: logged in

User is logged in:

- Full access to device settings
- Full access to diagnostics and information data

 Status: logged out

User is logged out:

- No access to device settings
- Access to diagnostics and information data





The password is: CAFE

The password protection cannot be deactivated! The password cannot be changed!

Web interface login

41676

- ▶ Go to the web interface (→ **Operating instructions** (→ S. 33)).
- > At the top of the web interface, the status bar displays the following status message:
 -  Status: logged out
- ▶ Enter the fixed password in the [Password:] field.
- ▶ Click [Login] to log in to the web interface.
- > The status bar displays the changed status:
 -  Status: logged in
- > The operator has unlimited access to all menus and functions of the web interface.



The operator remains logged in if one of the following actions is carried out:

- the web browser is closed and reopened
- the PC/laptop is restarted
- AC1403/04 is restarted

To prevent unauthorised access to the device settings:

- ▶ Manually log off before you leave the web interface! (→ **Disconnect from web interface** (→ S. 35))
- ▶ Remember to turn off the "Save password" function of your web browser before accessing the web interface!
- ▶ If the "Save password" function of your web browser is not turned off: delete the stored passwords in your browser settings!

Disconnect from web interface

41457

To log out of the web interface:

- ▶ Start web interface
- > Status line with status message is displayed at the top of the web interface:
 - 🔒 Status: logged in
- ▶ Log out of the web interface by clicking [Logout]
- > Status bar shows changed status
 - 🔓 Status: logged out
- > User can only access menus in the web interface containing diagnostic and information data.
- > An error message is displayed when a user in the web interface accesses a menu with device settings.



The user stays logged into the web interface even when the web browser is closed and then restarted.

To prevent unauthorised access to the device settings:

- ▶ After finishing the access via the web browser manually log out of the device web interface!
- ▶ When password memory function of the web browser is not deactivated: Delete all saved passwords in the browser settings!

5 Menu

Content

Start screen	36
Menu functions	37
Quick setup.....	38
AS-i 1 / AS-i 2	47
System.....	58
Interfaces.....	80
ifm system solutions	90

41740

This chapter describes the menu functions of the device's graphical user interface.

5.1 Start screen

41690

When starting the device, the start screen of the graphical user interface appears (special case: system start after initial commissioning or firmware update: → **Start screen 'Basic settings'** (→ S. [97](#))). The start screen displays the status information of important system components. Moreover, the graphical user interface is accessed and operated from the start screen.

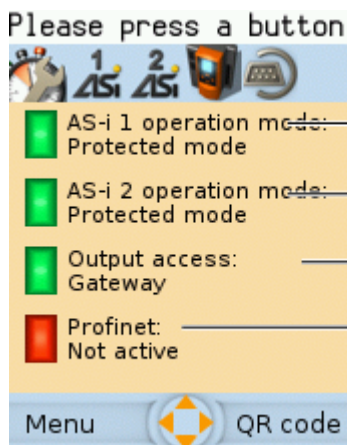

- ① AS-i Master 1 operation mode
→ **Operating mode of the AS-i master** (→ S. [106](#))
- ② AS-i Master 2 operation mode
→ **Operating mode of the AS-i master** (→ S. [106](#))
only available for devices with 2 AS-i masters
- ③ Control instance of the AS-i slave outputs
→ **Control instance of the AS-i outputs** (→ S. [106](#))
- ④ Status of the PROFINET connection
→ **Fieldbus status** (→ S. [106](#))







▶ Press [Menu] function key to go to the menu (→ **Menu functions** (→ S. [37](#)))

OR:

▶ Press [OSC] function key to go to the Online Support Center (→ **Online Support Center (OSC)** (→ S. [108](#)))

5.2 Menu functions

The main navigation bar of the AC1403/04 provides access to the following menus:

Symbol	Description
	Access to the most important device functions → System (→ S. 58)
	Configuration and diagnostics of the AS-i 1 network (AS-i master, AS-i slaves) → AS-i 1 / AS-i 2 (→ S. 47)
	Configuration and diagnostics of the AS-i 2 network (AS-i master, AS-i slaves)* → AS-i 1 / AS-i 2 (→ S. 47)
	Configuration and diagnostics of the device, control of the device-internal SPS → System (→ S. 58)
	Configuration and diagnostics of the interfaces (PROFINET, Configuration interface) → Interfaces (→ S. 80)
	Online Support Centre** → Online Support Center (OSC) (→ S. 108)
	Control and administration of the ifm system solutions (ifm apps)** → ifm system solutions (→ S. 90)

* ... only available for devices with 2 AS-i masters

** ... only available via the web interface of the device

5.2.1 Additional functions

Compared to the user interface of the display, the web interface offers the following additional functions:

- Download the device description file (GSDML file)
(→ **Download GSDML file** (→ S. [87](#)))
- Adopt date and time of a PC/laptop
(→ **Adopt the system time of the PC** (→ S. [74](#)))
- Save diagnostics protocol
(→ **Store diagnostic protocol** (→ S. [78](#)))
- Use ifm system solutions
(→ **ifm system solutions** (→ S. [90](#)))
- Diagnostics indications
(→ **Start screen: Status LEDs** (→ S. [106](#)))

5.3 Quick setup

42190

The [Quick setup] menu provides a fast access to the most important device functions.

Navigation path	Functions
	<ul style="list-style-type: none">→ Quick setup: Project AS-i networks (→ S. 39)→ Quick setup: Configure the operating mode of the AS-i masters (→ S. 40)→ Quick setup: Configure the output access (→ S. 41)→ Quick setup: Access the device via QR code (→ S. 42)→ Quick setup: Configure the PROFINET interface (→ S. 42)→ Quick setup: Set the Konfigurationsschnittstelle 1 (→ S. 43)→ Quick setup: Set the configuration interface 2 (→ S. 44)→ Quick setup: Address the AS-i slaves connected to AS-i Master 1 (→ S. 45)→ Quick setup: Address the AS-i slaves connected to AS-i Master 2 (→ S. 46)

5.3.1 Quick setup: Project AS-i networks

During projection adaptation, the AS-i master carries out the following actions:

- The configuration data of all detected AS-i slaves (LDS) is saved
- The detected AS-i slaves are added to the list of projected slaves (LPS)



During a project a projection adaptation all output parameters of the unconnected AS-i slaves are reset to their default value in the AS-i master (single /A slaves = 0xF, B slaves = 0x7).

To carry out the projection adaptation on AS-i master 1 and/or AS-i master 2:

1 Select menu page



- ▶ Select tab **Project all!**

2 Select the AS-i master for projection adaptation

- ▶ Set the following parameters as required:

Parameter	Description	Possible values	
[AS-i Master 1]	Select AS-i Master 1 for projection adaptation	<input type="checkbox"/>	Exclude AS-i Master 1 from projection adaptation
		<input checked="" type="checkbox"/>	Include AS-i Master 1 in projection adaptation
[AS-i Master 2]	Select AS-i Master 2 for projection adaptation (only available for devices with 2 AS-i masters)	<input type="checkbox"/>	Exclude AS-i Master 2 from projection adaptation
		<input checked="" type="checkbox"/>	Include AS-i Master 2 in projection adaptation

3 Start the projection adaptation

- ▶ Activate the button **Start projection process**.
- > The selected AS-i masters go into the "projection mode".
- > A projection adaptation is carried out on the selected AS-i masters.
- > After projection adaptation, the selected AS-i masters go into the "protected mode".

5.3.2 Quick setup: Configure the operating mode of the AS-i masters

41778



Information regarding the operating modes of an AS-i master: → **Operating modes of the AS-i master** (→ S. [118](#))

To configure the operating modes of the AS-i masters:

1 Select the menu page



- ▶ Select **[Operation modes]** tab.

2 Configure the operating mode of AS-i master 1 and the behaviour of the connected AS-i slaves

- > In group [AS-i master 1], set the following parameters as required:

Parameter	Description	Possible values	
[Projection mode]	Active operating mode of the AS-i master	<input type="checkbox"/>	Projection mode inactive: AS-i network runs in protected mode (normal mode)
		<input checked="" type="checkbox"/>	Projection mode active: AS-i network can be projected. (→ Quick setup: Address the AS-i slaves connected to AS-i Master 1 (→ S. 45) or → Quick setup: Address the AS-i slaves connected to AS-i Master 2 (→ S. 46))
[No slave reset]	Behaviour of the AS-i slaves when changing the operating mode	<input type="checkbox"/>	Slave is reset when changing the operating mode: When changing the operating mode, the AS-i slaves will be reset for a short moment (reset or offline phase).
		<input checked="" type="checkbox"/>	Slave is not reset when changing the operating mode: When changing the operating mode, the AS-i slaves continue to operate without interruption.

- > Selected values are applied.

3 Optional: set the operating mode of AS-i master 2 and the behaviour of the AS-i slaves

- ▶ Repeat step 2 for the group [AS-i master 2].

5.3.3 Quick setup: Configure the output access

Only one control instance at a time can have write access to the outputs of the connected AS-i slaves. The operator configures the control instance with the parameter [Output access].

To configure the control instance of the AS-i slave outputs:

1 Select the menu page



- ▶ Select [Operation modes] tab.

2 Set the control instance for the outputs of the AS-i slaves

- ▶ From the list [Output access], select the desired value:

Parameter	Description	Possible values	
[Output access]	Control instance of the AS-i slave outputs	[Gateway]	A higher-level PLC controls the outputs of the AS-i slaves.
		[Manual]	The operator controls the outputs of the AS-i slaves via the graphical user interface.
		[PLC]	The device-internal PLC controls the outputs of the AS-i slaves.

3 Save the changes

- ▶ Press [Accept selection] to save the changes.
- > The selected instance controls the outputs of the AS-i slaves.

5.3.4 Quick setup: Access the device via QR code

41765

The QR code (Quick Response Code) allows the operator to access the web interface of the device from a smartphone or tablet PC.

Requirements:

- The AS-i device must be connected to a wireless LAN router with switch functionality. (→ **Connection via Ethernet network** (→ S. [116](#)))
- The smartphone/tablet PC is connected to the wireless LAN router.
- The smartphone/tablet PC provides a camera function.
- The smartphone/tablet PC has a QR-code reader installed.

1 Select menu page

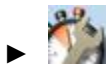

- ▶ Select the **QR-Code** tab.
- > The display shows the QR code.

2 Read the QR code

- ▶ Start the QR code reading app and scan the QR code.
- > The smartphone displays the web interface of the device (→ **Remote access** (→ S. [32](#))).

5.3.5 Quick setup: Configure the PROFINET interface

41779

To configure the PROFINET-interface:

1 Select menu page



- ▶ Select **Profinet** tab.

2 Set IP parameters of the PROFINET-interface

- > Set following parameters as requested:

Parameter	Description	Possible values
[IP address]	IP address of the PROFINET-interface	e.g. 192.168.10.3
[Subnet mask]	Netmask of the PROFINET-network segment	e.g. 255.255.255.0
[Gateway address]	IP address of the PROFINET-gateway	e.g. 192.169.10.1

3 Save changes

- ▶ Use **Accept** to save the changes.
- ▶ Selected values are applied.
- > PROFINET-Interface is accessible via the set address.

5.3.6 Quick setup: Set the Konfigurationsschnittstelle 1

41781

The device provides the following options for configuration of the Ethernet Konfigurationsschnittstelle 1:

- Manual = The operator sets the interface parameters (IP address, network mask, gateway address) manually.
- Automatic = The interface parameters are set automatically. The operator can choose between these protocols:
 - Dynamic Host Configuration Protocol (DHCP)
 - Zero Configuration Networking (Zeroconf)



The device must be connected to a DHCP server to automatically receive the interface parameters via DHCP.

- ▶ Connect the configuration interface (X3) to a DHCP server.

To configure the IP parameters of the configuration interface:

1 Select the menu page



- ▶ Select [Config. interface X3] tab.

2 Show the active settings

- > The parameters below show the active settings:

Parameter	Description	Possible values	
[Obtain IP address autom.]	Active method for the configuration of the interface parameters	<input type="checkbox"/>	Manual assignment of the interface parameters through the operator
		<input checked="" type="checkbox"/>	Automatic assignment of the interface parameters
[IP status]	Configuration protocol used	[Static]	The operator sets the IP parameters manually.
		[DHCP]	The IP parameters are set by a DHCP server.
		[Zeroconfig]	The IP parameters are set automatically with the Zeroconf protocol.
[IP address]	IP address of the interface	e.g. 192.168.0.100	
[Subnet mask]	Network mask of the network segment	e.g. 255.255.255.0	
[Gateway address]	IP address of the network gateway	e.g. 192.168.0.1	

- ▶ Take one of the following actions:
 - Configure the IP parameters manually: continue with → step 3
 - Configure the IP parameters automatically: continue with → step 4

3 Configure the IP parameters manually

- ▶ Uncheck [Obtain IP address autom].
- ▶ Set the following parameters as required:
 - [IP address]
 - [Subnet mask]
 - [Gateway address]
- ▶ Press [Accept] to save the changes.

- ▶ Continue with → step 5

4 Configure the IP parameters automatically

- ▶ Check [Obtain IP address autom].
- ▶ Press [Accept] to save the changes.
- > The device tries to obtain IP parameters from a DHCP server.
- > If the IP parameter configuration via DHCP server fails, the device will generate the IP parameters by means of the Zeroconf protocol.



The automatic configuration of the interface takes approx. 10 seconds.

5 Show the current settings

- > The parameters (→ step 2) show the active IP settings of the Konfigurationsschnittstelle 1.

5.3.7 Quick setup: Set the configuration interface 2

42159



Configuration interface 2 (X8) has the same configuration options as configuration interface 1 (X3).

→ **Quick setup: Set the Konfigurationsschnittstelle 1** (→ S. [43](#))

To configure configuration interface 2 (X8):

1 Select menu page



- ▶ Select tab [Config interface X8].

2 Configure interface

- ▶ Set the interface as required.

5.3.8 Quick setup: Address the AS-i slaves connected to AS-i Master 1

To change the address of an AS-i slave connected to AS-i Master 1:

1 Select the menu page



- ▶ Select **[Addressing AS-i 1]** tab.

2 Select the AS-i slave

- > The page provides an overview of the current addressing and status of the AS-i slaves on the selected AS-i master (→ figure)

Notes on colour codes: → **Overview of slave states**
(→ S. 25)

- ▶ Select the AS-i slave of which want to change the address.
- ▶ Use [Select] to activate the selected AS-i slave.

	0	1	2	3	4	5	6	7	8	9
0x A/B		█	█	█						
1x A/B			█	█						
2x A/B	█									
3x A/B										
	Slave active									

3 Select a new AS-i address

- > The page provides an overview of the free AS-i addresses (→ figure)

Notes on colour codes: → **Overview of free slave addresses** (→ S. 27)

- ▶ Select the address to be assigned to the AS-i slave.
- ▶ Assign the selected address with [Select].

	0	1	2	3	4	5	6	7	8	9
0x A/B	█				█	█	█	█	█	█
1x A/B	█					█				
2x A/B	█	█	█	█	█	█	█	█	█	█
3x A/B	█	█								
	Free									

- > The confirmation prompt appears.
- ▶ Confirm the message with [OK].
- > The AS-i slave has new address.
- > The page provides an overview of the current addressing and configuration errors (→ figure)

	0	1	2	3	4	5	6	7	8	9
0x A/B	█	█	█							
1x A/B			█	█		█				
2x A/B	█									
3x A/B										
	Not projected									

4 Address additional AS-i slaves (optional)

- ▶ Repeat steps 2 and 3 to address additional AS-i slaves.



After the address change, the present configuration no longer corresponds to the stored configuration.

- > The slave status indicates a configuration error.

To eliminate the configuration error:

- ▶ Start a projection adaptation (→ **Quick setup: Project AS-i networks** (→ S. 39)).

5.3.9 Quick setup: Address the AS-i slaves connected to AS-i Master 2

41763



The procedure for addressing the AS-i slaves connected to AS-i Master 2 is the same as for addressing the AS-i slaves connected to AS-i Master 1 (→ **Quick setup: Address the AS-i slaves connected to AS-i Master 1** (→ S. [45](#))).

To change the address of an AS-i slave connected to AS-i Master 2

1 Select the menu page



- ▶ Select **Addressing AS-i 2** tab.

2 Change the AS-i slave address





- ▶ Address AS-i slaves.

5.4 AS-i 1 / AS-i 2

The [AS-i 1] and [AS-i 2] menus provide access to configuration functions of the AS-i networks.

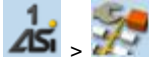
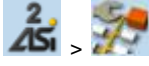

The [AS-i 2] menu is only available for devices with two AS-i masters!

Navigation path	Content
 	AS-i master settings → Set the operating mode of the AS-i master (→ S. 48) → Carry out a projection adaptation (→ S. 49) → Set the monitoring functions of the AS-i master (→ S. 49)
 	AS-i network diagnosis → Display and reset the error counters (→ S. 50) → Display the error statistics of the AS-i slaves (→ S. 50) → Display the voltage supply analysis (→ S. 51) → Display and reset performance data (→ S. 51)
 	AS-i slave settings → Display the input/output data of the AS-i slave (→ S. 52) → Change the digital output values manually (→ S. 54) → Change the analogue output values manually (→ S. 55) → Show AS-i slave information (→ S. 55) → Change an AS-i slave address (→ S. 56) → Change an AS-i slave parameter output (→ S. 56) → Change the Extended ID1 of the AS-i slave (→ S. 57)

5.4.1 AS-i 1 / AS-i 2: Master setup

41537

The menu item [Master setup] provides access to the configuration options of the selected AS-i master.

Set the operating mode of the AS-i master

41640



More information on the operating modes of the AS-i master: → **Operating modes of the AS-i master** (→ S. [118](#))

To set the operating mode of the AS-i master:

1 Select the menu page

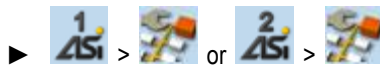

2 Set the operating mode of AS-i master 1 and the behaviour of the connected AS-i slaves

> Set the following parameters as required:

Parameter	Description	Possible values	
[Projection mode]	Active operating mode of the AS-i master	<input type="checkbox"/>	Projection mode inactive: AS-i network operates in protected mode (normal mode)
		<input checked="" type="checkbox"/>	Projection mode active: AS-i network can be projected.
[No slave reset]	Behaviour of the AS-i slaves when changing the operating mode	<input type="checkbox"/>	Slave is reset when changing the operating mode: When changing the operating mode, the AS-i slaves will be reset for a short moment (reset or offline phase).
		<input checked="" type="checkbox"/>	Slave is not reset when changing the operating mode: When changing the operating mode, the AS-i slaves continue to operate without interruption.

> Selected values are applied.

Carry out a projection adaptation

41535

During projection adaptation, the AS-i master stores the configuration of all AS-i slaves currently found on the AS-i network in its memory and assigns a valid AS-i address to each of them.



The projection adaptation can only be carried out in projection mode:

- ▶ [Projection mode] must be checked (→ **Set the operating mode of the AS-i master** (→ S. 48)).
- ▶ During a Projection process all output parameter of not connected AS- slaves in the AS-i master will be reset to their default values (single / A slaves = 0xF, B slaves = 0x7).

To launch the projection adaptation:

1 Select the menu page

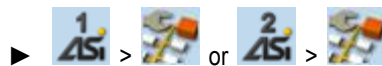

2 Carry out a projection adaptation

- ▶ Press **[Start projection process]** button.
- > The projection adaptation is carried out.

If successful:

- > All slaves on the AS-i master are projected.

If not successful:

- > The Online Support Center displays an error message.
- ▶ Remove the error and repeat the process.

Set the monitoring functions of the AS-i master

41641

To set the monitoring functions of the selected AS-i master:

1 Select the menu page

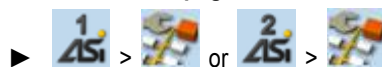

2 Set the monitoring functions of the AS-i master

- ▶ Set the following parameters as required:

Parameter	Description	Possible values	
[Automatic addressing]	Behaviour if AS-i slave is replaced (→ Protected mode (→ S. 118))	<input type="checkbox"/>	Automatic addressing disabled
		<input checked="" type="checkbox"/>	Automatic addressing enabled
[Earth fault detection]	Detection of earth faults	<input type="checkbox"/>	Do not detect earth faults in the AS-i system
		<input checked="" type="checkbox"/>	Detect earth faults in the AS-i system
[Double address detection]	Double address detection	<input type="checkbox"/>	Do not detect AS-i slaves with the same address
		<input checked="" type="checkbox"/>	Detect AS-i slaves with the same address

- > Selected values are applied.

5.4.2 AS-i 1 / AS-i 2: Diagnosis

41538

The [Diagnosis] menu provides access to the diagnostic data of the selected AS-i network.

Display and reset the error counters

41445

To display and reset the AS-i error counters:

1 Select the menu page



- ▶ Select [Error counters] tab.

2 Display the error counters

- > Page shows the following information:

Name	Description
[Telegrams]	Number of message errors that occurred
[Configuration]	Number of configuration errors that occurred
[Voltage < 22.5V]	Number of voltage errors < 22.5 V
[Voltage < 19.0V]	Number of voltage errors < 19.0 V
[Earth fault]	Number of detected earth faults

3 Optional: reset the error counters

- ▶ Press [Reset] button.
- > All error counters are reset to 0.

Display the error statistics of the AS-i slaves

41437

To display the error messages of the AS-i slaves on the selected AS-i master:

1 Select the menu page



- ▶ Select [Errors / slave] tab.

2 Display the error statistics of the AS-i slaves

- > Page shows the following information:

Column header	Description
[Address]	Address of the AS-i slave
[S/A]	Number of errors of the single or A slave at this address
[B]	Number of errors of the B slave at this address

- ▶ Use [▲] / [▼] to scroll through the table.

Display the voltage supply analysis

41502

To display the voltage supply analysis:





1 Select the menu page



- ▶ Select **[Power supply]** tab.

2 Display the voltage supply analysis

- > Page shows the following information:

Name	Description	Possible values	
[Power supply]	Method of voltage supply	[Aux]	Voltage is supplied separately by the AS-i network and AUX 24 V.
		[AS-i]	Voltage is only supplied by the AS-i network.
		[Power24]	Voltage is supplied by data decoupling module.
[AS-i voltage]	AS-i voltage measured (in [V])	e.g. 30.3 V	
[DC earth fault]	Evaluation of the network symmetry		AS-i network is symmetrical
			AS-i network is asymmetrical
			AS-i network has earth fault
		Graphical representation of the network symmetry: 	

Display and reset performance data

41460

To display the performance statistics of the selected AS-i master:

1 Select the menu page



- ▶ Select **[Performance]** tab.

2 Display performance data

- > Page shows the following information:

Designation	Description
[Activated slaves]	Number of active AS-i slaves on the AS-i network
[AS-i cycle time [ms]]	AS-i cycle time (value in [ms])
▪ [minimum]	shortest cycle time
▪ [maximum]	longest cycle time
▪ [current]	current cycle time

3 Optional: reset the performance data

- ▶ Press **[Reset]** button.
- > The saved statistic data for minimum and maximum cycle times are deleted.

5.4.3 AS-i 1 / AS-i 2: AS-i slaves

41539

The [AS-i Slaves] menu provides access to information and configuration options of the AS-i slaves.



The scope of configuration options shown ([Data] and [Setup] tab) varies according to the status of the selected AS-i slaves.

Display the input/output data of the AS-i slave

41438

To display the input/output data or the parameter output of the selected AS-i slaves:

1 Select the menu page



- ▶ Select an AS-i slave (→ **Slave selector** (→ S. 24)).
- ▶ Select **[Data]** tab.

2 Display input/output data

- > Depending on the profile of the selected AS-i slave, the page displays the following data:

Digital input

41464

Name	Description	Example / Possible values
[Inputs]	Current values of the digital inputs (binary and hexadecimal representation)	
		<input type="checkbox"/> Data bit is switched off (0 / OFF)
		<input checked="" type="checkbox"/> Data bit is switched on (1 / ON)

Analogue input

41528

Name	Description	Example / Possible values
[Inputs]	Current values of the analogue input channels and information about their status	
▪ [Valid]	The Valid bit indicates whether the displayed value is valid.	<input type="checkbox"/> Invalid value <input checked="" type="checkbox"/> Valid value
▪ [Overflow]	The Overflow bit indicates whether the displayed value is within the value range.	<input type="checkbox"/> Value within valid value range <input checked="" type="checkbox"/> Valid value range exceeded

Digital output

41465

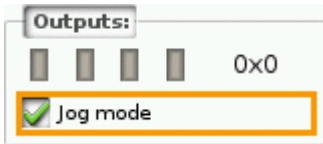
Designation	Description	Example / Possible values
[Outputs]	Current values of the digital outputs (binary and hexadecimal representation)	
		<input type="checkbox"/> Data bit is switched off (0 / OFF)
		<input checked="" type="checkbox"/> Data bit is switched on (1 / ON)
▪ [Jog mode]	The parameter controls the behaviour of the outputs in the event of a changed output value.	<input type="checkbox"/> Jog mode disabled ("switch mode") > The changes do not affect the output until you quit the editing mode.
		<input checked="" type="checkbox"/> Jog mode enabled ("momentary switch mode") > The changes immediately affect the output.

Analogue output

41521

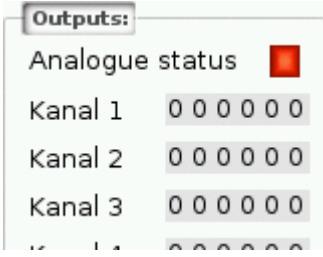
Name	Description	Example / Possible values
[Outputs]	Current values of the analogue output channels and information about their status	
▪ [Analogue status]	Current status of the analogue outputs	<input checked="" type="checkbox"/> Not O.K. <input checked="" type="checkbox"/> O.K.
▪ [Channel x]	Current value of the analogue output channel x (x = 1...n; n = number of channels per AS-i slave)	per digit: 0 ... 9

Parameter input

41787

Name	Description	Example / Possible values
[Parameter input]	Current value of the parameter input (binary and hexadecimal representation)	
		<input type="checkbox"/> Data bit is switched off (0 / OFF)
		<input checked="" type="checkbox"/> Data bit is switched on (1 / ON)

Change the digital output values manually



WARNING!

The manual change of digital output values may cause undesired consequences to the control process.

- > Risk of personal injury!
- > Risk of material damage to the machine/plant!

The operator is responsible for any consequences caused by the manual change of the digital output values!

- ▶ Secure the concerned area.
- ▶ Only trained personnel is allowed to set outputs manually.

If the jog mode is deactivated: After changing the slave outputs the output values remain on the changed values.

- ▶ Change the inverted outputs again immediately to the original values after the end of the test!

To change the digital output values of an AS-i slave manually:

1 Enable manual access to the outputs

- ▶ Set [Output access] parameter = Manual (→ **Set the output access** (→ S. 66)).

2 Select the menu page



- ▶ Select an AS-i slave (→ **Slave selector** (→ S. 24)).
- ▶ Select **[Data]** tab.

3 Set the digital output values manually

- > The group [Outputs] displays the current value of the digital output (binary and hexadecimal representation).
- ▶ Set [Jog mode] as required. (→ **Digital output** (→ S. 53))
- ▶ Change the desired output value bit by bit.
- > Selected value is applied.

Change the analogue output values manually

41598

To change the analogue output values of an AS-i slave manually:

1 Enable manual access to the outputs

- ▶ Set [Output access] parameter = Manual (→ **Set the output access** (→ S. 66)).

2 Select the menu page



- ▶ Select an AS-i slave (→ **Slave selector** (→ S. 24)).
- ▶ Select **[Data]** tab.

3 Set the analogue output values manually

- > [Outputs] group shows the current value of the analogue output.
- ▶ Change the value of the requested channel one digit at a time (→ **Numerical field** (→ S. 30)).
- > Selected value is applied.
- ▶ Optional: repeat step 3 to change further channels.

Show AS-i slave information

41643

To display information about an AS-i slave:

1 Select the menu page



- ▶ Select an AS-i slave (→ **Slave selector** (→ S. 24)).
- ▶ Select **[Information]** tab.

2 Display information about the AS-i slave

- > Page shows the following information:

Name	Description	Possible values												
[AS-i slave address]	Current address of the AS-i slave	e.g. 13B												
[Slave status]	Current status of the AS-i slave	<table border="1"> <tr> <td></td> <td>AS-i slave is active</td> </tr> <tr> <td></td> <td>AS-i slave is missing</td> </tr> <tr> <td></td> <td>Not projected</td> </tr> <tr> <td></td> <td>Double address error</td> </tr> <tr> <td></td> <td>Periphery fault</td> </tr> </table>		AS-i slave is active		AS-i slave is missing		Not projected		Double address error		Periphery fault		
	AS-i slave is active													
	AS-i slave is missing													
	Not projected													
	Double address error													
	Periphery fault													
[AS-i slave profile]	Current (= Current) and expected (= Preset) slave profile (IO, ID, ID2, ID1) in hexadecimal format	<div style="border: 1px solid grey; padding: 5px;"> <p>AS-i slave profile:</p> <table border="1"> <tr> <td>IO</td> <td>ID</td> <td>ID2</td> <td>(ID1)</td> </tr> <tr> <td>Current:</td> <td>3</td> <td>f</td> <td>f (f)</td> </tr> <tr> <td>Preset:</td> <td>3</td> <td>f</td> <td>f (f)</td> </tr> </table> </div>	IO	ID	ID2	(ID1)	Current:	3	f	f (f)	Preset:	3	f	f (f)
IO	ID	ID2	(ID1)											
Current:	3	f	f (f)											
Preset:	3	f	f (f)											

- ▶ Use [▲]/[▼] for page navigation.

Change an AS-i slave address

To change the address of an AS-i slave:

1 Select the menu page



- ▶ Select an AS-i slave (→ **Slave selector** (→ S. 24)).
- ▶ Select **[Setup]** tab.

2 Change the address of the AS-i slave

- ▶ Press the **[Change slave address]** button.
 - > The page displays an overview of the free AS-i addresses (→ **Overview of free slave addresses** (→ S. 27)).
- ▶ Select the address to be assigned to the AS-i slave and confirm with [Select] function key.
 - > Security prompt appears.
- ▶ Press [OK] to confirm the security prompt.
 - > The AS-i slave has a new address.
 - > The page displays an overview of the AS-i slave states (→ **Overview of slave states** (→ S. 25)).

3 Optional: change further AS-i addresses.

- ▶ Repeat step 2 to change further AS-i slave addresses.



After the address change, the present configuration (LDS) no longer corresponds to the stored configuration (LPS).

- > The OSC displays a configuration error.

To remove the configuration error:

- ▶ start a projection adaptation (→ **Carry out a projection adaptation** (→ S. 49)).

Change an AS-i slave parameter output

To change the parameter output of an AS-i slave:

1 Enable manual access to the outputs

- ▶ Set [Output access] parameter = Manual (→ **Set the output access** (→ S. 66))

2 Select the menu page



- ▶ Select an AS-i slave (→ **Slave selector** (→ S. 24)).
- ▶ Select **[Setup]** tab.

3 Change the parameter output of the AS-i slave

- > The [Parameter output] group displays the current assignment of the parameter output (binary and hexadecimal representation).
- ▶ Adjust the desired output value one position at a time.
- > Selected value is applied.

Change the Extended ID1 of the AS-i slave

To set the Extended ID1 of an AS-i slave:

1 Select the menu page



- ▶ Select an AS-i slave (→ **Slave selector** (→ S. [24](#))).
- ▶ Select **[Setup]** tab.

2 Set the Extended ID1

- > The [ID1] list displays the current Extended ID1 value (hexadecimal format).
- ▶ Select the desired value for Extended ID1 from the [ID1] list.
- > Selected value is applied.











After changing the Extended ID1, the existing configuration no longer corresponds to the stored configuration:

- > An error message appears (configuration error).
- ▶ Start a projection adaptation (→ **Carry out a projection adaptation** (→ S. [49](#))).

5.5 System



The [System] menu provides access to functions that allow configuration of the system and the device-internal SPS.

Navigation path	Functions
 > 	Device-internal SPS → System: Programmable Logic Controller (PLC) (→ S. 59)
 > 	System information → Show version information (→ S. 65)
 > 	System settings → Set the output access (→ S. 66) → Enable/Disable the device-internal PLC (→ S. 67) → Adjust device cycle (→ S. 68) → Switch the menu language (→ S. 69) → Set the behaviour of the display (→ S. 70) → Set the system time manually (→ S. 72) → Synchronise the system time with an NTP server (→ S. 73) → Adopt the system time of the PC (→ S. 74) → Export device configuration (→ S. 76) → Import device configuration (→ S. 77) → System reset (→ S. 78) → Store diagnostic protocol (→ S. 78)
 > 	System diagnostics → Display diagnostic data (→ S. 79)

5.5.1 System: Programmable Logic Controller (PLC)

41671

The [PLC] menu provides access to the device-internal SPS.

Navigation path	Functions
	SPS information: → Display the status of the CODESYS SPS (→ S. 60) → Display information about SPS projects (→ S. 60)
	SPS settings → Control a single SPS application (→ S. 61) → Control SPS applications (→ S. 62) → Show target visualisation (→ S. 63)
	SPS diagnosis → Show memory used (→ S. 64)



For information about the programming of the device-internal SPS with CODESYS, please refer to the programming manual:

→ www.ifm.com > product page > [Downloads]

PLC: Information

41796

The [Information] menu item provides access to the SPS status and project information.

Display the status of the CODESYS SPS

41467

To display information about the current status of the device-internal SPS:

1 Select the menu page



▶ Select **Status** tab.

2 Display the status of the CODESYS SPS

> Page shows the following information:

Name	Description	Possible values	
Status LED	Status of the device-internal SPS		The CODESYS SPS is disabled.
			The CODESYS SPS is enabled.
[Version]	CODESYS version	e.g. 3.5.3.60	
[Node name]	Name of device in CODESYS project	e.g. ifm_SmartPLC_DataLine	

Display information about SPS projects

41440

To obtain information about the CODESYS project stored on the device-internal SPS:

1 Select the menu page



▶ Select **Project** tab.

2 Display information about SPS projects

> Page shows the following information:

Name	Description
[Project]	Name of the CODESYS project file
[Title]	Name of the CODESYS project
[Version]	Version number of the CODESYS project
[Author]	Author of the CODESYS project

PLC: Settings

41801

The [Settings] menu item provides access to the SPS applications (apps) on the device.

Control a single SPS application

41576

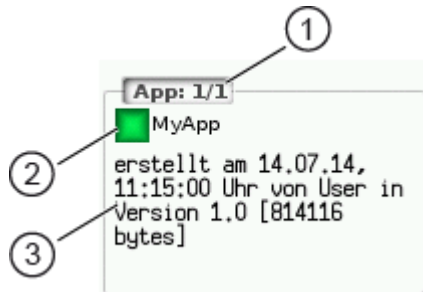

- ① [App x/y]
 – x ... number of the app displayed
 – y ... total number of apps stored
- ② Status and name of the application
 ■ = application has been stopped
 ■ = application has been started
- ③ Information concerning the application
 – date and time of creation
 – author
 – version of application
 – size

To control a single SPS application stored on the device:

1 Select the menu page



- ▶ Select [Applications] tab.

2 Select an application

- ▶ Use [▼] to select the message field.
- > The focus (orange frame) is on the message field.
- ▶ Use [▼] / [▲] to select the requested application.
- ▶ Perform one of the following actions:
 - Launch a single SPS application: continue with → step 3
 - Stop a single SPS application: continue with → step 4

3 Launch a single PLC application

- ▶ Press [Start] to launch the selected SPS application.
- > The confirmation prompt appears.
- ▶ Press [OK] to confirm the prompt.
- > The SPS application is started.
- ▶ Continue with → step 5

4 Stop a single SPS application

- ▶ Press [Stop] to stop the selected application.
- > The confirmation prompt appears.
- ▶ Press [OK] to confirm the prompt.
- > The application is stopped.

5 Display information about the SPS application

- > The status display of the SPS application is updated

Control SPS applications

To control all SPS applications stored on the device:

1 Select the menu page



- ▶ Select **[All applications]** tab.

2 Display status information about the SPS applications

- > Page shows the following information:

Designation	Meaning
[Total]	Number of applications stored on the device
[Started]	Number of applications running

- ▶ Perform one of the following actions:
 - Launch all SPS applications: continue with → step 3
 - Stop all SPS applications: continue with → step 4
 - Reset all SPS applications: continue with → step 5

3 Launch all SPS applications

- ▶ Press **[Starten]** button.
- > The confirmation prompt appears.
- ▶ Press [OK] to confirm the prompt.
- > All SPS applications are started.
- ▶ Continue with → step 6

4 Stop all SPS applications

- ▶ Press **[Stop]** button.
- > The confirmation prompt appears
- ▶ Press [OK] to confirm the prompt.
- > All SPS applications are stopped.
- ▶ Continue with → step 6

5 Reset all SPS applications

- ▶ Press **[Reset]** button.
- > The confirmation prompt appears.
- ▶ Press [OK] to confirm the prompt.
- > All SPS applications are reset and stopped.

6 Display the status of the SPS applications

- > The page shows updated information about the stored SPS applications.
- > The status of the **[Start]**, **[Stop]** and **[Reset]** buttons is updated.

Show target visualisation

41662

Using the CODESYS programming system, the user can optionally program a target visualisation to create an application-specific user interface for the display of AC1403/04. The target visualisation is loaded onto the device together with the CODESYS project, but it must be activated manually.



If no valid target visualisation is stored on the device, a green screen appears after activating the **[Activate Target-Visu]** button

To exit the target visualisation and return to the menu page:

- ▶ Press [**◀**] and [**▶**] simultaneously.

If the device does not react when entering [**◀**] + [**▶**], the key combination is deactivated.

- ▶ Activate the key combination using the system command "Show target visualisation" (→ Device Manual Supplement, **Command 0x0110 – Display target visualisation!**)

To activate the target visualisation:

1 Select menu page



- ▶ Select the **[Activate TargetVisu]** tab.

2 Start the target visualisation

- ▶ Press **[Activate Target-Visu]** button.
- > The confirmation message appears.
- ▶ Press **[OK]** button to confirm the message.
- > The display shows the target visualisation.

PLC: Diagnosis

41797

The [Diagnosis] menu item provides access to diagnostic data of the device-internal SPS.

Show memory used

41663

To display information about the memory capacity currently used:

1 Select the menu page



- ▶ Select [Memory] tab.

2 Show memory used

- > Page shows the following information:

Name	Description
[CODESYS]	Memory capacity occupied by CODESYS data (in Kbytes)
[free]	Free memory (in Kbytes)



The current usage of memory space is read out once when calling up the menu page. These values are not refreshed while the menu page is displayed. Any changes regarding the memory capacity (e.g. through download of a new CODESYS project) will therefore not be reflected in the displayed values.

To update the displayed values:

- ▶ Quit the [Diagnosis] menu page.
- ▶ Access the [Diagnosis] menu page again.
- > The menu page displays the current memory usage of device.

5.5.2 System: Information

41672

The [Information] menu item provides access to the version information about the system components.

Show version information

41661

To display information about the hardware and software components of the device:

1 Select the menu page

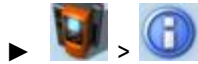

- ▶ Select **[Version]** tab.

2 Show version information

- > Page shows the following information:

Name	Description	Possible values
[Modell]	Article number of the device	e.g. AC1403/04
[SN]	Serial number of the device	e.g. 000000113034
[Build]	Version number of the installed firmware	e.g. 4.2.x
[HW version]	Version number of the device main board	e.g. AA

5.5.3 System: Setup

41670

The [Setup] menu item provides access to the configuration options of the system.

Set the output access

41645

To set the control instance for the outputs of the AS-i slaves:

1 Select the menu page



- ▶ Select [System settings] tab.

2 Configure the control instance for the outputs of the AS-i slaves

- ▶ Set the following parameters as required:

Name	Description	Possible values	
[Output access]	Control instance of the AS-i slave outputs	[Gateway]	A higher-level PLC controls the outputs of the AS-i slaves.
		[Manual]	The operator controls the outputs of the AS-i slaves via the graphical user interface.
		[PLC]	The device-internal PLC controls the outputs of the AS-i slaves.

3 Save the changes

- ▶ Press [Accept selection] to save the changes.
- > The selected instance controls the outputs of the AS-i slaves.



If the value PLC is selected, the system will automatically enable the device-internal PLC (→ **Enable/Disable the device-internal PLC** (→ S. [67](#))).

Enable/Disable the device-internal PLC

NOTICE!

When disabling the device-internal PLC, all running PLC applications will be stopped. This could have undesirable effects on the controlled process if the PLC figures as the control unit for the AS-i slave outputs.

Risk of material damage to the machine/plant!

- ▶ The PLC application should be terminated in a controlled manner before disabling the device-internal PLC!
(→ **Control SPS applications** (→ S. [62](#)))

- ▶ Implement a safe state when programming the PLC applications!

When activating the device-internal PLC, PLC applications stored on the device are started automatically.

- ▶ Implement a safe start state when programming the PLC applications!

To set the internal Programmable Logic Controller (PLC):

1 Select the menu page

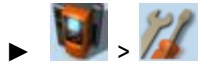

- ▶ Select **[System settings]** tab.

2 Enable/Disable the device-internal PLC

- > Set the following parameters as required:

Parameter	Description	Possible values	
[Use PLC]	State of the device-internal CODESYS PLC	<input type="checkbox"/>	Device-internal PLC is disabled.
		<input checked="" type="checkbox"/>	Device-internal PLC is enabled.

- > Selected value is applied.

Adjust device cycle

NOTICE!

A device cycle that is too short can have undesirable effects on the correct transmission of the process and control data between the PLC and peripheral devices (higher-level PLC, AS-i slaves).

If a device cycle that is too long is selected, the connection between the device and the higher-level Profinet master can be interrupted.

- > Risk of material damage to the machine/plant!
- ▶ Select a device cycle between 1.5 to 2 milliseconds!



If the PLC is disabled, the device operates with a fixed cycle time of 0.7 ms.

To set the device cycle:

1 Select menu page



- ▶ Select the **System settings** tab.

2 Set the device cycle

- ▶ Set the following parameters as required:

Parameter	Description	Possible values	
[Device cycle]	Active → Gerätezyklus .	[1.5 ms]	1.5 milliseconds
		[2.0 ms]	2.0 milliseconds
		[2.5 ms]	2.5 milliseconds
		[3.0 ms]	3.0 milliseconds

3 Save changes

- ▶ Activate the **Accept selection** button.
- > Selected value is applied.

Switch the menu language

41701

To select the language of the GUI texts:

1 Select the menu page

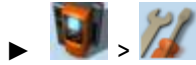

- ▶ Select **System settings** tab.

2 Select the menu language

- > The [Language] list shows the active language in which the GUI texts are displayed.
- ▶ Set the following parameters as required:

Parameter	Description	Possible values	
[Language]	Language in which the GUI texts are displayed	[Deutsch]	German
		[English]	English
		[Français]	French
		[Español]	Spanish
		[Italiano]	Italian
		[Português]	Portuguese

3 Save the changes

- ▶ Press **Accept selection** button.
- > GUI elements are displayed in the requested language.

Optional: switch the language with a key combination

41731

The languages available on the device are saved in an ordered list:

- German
- English
- French
- Spanish
- Italian
- Portuguese

To switch the language with a key combination (from the active language):

- ▶ Press **▶** + **▲** to select the previous language in the list.

OR:

- ▶ Press **▶** + **▼** to select the next language in the list.
- > GUI elements are displayed in the requested language.



The key combination allows you to change the language from any menu page.

Set the behaviour of the display

41651

To set the display behaviour (screen saver, behaviour in case of inactivity):

1 Select the menu page

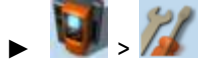

- ▶ Select **System settings** tab.

2 Set the behaviour of the display

- ▶ Set the following parameters as required:

Parameter	Description	Possible values	
[Screen saver]	Status of the screen saver	<input type="checkbox"/>	Screen saver is inactive: Display remains permanently switched on.
		<input checked="" type="checkbox"/>	Screen saver is active: Display is switched off after 10 minutes of inactivity.
[Return to start screen]	Display behaviour in case of extended period of user inactivity	<input type="checkbox"/>	The currently selected menu page stays on the screen.
		<input checked="" type="checkbox"/>	When the set time has elapsed, the display automatically changes to the start screen.

- > Selected values are applied.

Set the system time

The system time consists of date and time. The device provides the following options for setting the system time:

- **Manual:** The operator sets the date and time manually.
- **Via NTP server:** The device has an NTP client. The system time can be synchronised with an NTP server.
- **Apply the system time of a PC/laptop:** The device adopts the system time of a PC/laptop (only available via the web interface of the device)

To set the system time:

1 Select the menu page

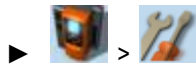

- ▶ Select **[Clock]** tab.

2 Display the current system time settings

- > The following parameters display the current system time settings:

Parameter	Description	Possible values	
[Activate NTP]	Activate the NTP client of the device	<input type="checkbox"/>	NTP client is deactivated: Device adopts the manually set values for [Time] and [Date].
		<input checked="" type="checkbox"/>	NTP client is not active: From an NTP server, the device adopts the values for [Time] and [Date].
Status LED	Status of NTP client and synchronisation with NTP server	[NTP not active <input type="checkbox"/>	NTP client is deactivated: Applicable are the manually set values for [Time] and [Date].
		[NTP waiting <input type="checkbox"/>	NTP client is active: Device waits for messages from NTP server.
		[NTP successful <input type="checkbox"/>	NTP client is active: Time synchronisation with NTP server was successful.
[Time]	System time (format [hh:mm:ss])	e.g. 12:23:56	
[Date]	System date (format [yyyy-mm-dd])	e.g. 2014-04-23	

3 Select the configuration method

- ▶ Select one of the following:
 - **Set the system time manually** (→ S. [72](#))
 - **Synchronise the system time with an NTP server** (→ S. [73](#))
 - **Adopt the system time of the PC** (→ S. [74](#))

Set the system time manually

To set the system time manually:

1 Select the menu page



- ▶ Select **[Clock]** tab.

2 Deactivate the NTP client of the device

- ▶ Uncheck [Activate NTP] (→ **Set the system time** (→ S. [71](#))).
- ▶ Press **[Accept selection]** button.
- > The changes become effective.
- > NTP status: [NTP not active

3 Set the system time manually

- ▶ Set [Time] and [Date] (Operating notes: → **Numerical field** (→ S. [30](#)))
- > Selected values are applied.



Seconds cannot be changed manually. When leaving the edit mode, the seconds will be automatically set to 0.

Synchronise the system time with an NTP server

To synchronise the system time with an NTP server:



To synchronise the system time and date via Network Time Protocol (NTP), connect the configuration interface of the device to an NTP server directly or over a network.

1 Select the menu page



- ▶ Select **[Clock]** tab.

2 Deactivate the NTP client

- ▶ Uncheck [Activate NTP] (→ **Set the system time** (→ S. 71)).
- > The IP address field and the [NTP-Offset] list can be edited.

3 Set the IP address of the NTP server and NTP offset

- ▶ Set the following parameters as required:

Parameter	Description	Possible values	
IP address field	IP address of the NTP server	e.g. 192.168.0.100	
[NTP-Offset] (optional)	Time zone of the NTP server in UTC (Universal Coordinated Time).	[no offset]	System time is taken from NTP server without offset
		[UTC -12:00 ... UTC +12:00]	Adopt time zones according to UTC division (displayed number of hours will be added/subtracted)

- ▶ Press **[Accept selection]** button.
- ▶ The device tries to synchronise the system time with the NTP server.
- > NTP status: [NTP waiting

In case of a successful synchronisation:

- > NTP status: [NTP successful
- > [Time] and [Date] show the synchronised values.

In case of a failed synchronisation:

- ▶ Check the settings of the IP parameters of the configuration interface.
- ▶ Check the IP address of the NTP server.
- ▶ Repeat the process.

Adopt the system time of the PC

To adopt the date and time of a PC/laptop:



This function is only available via the web-interface of the device (→ **Remote access** (→ S. [32](#))).

Requirements:

- ▶ Connect the device with PC/laptop (→ **Configuration interfaces: Connection concepts** (→ S. [115](#))).
- ▶ Start the web browser and open the web interface of the device (→ **Recommended browsers** (→ S. [32](#))).



This function can only be executed via the web interface of the device.

1 Select the menu page

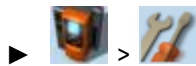

- ▶ Select the **Clock** tab.

2 Adopt the system time of the PC/laptop

- ▶ Uncheck [Activate NTP] (→ **Set the system time** (→ S. [71](#))).
- ▶ In group [Apply Time and Date from the PC]: Press [OK] button.
- > The device applies the date and time of the PC/laptop.
- > [Date] and [Time] display the system time.

Clone device configuration

41593



This function is only available via the local user interface of the device!

The device makes it possible to create an image of the current device configuration, to transfer it to another device and activate it there (clone). The export and import of the configuration file takes place via an SD card.

A device configuration consists of the following settings:

- System settings
- AS-i 1/AS-i 2 settings
- PROFINET settings
- SPS applications (incl. PLC task configuration, variables and data)



Cloning a device configuration is only possible if the following conditions are met.

- The firmware versions of the source device and the target device are compatible (compatible = versions are identical in the major release and minor release, e.g. V3.2. is compatible with V3.2.2, but: V3.2.1 is incompatible with V3.3.1).
- Source and target device have the same article number.

Export device configuration

NOTICE!

During the export the control functions of the device are not available.

- > Risk of undesired system behaviour
- ▶ Do not export the device configuration during operation of the plant!

NOTICE!

An interruption of the export can lead to a faulty export file.

- > Risk of data loss
- ▶ Do not disconnect the device during the export.
- ▶ Only start the export after the boot application has been successfully generated.
- ▶ Do not remove the SD card from the device before the export is completed.



The SD card has to be formatted with the FAT32 file system. SD cards with other file systems are not recognised by the AC1403/04.

To allow identification of the saved configuration the export file is saved using the following name convention:

`ifm_DevID_XXXXXXXXXX_YYYYMMDDhhmmss.icnf`

- DevID Article number of the device
- XXXXXXXXXXXX Serial number of the device
- YYYYMMDDhhmmss Timestamp of the saved file
(YYYY = year, MM = month, DD = day, hh = hours, mm = minutes, ss = seconds)

To save the current device configuration on an SD card:

1 Select menu page



- > Select **[Configuration]** tab.

2 Save the device configuration

- ▶ Insert an empty, formatted SD card in the SD card slot of the device.
- ▶ Activate the **[Export configuration]** button.
- > The device saves the current configuration on the SD card. The device stores the current configuration on the SD card.

Import device configuration

NOTICE!

During the import the control functions of the device are not available. During the import the device reboots.

- > Risk of undesired system behaviour
- ▶ Do not import the device configuration during operation of the plant!

NOTICE!

An interruption of the import can lead to a faulty device configuration.

- > Risk of data loss
- ▶ Do not disconnect the device during the import.
- ▶ Do not remove the SD card from the device before the import is completed.



To avoid that a wrong device configuration is restored:

- ▶ Check before the import if the required device configuration is saved on the SD card (identification of the saved device configuration: → **Export device configuration** (→ S. [76](#))).
- ▶ Save only the device configuration to be imported in the root directory of the SD card.

To transfer a stored device configuration to the device:

1 Reboot the device

- ▶ Insert the SD card containing the stored device configuration into the SD card slot.
- ▶ Disconnect and the device from the power supply and reconnect it to the power supply.
- > Device reboots.

2 Select menu page



- ▶ Select **[Configuration]** tab.

3 Restore the device configuration

- ▶ Activate the **[Import configuration]** button.
- > A warning appears.
- ▶ Confirm prompt with [OK].
- > The device configuration is loaded and saved onto the device.
- > The device reboots.

System reset

41704

To reset the device:

1 Select the menu page



- ▶ Select **Reset** tab.

2 Carry out a system reset

- ▶ Press **Restart** button.
- > A safety query is displayed..
- ▶ Press [OK] to confirm the security prompt.
- > The device reboots.

Store diagnostic protocol

41710

Using the diagnostic protocol, the user can archive the current device configuration or provide all relevant information to the service staff via the device settings.

The diagnostic protocol contains the following information in the selected user language:

- AS-i configuration
- PROFINET configuration
- System settings
- CODESYS information
- OSC history



This function is only available via the web-interface of the device (→ **Remote access** (→ S. [32](#))).

Requirements:

- ▶ Connect the device with PC/laptop (→ **Configuration interfaces: Connection concepts** (→ S. [115](#))).
- ▶ Start the web browser and open the web interface of the device (→ **Recommended browsers** (→ S. [32](#))).

1 Select menu page



- ▶ Select the [Diagnostic protocol] tab.

2 Store diagnostic protocol

- ▶ Press the [Generate diagnostic protocol] button.
- > AC1403/04 generates diagnostic protocol.
- > The progress bar indicates the status of the process.
- > A dialogue window appears.
- ▶ Select file name and memory location and press [OK] to confirm.
- > The diagnostic protocol is stored as an HTML file at the selected location.

5.5.4 System: Diagnosis

9053:

The [Diagnosis] menu item provides access to the diagnostic data of the device.

Display diagnostic data

41435

To display the diagnostic data of the device:

1 Select menu page



2 Display diagnostic data

> Page shows the following information:

Name	Description	Possible values	
[Betriebszeit [JJ-TTT SS:MM]]	Operating time of system and components	All times indicated in [JJ-TTT-SS-MM] format: YY = years DD = days hh = hours mm = minutes	
▪ [gesamt]	Operating time of device		
▪ [aktuell]	Operating time of device since last system start		
▪ [LCD]	Operating time of LCD		
▪ [SPS]	Operating time of controller		
[Temperatur]	Current device temperature	Indications in [°C] (→ Note)	
[Versorgt durch]	Voltage supply of device	[Aux]	Voltage is supplied separately by AS-i network and AUX 24 V.
		[AS-i]	Voltage is only supplied by the AS-i network.
		[Power Modul]	Voltage is supplied by data decoupling module.



The temperature monitoring continuously checks the system temperature of the device. The following temperature ranges apply:

- Normal range: < 79.9 °C
- Limit range: 80 °C ... 84.9 °C
- Critical range: >= 85 °C

If the system temperature reaches the critical zone, a warning is displayed in the → **Online Support Center (OSC)** (→ S. [108](#)). The warning only disappears when the device temperature is again in the normal range.

5.6 Interfaces

42920

The [Schnittstellen] menu provides access to the configuration options of the device's interfaces.

Navigation path	Functions
The navigation path consists of a PLC icon followed by a right-pointing chevron, then a computer monitor icon with the number '1' overlaid on it.	Configuration interface 1 → Configure the IP parameters manually (→ S. 82) → Configure the IP parameters automatically (→ S. 82) → Show Ethernet information (→ S. 83)
The navigation path consists of a PLC icon followed by a right-pointing chevron, then a computer monitor icon with the number '2' overlaid on it.	Configuration interface 2 → Interfaces: Configuration interface 2 (→ S. 83)
The navigation path consists of a PLC icon followed by a right-pointing chevron, then a Profinet icon (a green grid of dots).	PROFINET interface → Interfaces: PROFINET interface (→ S. 84)

5.6.1 Interfaces: Konfigurationsschnittstelle 1

41481

The [Konfigurationsschnittstelle 1] menu provides access to the settings of the Ethernet Konfigurationsschnittstelle 1 (port X3).

Notes on IP settings

41751

The device provides the following options for configuration of the Ethernet Konfigurationsschnittstelle 1:

- Manual = The operator sets the interface parameters (IP address, network mask, gateway address) manually.
- Automatic = The interface parameters are set automatically. The operator can choose between these protocols:
 - Dynamic Host Configuration Protocol (DHCP)
 - Zero Configuration Networking (Zeroconf)

To display the current configuration method and the active IP parameters of the configuration interface:

1 Select the menu page



- ▶ Select [IP setup] tab.

2 Show the active settings

- > The parameters below show the active settings:

Parameter	Meaning	Possible values	
[Obtain IP address autom.]	Active method for the configuration of the interface parameters	<input type="checkbox"/>	Manual assignment of interface parameters through operator
		<input checked="" type="checkbox"/>	Automatic assignment of interface parameters
[IP status]	Configuration protocol used	[Static]	The operator sets the IP parameters manually.
		[DHCP]	The IP parameters are set by a DHCP server.
		[Zeroconf]	The IP parameters are set automatically with the Zeroconf protocol.
[IP address]	IP address of the interface	e.g. 192.168.0.100	
[Subnet mask]	Network mask of the network segment	e.g. 255.255.255.0	
[Gateway address]	IP address of the network gateway	e.g. 192.168.0.1	

- ▶ Select one of the following options:
 - **Configure the IP parameters manually** (→ S. [82](#))
 - **Configure the IP parameters automatically** (→ S. [82](#))

Configure the IP parameters manually

To configure the IP parameters of the configuration interface manually:

1 Select the menu page



- ▶ Select [IP setup] tab.

2 Deactivate the NTP client

- ▶ Uncheck [Obtain IP address autom.] (→ **Notes on IP settings** (→ S. 81)).
- > The IP address fields [IP address], [Subnet mask] and [Gateway address] can be edited.

3 Configure the IP parameters

- ▶ Configure the following parameters as required (→ **Notes on IP settings** (→ S. 81)):
 - [IP address]
 - [Subnet mask]
 - [Gateway address]

4 Save the changes

- ▶ Press [Accept] button.
- > Selected values are applied.
- > [IP status] displays the active configuration method: [Static]

Configure the IP parameters automatically



The device must be connected to a DHCP server to automatically receive the interface parameters via DHCP.

- ▶ Connect the configuration interface (X3) to a DHCP server.

To configure the IP parameters of the configuration interface automatically:

1 Select the menu page



- ▶ Select [IP setup] tab.

2 Enable the NTP client

- ▶ Activate the [Obtain IP address autom.] (→ **Notes on IP settings** (→ S. 81))

3 Save the changes

- ▶ Press [Accept] button.
- > The device tries to obtain the IP parameters from a DHCP server.
- > If the configuration of IP parameters via DHCP server fails, the device will generate the IP parameters with the Zeroconf protocol.
- > [IP address], [Subnet mask] and [Gateway address] display the set IP parameters.
- > Selected values are applied.
- > [IP status] displays the active configuration method: DHCP or Zeroconf.



The automatic configuration of the IP parameters takes approx. 10 seconds.

Show Ethernet information

41660

To show Ethernet information regarding the configuration interface:

1 Select the menu page



- ▶ Select **Ethernet information** tab.

2 Show Ethernet information

- > Page shows the following information:

Name	Description
[MAC ID]	MAC identification number of the interface

5.6.2 Interfaces: Configuration interface 2

42105

The [Konfigurationsschnittstelle 2] menu provides access to the settings of the Ethernet configuration interface 2 (port X2).



The Ethernet configuration interfaces 1 (X3) and 2 (X8) must not be participants of the same EtherNet subnet. Non-compliance may lead to connection problems under CODESYS.

- ▶ Configure IP settings so that interfaces X3 and X8 are part of different Ethernet subnets.





The menu functions correspond to the functions of the menu [Konfigurationsschnittstelle 1]. For information regarding the menu functions: → **Interfaces: Konfigurationsschnittstelle 1** (→ S. [81](#))

- ▶ For the selection of the menu page replace the symbol  by !

5.6.3 Interfaces: PROFINET interface

41486

The [PROFINET] menu provides access to information, settings and diagnostic data regarding the PROFINET interface.

Navigation path	Functions
	PROFINET information → Display I&M information (→ S. 85) → Display PROFINET data (→ S. 86) → Display module configuration (→ S. 87) → Download GSDML file (→ S. 87)
	PROFINET settings → PROFINET interface (→ S. 88)
	PROFINET diagnosis → Display diagnostic data (→ S. 89)

PROFINET: Information

41553

The menu item [Information] provides access to information regarding the PROFINET interface.

Display I&M information

41441

To display the I&M information (I&M = Identification & Maintenance):

1 Select menu page

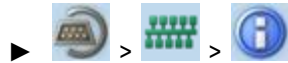

- ▶ Select **[I&M information]** tab.

2 Display I&M information

- > Page shows the following information:

Designation	Description
[Manufacturer ID]	Manufacturer ID
[Order number]	Article no. of the device
[SN]	Serial number of the device
[HW version]	Hardware version of the unit
[SW version]	Firmware version of the unit
[Revision no.]	Revision number of the unit
[Profile ID]	ID of the device profile
[Profile type]	Type of the device profile
[I&M version]	Version of the I&M data

Display PROFINET data

In order to display the PROFINET parameters and the device-specific parameters:

1 Select menu page

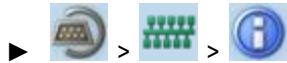

- ▶ Select [Profinet data] tab.

2 Display PROFINET data

- > Page shows the following information:

Designation	Description	Possible values	
[Device information]	Parameters of the PROFINET-device		
▪ [MAC ID]	MAC-ID of the device	e.g. 00:02:01:01:98:D4	
▪ [Device name]	Name of the device		
▪ [IP address]	IP address of the PROFINET-Interface	e.g.	
▪ [Device type]	type of the device	e.g. asi-pn	
[Host information]	Parameters of the PROFINET-Controller (host)		
▪ [IP address]	IP address of the PROFINET-Controller	e.g. 192.168.10.1	
▪ [Host name]	Designation of the PROFINET-Controller		
[Analog. channels/I-slave]	Number of analogue channels per projected input slave	[Unknown]	Device is not connected to the fieldbus master
		[1 channel]	1 channel per single slave OR: 1 channel per A slave
		[2 channels]	2 channels per single slave OR: 2 channels per A slave
		[4 channels]	4 channels per single slave OR: 2 channels per A/B slave
[Analog. channels/O-slave]	Number of analogue channels per projected output slave	→ [Analog. channels/I-slave]	
[Failsafe state]	Behaviour of the AS-i outputs in case of a PROFINET-connection interruption	[Reset outputs]	Outputs are reset to the preset values
		[Hold outputs]	Outputs hold the values which were available immediately before interruption of the connection.
[Parameter download]	Transmission of the AS-i slave parameters when establishing a PROFINET-connection	<input type="checkbox"/>	Parameters are not downloaded, i.e. AS-i slaves are activated with the parameters set on the device
		<input checked="" type="checkbox"/>	Parameters are downloaded, i.e. when the connection is established, the AS-i slave parameters set in the projecting software are PROFINET-downloaded by the controller to the device.
[Profinet alarms]	Transmission of the PROFINET-alarms	<input type="checkbox"/>	No transmission of PROFINET-alarms when errors occur in the gateway
		<input checked="" type="checkbox"/>	Transmission of PROFINET-alarms when errors occur in the gateway
[Swap IO]	Swap of assignment of the slave nibbles in the byte	<input type="checkbox"/>	Assignment of the slave nibble remains constant

Designation	Description	Possible values
		 Assignment of the slave nibble is swapped



Detailed information on the device-specific parameters: → **Parameter data** (→ S. [132](#))

Display module configuration

41444

To display the active configuration of the PROFINET-modules:

1 Select menu page

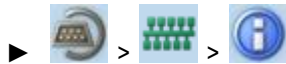

- ▶ Select **[Module configuration]** tab.

2 Display module configuration

- > Page shows active module configuration of the PROFINET-Slots (→ appendix).



The fieldbus slots can only be configured in the PROFINET-projection software.

Download GSDML file

41501



This function is only available via the web-interface of the device (→ **Remote access** (→ S. [32](#))).

Requirements:

- ▶ Connect the device with PC/laptop (→ **Configuration interfaces: Connection concepts** (→ S. [115](#))).
- ▶ Start the web browser and open the web interface of the device (→ **Recommended browsers** (→ S. [32](#))).

1 Select menu page



- ▶ Select **[GSDML file]** tab.
- > Menu page **[GSDML file]** is displayed.

2 Download GSDML file

- ▶ Mouse-click on **[Download GSDML file]** to download the device description.

PROFINET: Setup

41552

The [Setup] menu item provides access to the configuration options of the PROFINET interface.

PROFINET interface

42064



We recommend installing the fieldbus on the PROFINET-controller and to adopt the configuration on the device.

In order to PROFINET-configure the interface:

1 Select menu page

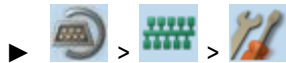

2 Set IP parameters of the PROFINET-interface

► Set the following parameters as required:

Parameters	Description	Possible values
[IP address]	IP address of the PROFINET-interface	e.g. 192.168.10.3
[Subnet mask]	Netmask of the PROFINET-network segment	e.g. 255.255.255.0
[Gateway address]	IP address of the PROFINET-Gateways	e.g. 192.169.10.1

3 Save changes

- Press [Accept] button .
- > Selected values are applied.

PROFINET: Diagnosis

41554

The menu item [Diagnosis] provides access to the diagnostic data of the PROFINET interface:

Display diagnostic data

41443

In order to PROFINET-display the diagnostic data:

1 Select menu page

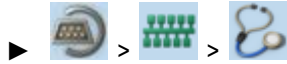

2 Display diagnostic data

> Page shows the following information:

Name	Description	Possible values	
[PROFINET connection status]	Display of the connection status of the PROFINET-interfaces		
▪ [Status port X6]	Connection status port X6		No connection to the PROFINET-controller
			Connection to the PROFINET-controller established
▪ [Status port X7]	Connection status port X7		No connection to the PROFINET-controller
			Connection to the PROFINET-controller established

5.7 ifm system solutions

41480



This menu is only available via the web interface of AC1403/04.
→ **Remote access** (→ S. [32](#))

The [ifm system solutions] menu provides access to information and installation options for ifm system solutions.

Navigation path	Functions
	ifm system solutions: → Show information about installed ifm apps (→ S. 92) → Install single/basic app (→ S. 93) → Install multi app (→ S. 94) → Update ifm apps (→ S. 95) → Uninstall ifm apps (→ S. 95)

5.7.1 Notes on ifm system solutions

41753

With the AC1403/04, ifm electronic offers different system solutions for the simple implementation of typical applications. System solutions consist of applications which are processed by the device-internal CODESYS SPS.



ifm system solutions and user-created Anwendungen must not be stored and run simultaneously on the AC1403/04!

- ▶ Delete all CODESYS system solutions stored on the device before installing new ifm system solutions or user applications!

ifm system solutions can only be installed and run if the device-internal SPS is activated.

- ▶ Activate the SPS of the AC1403/04 (→ **Enable/Disable the device-internal PLC** (→ S. [67](#)))!



Users can download the available ifm system solutions from ifm's website.

Types of ifm system solutions

41684

There are 2 types of ifm system solutions:

- **Single apps**
Single apps provide the user with a CODESYS-based solution. Single apps directly access the I/O mechanisms of the CODESYS SPS. Only one single app must be stored and executed on the device.
- **Basic app + multi apps**
Multi apps provide the user with the possibility to execute different CODESYS-based solutions in parallel. The multi apps use the services of the basic app in order to be able to access the inputs and outputs of AC1403/04 at the same time. They operate as a pure communication layer between the I/O mechanisms of the CODESYS SPS and the connected multi apps. Maximum 5 multi apps at a time can be stored and executed in parallel on the device.

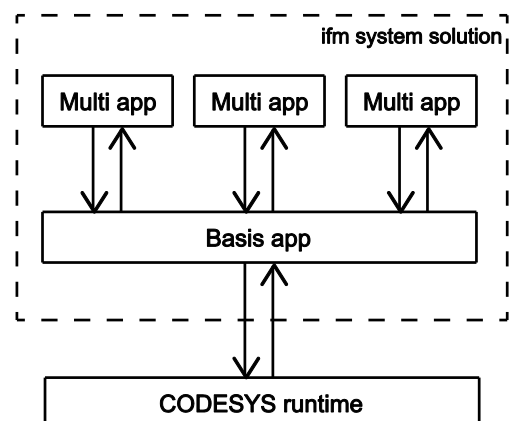
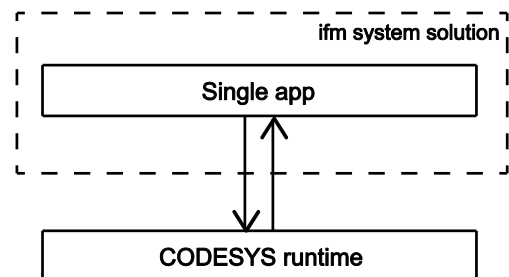

5.7.2 Show information about installed ifm apps

41658

In order to display information about the ifm system solutions installed on the device:

1 Select menu page



- ▶ Select the [Information] tab.

2 Show information about installed ifm apps

- > The browser window displays an overview of the installed ifm apps. The following information is displayed for each ifm app:

Information	Meaning
[Name]	Designation of the ifm system solution app
[Version]	Version number of the ifm system solution app
[Type]	Type of ifm app (single, basic, multi)
[Description]	Description of the functionality of the ifm system solution app
[Licence information]	Licence information about the ifm system solution in the selected user language
[Link to the ifm system solution app]	Hyperlink for web visualisation of the ifm system solution app

5.7.3 Install single/basic app



Only one single app, basic app or CODESYS SPS application must be stored on the device. When installing a single/basic app, all ifm system solutions and CODESYS SPS applications stored on the device are deleted.

To install a single or basic app on the device:

1 Select menu page



- ▶ Select the [Installation] tab.

2 Select single/basic app

- ▶ Activate the [Search] button.
- > A dialogue window appears.
- ▶ Select the requested single/basic app (*.ifmapp) and click [Open] to load it.
- > The file name of the selected single/basic app is displayed.

3 Transfer the single/basic app to the device

- ▶ Click on [Transfer file] button to transfer the selected single/basic app to the device.
- > The progress bar indicates the status of the process.
- > After successful transfer: The window shows information about the copied single/basic app.
- ▶ Optional: Click on [Cancel] to stop the download process.

4 Install the single/basic app

- ▶ Activate the [Start installation] button.
- > CODESYS SPS is stopped.
- > All ifm system solutions and CODESYS SPS applications on the device are deleted.
- > The selected single/basic app is installed.
- > The progress bar indicates the status of the installation process.
- > CODESYS SPS is started.
- > The installed single/basic app is automatically started (RUN state).

5.7.4 Install multi app



Maximum 5 multi apps must be stored on the device simultaneously.

To install a multi app on the device:

Requirements:

- > The basic app is installed and started (RUN state) (→ **Install single/basic app** (→ S. [93](#)))

1 Select menu page



- ▶ Select the [Installation] tab.

2 Select multi app

- ▶ Activate the [Search] button.
- > A dialogue window appears.
- ▶ Select the requested multi app (*.ifmapp) and click the [Open] button to load it.
- > The file name of the selected multi app is displayed.

3 Transfer the multi app onto the device

- ▶ Click on [Transfer file] to transfer the selected multi app onto the device.
- > The progress bar indicates the status of the process.
- > After successful transfer: The window shows information about the copied multi app.
- ▶ Optional: Click on [Cancel] to stop the download process.

4 Install multi app

- ▶ Activate the [Start installation] button.
- > CODESYS SPS is stopped.
- > The selected multi app is installed.
- > The progress bar indicates the status of the installation process.
- > CODESYS SPS is started.
- > The installed multi app is automatically started (RUN state).
- ▶ Optional: Repeat steps 2 to 4 to install further multi apps.

5.7.5 Update ifm apps

41682

The user can update an ifm system solution installed on the device by overwriting it with the new version of the ifm system solution.

Naming convention for ifm apps:

AppName_x.y.z.ifmapp

AppName =	name of the ifm app
x.y.z =	version number of the ifm app
ifmapp =	file extension of an ifm app

To update an ifm system solution:

Requirements:

- > The name of the new ifm app and the installed ifm app must be identical.
- > The version number of the ifm app must be greater than that of the installed ifm app.



To determine the version of the installed ifm app: → **Show information about installed ifm apps** (→ S. [92](#))

1 Download new ifm app

- ▶ Download new version of the ifm system solution (→ **Notes on ifm system solutions** (→ S. [91](#))).

2 Update the installed ifm app

- ▶ Install the new ifm system solution
 - Single/basic app: → **Install single/basic app** (→ S. [93](#))
 - multi app: → **Install multi app** (→ S. [94](#))

5.7.6 Uninstall ifm apps

41683



When a basic app is uninstalled, all dependent multi apps are uninstalled, too.

Before uninstalling an ifm app, the CODESYS SPS of AC1403/04 is stopped. After successful uninstallation, the CODESYS SPS is started again.

To uninstall an ifm system solution installed on the device:

1 Display installed ifm apps

- ▶ **Show information about installed ifm apps** (→ S. [92](#))

2 Uninstall ifm app

- ▶ In the section of the respective ifm app:
 - Activate the [Uninstall app] button.
- > CODESYS SPS is stopped.
- > The selected ifm app is uninstalled.
- > CODESYS SPS is started.

6 Setup

Content

Connect the device to the periphery.....	96
Start screen 'Basic settings'.....	97
Update the firmware of the device.....	99
Connect and address AS-i slaves	103
Set up Profinet.....	103
Set Ethernet configuration interfaces	104
Exchange AS-i slave	104

41644

This section provides information for setting up the device following mounting, electrical installation and connection to AS-i network components.



Observe the notes on mounting and electrical connection of the device!
→ Operating instructions (supplied with the device)

6.1 Connect the device to the periphery

41574

6.1.1 EtherNet/IP interface

41494

To connect the device to a PROFINET network:

- ▶ Integrate the device into the PROFINET network via the X6 and/or X7 EtherNet ports according to the requested topology.
Details → **Interfaces** (→ S. [13](#))

6.1.2 Configuration interface

41596

To access the device via the configuration interface (e.g. web interface, programming interface of the device-internal CODESYS PLC):

- ▶ connect the configuration interface (X3) of the device to the programming PC/laptop directly or via an Ethernet network.
Details: → **Configuration interfaces: Connection concepts** (→ S. [115](#))

6.2 zzStart screen 'Basic settings'

41689

The 'Basic settings' start screen appears after the following actions/events:

- initial setup
- firmware update
- data loss due to battery failure

The basic settings provide access to the GUI texts, system time, etc.



The same operating notes as for the page view apply for the 'Basic settings' start screen (→ **Page view** (→ S. [19](#))).

6.2.1 Change the basic settings of the device

41597

To change the basic settings of the device:

1 Start the device

- ▶ Connect the device to a circuit.
- > The device starts.
- > The display shows the start screen "Basic settings" (screenshot).

2 Set the language of the GUI texts

- ▶ List shows the active language.
- ▶ Use [▼] / [▲] to mark the list.
- > The focus (= orange frame) is on the marked list.
- ▶ Open the list with the left function key [Select].
- ▶ Use [▼] / [▲] to mark the desired language and press [Select] to activate it.
- > The GUI texts appear in the selected language.
- ▶ Go to the next page with [\[Next\]](#).

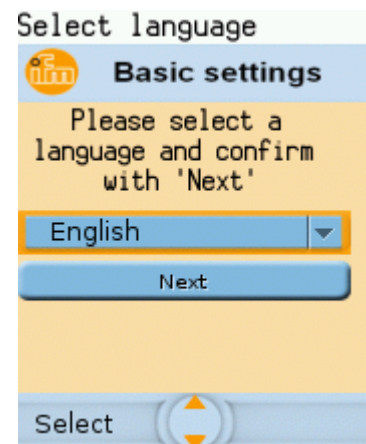

3 Set the system time

Option 1: Set the system time manually

- ▶ [Uhrzeit] and [Datum] indicate the current system time.
- ▶ Deactivate the checkbox [NT aktivieren].
- > Status LED =
- ▶ In the group [Uhrzeit], set the desired clock time one position at a time.
- ▶ In the group [Datum], set the desired date one position at a time.
- ▶ Save the changes with [Finish] and go to the standard start screen.

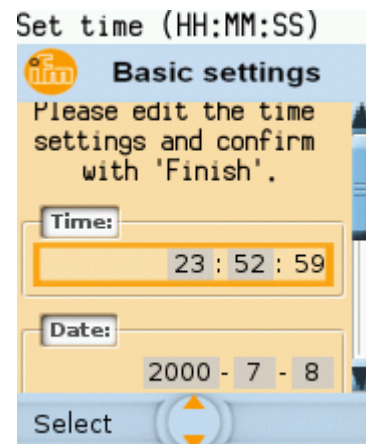

Option 2. Synchronise the system time with an NTP server

- ▶ Activate the checkbox [NTP aktivieren].
- > Status LED =
- ▶ Enter the IP address of the NTP server in the IP address field.
- ▶ Pick the time zone of the NTP server from the list (UTC format).
- > The NTP client of the device synchronises the system time with the selected NTP server.
- ▶ Wait until status LED =
- > [Datum] and [Uhrzeit] show the synchronised values.
- ▶ Save the changes with [Finish] and go to the standard start screen.

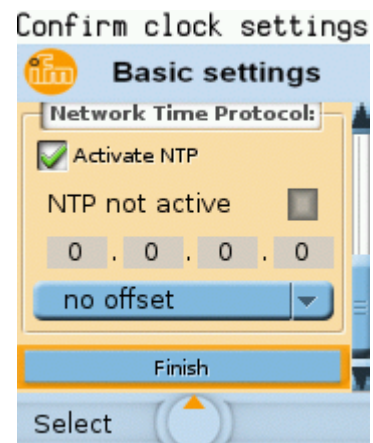

6.3 Update the firmware of the device

NOTICE!

Interrupting a firmware update leads to a loss of the current system and fieldbus settings.

- > Risk of data loss!
- ▶ Secure the device settings before carrying out a firmware update! (→ **Export device configuration** (→ S. [76](#)))
- ▶ Ensure an uninterrupted voltage supply during the firmware update!

To update the firmware of the device:

- ▶ Select one of the following options:
 - **Firmware update from SD card** (→ S. [100](#))
 - **Firmware update via the web interface** (→ S. [101](#))

6.3.1 Behaviour of the settings upon firmware update

The following settings/data records remain valid upon a firmware update:

Setting / data record	Path to the menu page
User language of the GUI	[System] > [Setup] > [System settings]
Display settings (screen saver, return)	[System] > [Setup] > [System settings]
System time (date/time)	[System] > [Setup] > [Clock]
NTP settings	[System] > [Setup] > [Clock]
Operating hours counter	[System] > [Diagnosis]
AS-i master settings and configuration data	[AS-i 1] / [AS-i 2] > [Master setup]
IP parameters of the configuration interface	[Interfaces] > [Configuration interface] > [IP-Setup]
Fieldbus settings	[Interfaces] > [PROFINET] > [Setup]

The following settings/data records are reinitialised with their default values upon firmware update:

Setting / data record	Reset value	Path to the menu page
Control of the outputs	Gateway	[System] > [Setup] > [System settings]
Activate CODESYS PLC	deactivated	[System] > [Setup] > [System settings]
Device cycle	0.7 ms	[System] > [Setup] > [System settings]
OSC	Delete system messages	Start page > [OSC]
Retain variables	0x00	--

6.3.2 Firmware update from SD card



Pay attention to notes on memory behaviour (→ **Behaviour of the settings upon firmware update** (→ S. [99](#)))!

1 Preparations

- ▶ Download the new firmware file from the **ifm** website.
- ▶ Copy the firmware file into the root directory of an SD card.
- ▶ Insert the SD card containing the firmware file in the SD card slot (→ **SD card slot** (→ S. [13](#))).

2 Start the recovery mode

- ▶ Separate the device from the circuit.
- ▶ Perform the following actions simultaneously:
 - Press the left function key and the arrow keys [**▲**] and [**▼**] simultaneously and keep them pressed (→ picture).
 - Connect the device to a circuit.
- ▶ Keep the keys pressed until the screen [ifm Recovery] appears (approx. 10 s).



3 Update the firmware

- ▶ Use the arrow keys [**▲**] / [**▼**] to select the menu item [Install from SD] (→ picture).
- ▶ Press [OK] using the left function key.
- > The updating process starts.
- > The display shows the progress of the firmware update.
- > A status message appears once the firmware has been updated successfully.

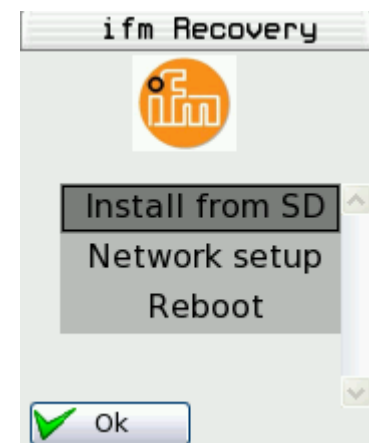

4 Reboot the device

- ▶ Use the arrow keys [**▲**] / [**▼**] to select the [Reboot] button.
- ▶ Press [OK] to reboot the device.
- > The device reboots with the current firmware.
- > The start screen "Basic settings" appears (→ **Start screen 'Basic settings'** (→ S. [97](#))).

6.3.3 Firmware update via the web interface



Pay attention to notes on memory behaviour (→ **Behaviour of the settings upon firmware update** (→ S. [99](#)))!

1 Preparations

- ▶ Download the new firmware file from the **ifm** website.
- ▶ Connect the PC/laptop to the configuration interface (X3) of the device.
(→ **Configuration interfaces: Connection concepts** (→ S. [115](#)))

2 Start the recovery mode

- ▶ Separate the device from the circuit.
- ▶ Perform the following actions simultaneously:
 - Press the left function key and the arrow keys [▲] and [▼] simultaneously and keep them pressed (→ picture).
 - Connect the device to a circuit.
- ▶ Keep the keys pressed until the screen [ifm Recovery] appears (approx. 10 s).



3 Optional: adjust the IP parameters

- ▶ Use the arrow keys [▲] / [▼] to select the menu item [Network Setup].
- ▶ Press [OK] to go to the network setup.
- > The display shows the page [Network Setup] (→ picture).
- > The page shows the current IP address of the device.

Option 1: obtain the IP parameters from a DHCP server

- ▶ Connect the configuration interface to the DHCP server.
- ▶ Use the arrow keys [▲] / [▼] to select the menu item [DHCP].
- ▶ Press [OK] to activate the DHCP client of the device.
- > The device obtains the IP parameters from the DHCP server.
- > If not successful, the device will create the IP parameters by means of the Zeroconf protocol.
- > The display shows the [Network Setup] page with the new IP address.
- ▶ Leave the network setup with [Back].
- > The display shows the [ifm Recovery] page.

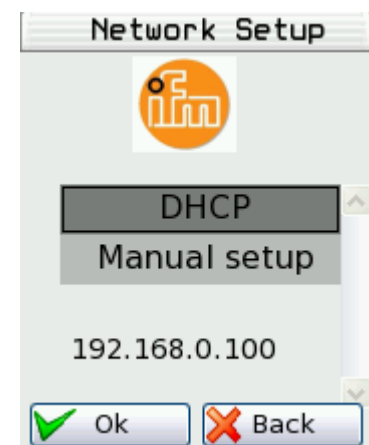

Option 2: configure the IP parameters manually

- ▶ Use the arrow keys [▲] / [▼] to select the menu item [Manual Setup].
- ▶ Activate the manual setup with [OK].
- > The display shows the [Static IP setup] page (→ picture)
- ▶ Use the arrow keys [▲] / [▼] to select the following menu items one after the other and set them as required:
 - [IP Address]
 - [Network Mask]
 - [Default gateway]
- ▶ Press [Apply] to save the set values.
- > The display shows the [Network Setup] page with the new IP address.
- ▶ Leave the network setup with [Back].
- > The display shows the [ifm Recovery] page.

**4 Update the firmware**

- ▶ Access the web interface of the device.
- > The web interface of the recovery mode appears:



- ▶ Press the [Search ...] button.
- > The file explorer appears.
- ▶ Select the firmware file and press [Open].
- > The field [Select image to upload] shows the file path and name of the firmware file.
- ▶ Press [send] to start the updating process.
- > The display and web interface show the progress of the firmware update.
- > A status message appears once the firmware has been updated successfully.

5 Reboot the device

- ▶ Click on the tab [Reboot]
- > The device reboots with the current firmware.
- > The start screen "Basic settings" appears (→ **Start screen 'Basic settings'** (→ S. 97)).

6.4 Connect and address AS-i slaves

To integrate AS-i slaves into an AS-i network that is controlled by one of the AS-i masters of the device:

1 Connect and address the AS-i slave

- ▶ Connect ONE AS-i slave to be addressed to the requested AS-i network (AS-i 1 or AS-i 2) as described in the corresponding installation instructions.
- ▶ Assign the desired address to the AS-i slave
(→ **Quick setup: Address the AS-i slaves connected to AS-i Master 1** (→ S. 45) or → **Quick setup: Address the AS-i slaves connected to AS-i Master 2** (→ S. 46)).
- ▶ Optional: Repeat step 1 to connect and address further AS-i slaves.

2 Project the AS-i network

- ▶ Carry out a projection adaptation on the AS-i master with the newly addressed AS-i slaves
(→ **Quick setup: Project AS-i networks** (→ S. 39)).
- > The AS-i master adds the detected slaves (LDS) to the list of the projected slaves (LPS).
- > The AS-i slaves have a valid address and are integrated in the AS-i network.

6.5 Set up Profinet



Detailed information on the configuration of the PROFINET-network: → Operating instructions of the PROFINET-master

To integrate the device into a PROFINET-network:

1 Set interface parameters



- ▶ Set interface parameters (→ **PROFINET interface** (→ S. 88)).

2 Integrate the device with a GSDML file into a PROFINET-project

- ▶ Copy GSDML file of the device on PC/laptop with the PROFINET-configuration software (→ **Download GSDML file** (→ S. 87)).
- ▶ Load the device with the GSDML file into the device library of the PROFINET-configuration software (→ operating instructions of the PROFINET-configuration software).
- ▶ Integrate the device into the PROFINET-project.

3 Set device parameters, fieldbus modules and system behaviour

- ▶ Set the following parameters in the PROFINET-configuration software:
 - Device-specific parameters (→ **Parameter data** (→ S. 132))
 - PROFINET-Modules (→ **PROFINET modules** (→ S. 135))
- ▶ Set the system behaviour in the PROFINET-configuration software (e.g. watchdog)

4 Configuration activate

- ▶ Store configuration and load to the PROFINETController (download).
- ▶ PROFINET-Start controller.
- > The device is integrated into the PROFINET-network (→ status LED of the PROFINET-interface)

5 Select



- ▶ Select the **Profinet data** tab.
- > Page shows the stored configuration.

6.6 Set Ethernet configuration interfaces

To configure the Ethernet configuration interfaces 1 (X3) and 2 (X8):

- Ethernet configuration interface 1 (X3):



- ▶ Select **[IP setup]**.
- ▶ Set interface parameters (→ **Notes on IP settings** (→ S. [81](#))).

- Ethernet configuration interface 2 (X8):



- ▶ Select **[IP setup]**.
- ▶ Set interface parameters (→ **Notes on IP settings** (→ S. [81](#))).

6.7 Exchange AS-i slave

AC1403/04 makes it possible to replace an AS-i slave by a new AS-i slave in the operating mode "protected mode".

Requirements:

- > The new and the old AS-i slave have the same device profile (→ **Profiles of AS-i slaves** (→ S. [122](#))).
- > The new AS-i slave has the address 0.
- > Parameter [Automat. addressing] is activated (→ **Set the monitoring functions of the AS-i master** (→ S. [49](#))).

1 Remove old AS-i slave

- ▶ Disconnect the AS-i slave to be replaced from the AS-i network
- > AC1403/04 detects a configuration error and generates a corresponding OSC message.

2 Install new AS-i slave

- ▶ Connect the new AS-i slave to the AS-i network.
- > AC1403/04 detects the new AS-i slave and automatically assigns the address of the old AS-i slave.
- > The OSC error message disappears.
- > The new AS-i slave is operational.

7 Troubleshooting

Content

Status LED	105
Start screen: Status LEDs	106
Online diagnosis function	107
Online Support Center (OSC)	108

41667

This chapter offers information regarding fault detection and troubleshooting.

7.1 Status LED

41692

The status LEDs of the device provide information about the current state of system components.



Position of the status LED on device: → **Overview** (→ S. [11](#))

7.1.1 Status LED: Basic device

41691

Status LED			Description
H1	green	on	Device has started, warnings or error messages.
	yellow	flashes 0.5 Hz	There is a warning but not an error message.
	red	flashes 2 Hz	There is an error message.

7.1.2 Status LED: Fieldbus PROFINET

41708

Status LED			Description
H2	yellow	off	no data transmission
		flashes	Reception of data
H3	green	off	no physical connection
		on	Physical connection OK
H4	yellow	off	no data transmission
		flashes	Reception of data
H5	green	off	no physical connection
		on	Physical connection OK

7.2 Start screen: Status LEDs

41688

The start screen of the graphic user interface provides the following status information (→ **Start screen** (→ S. [36](#))):

7.2.1 Status of the web interface

41707

Status LED			Description
Web interface status	red	on	offline
	green	on	online



This function is only available via the web interface of the device (→ **Remote access** (→ S. [32](#))).

7.2.2 Operating mode of the AS-i master

41722

Status LED			Description
AS-i 1 2 operating mode	yellow	on	projection mode
	green	on	protected mode

7.2.3 Control instance of the AS-i outputs

41569

Status LED			Description
Output control	yellow	on	manually manually via PLC
	green	on	gateway gateway with PLC
	blue	on	PLC

7.2.4 Fieldbus status

41417

Status LED			Meaning
PROFINET	red	on	PROFINET inactive
	green	on	PROFINET active

7.3 Online diagnosis function



41719

The device offers an online diagnosis function. It helps the user to find and eliminate the source of occurring failures and errors.

7.3.1 Message types

41754

The online diagnostic function of AC1403/04 distinguishes 3 types of messages:

Symbol	Message type	Meaning
	Error	<ul style="list-style-type: none"> An error occurred; proper operation of the device is disturbed. User action absolutely required
	Warning	<ul style="list-style-type: none"> An irregularity has occurred User action required
	Event	<ul style="list-style-type: none"> An uncritical event has occurred No user action required

7.3.2 Locate error sources

41743

The online diagnosis function helps the operator to locate the source of occurring warning and error messages. The menu symbols of the navigation path leading to the menu page, which generates a message, are overlain by a warning / error symbol. Thus, the operator can easily locate the error source.

Example:



- > The following menu symbols are overlain by an error symbol:
 - Main navigation bar: [AS-i 1]
 - Sub navigation bar: [Slaves]
- > Error source on menu page [AS-i 1] > [Slaves]



If a function unit of the device causes a warning and an error message at the same time, then the error symbol is displayed.

7.4 Online Support Center (OSC)

41718

The Online Support Center (OSC) displays detailed information about occurring events, failures and errors.

The OSC has the following appearance:

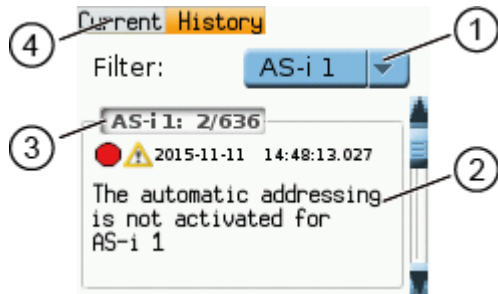

- ① List to select a filter and name of the selected filter
- ② Message
An message consists of error symbol, timestamp and detailed information about the errors
- ③ Number of the message displayed and total number of messages
- ④ Tabs to select a view
[Current]: → **OSC: View current error messages**
(→ S. [109](#))
[History]: → **OSC: Show message history** (→ S. [110](#))

7.4.1 OSC: View current error messages

The [Current] tab lists all current messages. The messages are in chronological order. All messages regarding warnings and errors are displayed.



Information about the different types of messages: → **Message types** (→ S. [107](#))
 Overview of possible OSC messages of the device: → **OSC messages** (→ S. [170](#))

To view the error messages that are currently active:

1 Select the menu page

- ▶ On the start screen: Select [OSC]
- ▶ Select **[Current]** tab.

2 Show current messages

- > The page shows the error messages that are currently active.
- ▶ Press [▼] to select the message field.
- > The focus (orange frame) is on the message field.
- ▶ Use [▲]/[▼] to go through the error messages.

3 Optional: filter messages

- ▶ Set the following parameters as required:

Parameter	Description	Possible values	
[Filter]	System component the message was created in	[All]	Display all messages in chronological order of their occurrence (= preset).
		[AS-i 1]	Display messages that were created in AS-i master 1.
		[AS-i 2]	Display messages that were created in AS-i master 2 (only selectable for devices with 2 AS-i masters).
		[System]	Display messages that were created in the system.

- > Page shows filtered messages.

7.4.2 OSC: Show message history

The [History] tab lists all messages which occurred during the operating time of the device. The messages are shown in chronological order. The device displays messages regarding events, warnings and errors.



The messages are stored in a ring buffer. The ring buffer can store 2000 messages. If full, the device overwrites the oldest message(s) (time stamp).

There is a message pair for each failure (warning, error). It indicates the time of occurrence of the failure and the time at which the cause of the failure was rectified. The symbols of the messages are correspondingly marked.

Example: Error message



Time at which the error occurred



Time at which the cause of the fault was rectified.

To display the history of messages created so far again:

1 Select menu page

- ▶ On the start screen: Select [OSC].
- ▶ Select [History] tab.

2 Display all messages

- > The page shows all previously generated error messages.
- ▶ Press [▼] to select the message field.
- > The focus (orange frame) is on the message field.
- ▶ Use [▲]/[▼] to go through the error messages.

3 Optional: Filter messages

- ▶ Set the following parameters as required:

Parameter	Description	Possible values	
[Filter]	System component the message was created in	[All]	Display all messages in chronological order of their occurrence (= preset).
		[AS-i 1]	Display messages that were created in AS-i master 1.
		[AS-i 2]	Display messages that were created in AS-i master 2 (only selectable for devices with 2 AS-i masters).
		[System]	Display messages that were created in the system.

- > Page shows filtered messages.

8 Appendix

Content

Approval tests / certifications	111
Technical data	112
Address assignment in Ethernet networks	114
Configuration interfaces: Connection concepts	115
AS-i master	117
AS-i slaves	121
Fieldbus Profinet	131
OSC messages	170

33879

8.1 Approval tests / certifications

41520

Software-relevant certifications:

- AS-i master profile M4 according to AS-i specification 3.0
- Fieldbus certification: Profinet class B

8.2 Technical data

Content

Housing.....	112
Power supply connections.....	112
Operation.....	112
Display elements.....	112
Interfaces.....	113
Programmable Logic Controller (PLC).....	113

34188

8.2.1 Housing

41477

Housing	
Degrees of protection	IP20
Material	Aluminium, steel sheet, Makrolon
Dimensions (W x H x D) [mm]	93 x 128,2 x 106,2

8.2.2 Power supply connections

41800

Power supply connections	
AS-i 1, AS-i 2, FE	plug-in, 6 poles, Combicon
24 V Power supply	plug-in, 2 poles, Combicon

8.2.3 Operation

41714

Membrane keys	
Function keys	2x
Navigation keys / arrow keys	4x

8.2.4 Display elements

41442

Display	
Technology	LCD, colour
Size	35 x 28 mm (1.8")
Resolution	220 x 176 pixels
Colour depth	18 bits (= 262 144 possible colours)

LED	
Possible colours	red, green, yellow

8.2.5 Interfaces

41491

EtherNet configuration interface	
Connection	2x RJ45
Transmission	10/100 Mbits/s
Protocol	HTTP, FTP, Telnet

41491

Ethernet fieldbus interface	
Connection	2x RJ45
Protocol	Profinet RT (device), class B
Transmission	10/100 Mbits/s
Switch	integrated 2-port switch (IRT compatible)

41491

SD card slot	
Media	SD memory cards (max. 32 Gbytes)
Format	SDHC format is supported
Supported file formats	FAT32

8.2.6 Programmable Logic Controller (PLC)

41770

Programmable Logic Controller (PLC)	
Type	CODESYS Control Runtime System (incl. CODESYS WebVisu)
Programming system	CODESYS Development System (version V3.5 SP9 Patch 7 Hotfix 3 or higher)
Programming languages	FBD, SFC, CFC, IL, LD, ST
Available memory for PLC applications / RETAIN variables	approx. 10 MB / 4072 bytes

8.3 Address assignment in Ethernet networks

39571



In the Ethernet network every IP address **MUST** be unique.

The following IP addresses are reserved for network-internal purposes and are therefore not allowed as an address for participants: nnn.nnn.nnn.0 | nnn.nnn.nnn.255.

Only network participants whose subnet mask is identical and whose IP addresses are identical with respect to the subnet mask can communicate with each other.

Rule:

If part of the subnet mask = 255, the corresponding IP address parts must be identical.

If part of the subnet mask = 0, the corresponding IP address parts must be different.

If the subnet mask = 255.255.255.0, 254 participants communicating with each other are possible in the network.

If the subnet mask = 255.255.0.0, 256x254 = 65 024 participants communicating with each other are possible in the network.

In the same physical network different subnet masks of the participants are allowed. They form different groups of participants which cannot communicate with groups of participants having other subnet masks.



In case of doubt or problems please contact your system administrator.

Examples:

Participant A IP address	Participant A Subnet mask	Participant B IP address	Participant B Subnet mask	Communication of participants possible?
192.168.82.247	255.255.255.0	192.168.82.10	255.255.255.0	Yes, 254 participants possible
192.168.82. 247	255.255.255.0	192.168.82. 247	255.255.255.0	No (same IP address)
192.168.82.247	255.255. 255 .0	192.168.82.10	255.255. 0 .0	No (different subnet mask)
192.168. 82 .247	255.255.255.0	192.168. 116 .10	255.255.255.0	No (different IP address range: 82 vs. 116)
192.168.222.213	255.255.0.0	192.168.222.123	255.255.0.0	Yes, 65 024 participants possible
192.168.111.213	255.255.0.0	192.168.222.123	255.255.0.0	Yes, 65 024 participants possible
192.168.82.247	255.255.255.0	192.168.82. 0	255.255.255.0	No; the whole network is disturbed because the IP address xxx.xxx.xxx.0 is not allowed

8.4 Configuration interfaces: Connection concepts

Content

Direct connection	115
Connection via Ethernet network	116

42146

The device has 2 configuration interfaces X3 and X8 (→ **Ethernet configuration interfaces** (→ S. 13)).

To use the interface functions configuration interface X3 or X8 has to be connected to the necessary IT infrastructure. The device supports the following connection types:

- **Direct connection** (→ S. 115)
- **Connection via Ethernet network** (→ S. 116)

8.4.1 Direct connection

42925

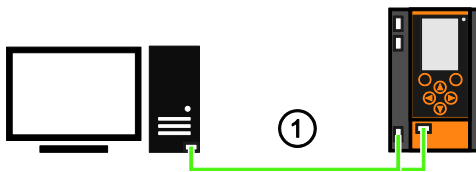

- ①
- ▶ Connect either configuration interface 1 (X3) or 2 (X8) to the PC/laptop via Ethernet cable.
 - ▶ Set the IP parameters of the configuration interface according to the requirements. (→ **Address assignment in Ethernet networks** (→ S. 114))
 - > User can access the web interface and/or programming interface of the device.



The selected configuration interface must not be used as EtherCAT master!

8.4.2 Connection via Ethernet network

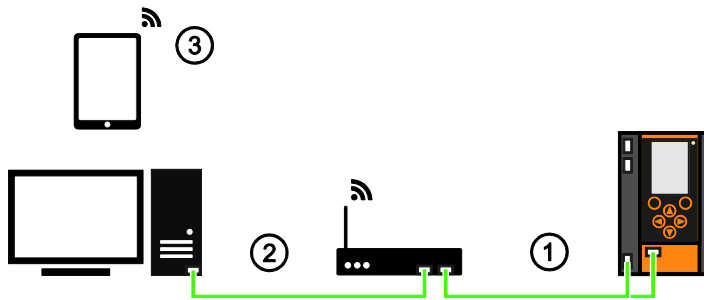

- ①
 - ▶ Connect either configuration interface 1 (X3) or 2 (X8) to switch / WiFi router via Ethernet cable.
 - ▶ Set IP parameters of the configuration interface and the switch / WiFi router so that the data exchange between both devices is ensured. (→ **Address assignment in Ethernet networks** (→ S. [114](#)))
- ②
 - ▶ Connect the PC/laptop to the switch using an Ethernet cable.
 - > User can access the web interface and/or programming interface of the device.

OR:
- ③
 - ▶ Establish wireless connection of PC/laptop/mobile device to the WiFi router.
 - > User can access the web interface and/or programming interface of the device.



The selected configuration interface must not be used as EtherCAT master!

8.5 AS-i master

Content

Operating modes of the AS-i master	118
Master flags	120

41540

Master = Handles the complete organisation on the bus. The master decides on the bus access time and polls the →slaves cyclically.

8.5.1 Operating modes of the AS-i master

Content

Protected mode	118
Projection mode.....	118
Switch operating modes	119

41721

The AS-i master can be operated in one of the following operating modes:

Protected mode

41761

In the operating mode "Protected mode" (= normal mode), the AS-i master only communicates with AS-i slaves that are entered in the list of projected slaves (LPS) and where current and target configuration match.

The AS-i master automatically detects the following actions and signals a configuration error:

- an AS-i slave is added to the AS-i network (error message: Slave not projected)
- an AS-i slave is removed from the AS-i network (error message: Slave not present)

Optionally, the operator can activate/deactivate the following monitoring functions (→ **Set the monitoring functions of the AS-i master** (→ S. [49](#))):

• Automatic addressing:	When a defective slave is replaced, the AS-i master controls the addressing. The new AS-i slave obtains the same address as the old AS-i slave if the following conditions are met: <ul style="list-style-type: none"> ▪ The new AS-i slave has the address 0. ▪ Both AS-i slaves have the same device profile.
• Double address recognition:	The AS-i master recognises whether one or several AS-i slaves have the same address (error message: Double address error).
• Earth-fault detection:	The AS-i master detects any earth faults.

In the operating mode "Protected mode", the operator can control the PLC applications stored on the device (start, stop, reset).

Projection mode

41762

In the operating mode "Projection mode", the AS-i master communicates with all AS-i slaves that are connected to the AS-i line and do not have the address 0. Missing AS-i slaves are not detected by the AS-i master.

In projection mode a projection adaptation can be carried out. The AS-i master reads the configuration data of all detected AS-i slaves and saves it permanently.

Switch operating modes

41702

The operator / programmer can switch the operating modes of the AS-i master as follows:

- per GUI / web interface (→ **Set the operating mode of the AS-i master** (→ S. [48](#)))
- per function block Set_Mode (→ programming manual: **Set_Mode**)



If an AS-i slave with the address 0 is connected, then the AS-i master cannot switch from "projection mode" into "protected mode" !

- ▶ Address the AS-i slave correctly.
- ▶ Switch the operating mode.

8.5.2 Master flags

41738

The master flags contain information about the status of the AS-i master and the fieldbus host.

The master flags are transmitted along with the input data of the digital AS-i slaves in the acyclic data set DS2 (→ Device Manual Supplement - Acyclic datasets and command interface).

8.6 AS-i slaves

Content

Profiles of AS-i slaves.....	122
------------------------------	-----

41533

Slave = Passive participant on the bus, only replies on request of the →master. Slaves have a clearly defined and unique →address in the bus.

8.6.1 Profiles of AS-i slaves

Content

Configuration data (CDI) of the slaves (slave profiles).....	123
Slave profiles for slaves with combined transaction.....	129
Combined transaction – Use of analogue channels in the gateway depending on the slave profile ...	129

41771

Configuration data (CDI) of the slaves (slave profiles)

Content

Structure of the slave profile.....	123
Description of the IO code for digital slaves	124
Description of the ID code (selection)	124
Description of the extended ID code 1	124
Description of the extended ID code 2	125
Valid combinations IO code / ID code / extended ID code 2.....	126

41591

The configuration data CDI (= **C**onfiguration **D**ata **I**mage) for single, A and B slaves is stored in a data word. The structure is shown below and is the same for all slaves.

Structure of the slave profile

41709

The slave profile has the following structure: S-[IO code].[ID code].[ext. ID code2]

Bits 15...12	Bits 11...8	Bits 7...4	Bits 3...0
XID2 extended ID code 2 3rd figure in the slave profile (AS-i slave v2.0 = 0xF *)	XID1 extended ID code 1 is <u>no</u> part of the slave profile can be changed by the user (AS-i slave v2.0 = 0xF *)	ID code ID code 2nd figure in the slave profile	IO code I/O configuration 1st figure in the slave profile
Example:	AC2255 4 digital inputs, 2 digital outputs AS-i profile = S-7.A.E This results in the following configuration data of the slave:		
0b1110 = 0xE	(e.g.) 0b0111 = 0x7	0b1010 = 0xA	0b0111 = 0x7
The corresponding CDI data word is: 11100111 10100111 = 0xE7A7			

*) AS-i slaves according to the AS-i specification 2.0 and older do not support the extended ID codes 1 and 2. In the master 0xF is stored for this configuration data.

Description of the IO code for digital slaves

41588

Structure slave profile = S-[IO-Code].x.x

IO code [hex]	IO code (bits 3...0)	Function of the periphery bit			
		D3	D2	D1	D0
0	0000	input	input	input	input
1	0001	output	input	input	input
2	0010	input / output	input	input	input
3	0011	output	output	input	input
4	0100	input / output	input / output	input	input
5	0101	output	output	output	input
6	0110	input / output	input / output	input / output	input
7	0111	input / output	input / output	input / output	input / output
8	1000	output	output	output	output
9	1001	input	output	output	output
A	1010	input / output	output	output	output
B	1011	input	input	output	output
C	1100	input / output	input / output	output	output
D	1101	input	input	input	output
E	1110	input / output	input / output	input / output	output
F	1111	not allowed			

Description of the ID code (selection)

41589

Structure slave profile = S-x.[ID-Code].x

ID code [hex]	ID code (Bits 3...0)	Description
0	0000	4 I/O connections for binary sensors and/or actuators with 1 signal each
1	0001	2 dual-signal I/O connections for binary sensors and/or actuators with 2 signals each
A	1010	slave operates in the extended addressing mode (B slave or A/B slave)
B	1011	slave corresponds to Safety-at-Work
F	1111	manufacturer-specific device (cannot be replaced with products from other manufacturers)

Description of the extended ID code 1

41585

Can be changed by the user, however not a part of the slave profile.

Default value:

0xF for single slaves

0x7 for A/B slaves

The value is evaluated and checked by the master. The user can make an additional distinction between slaves which do not differ in the AS-i system, e.g. slaves with different ranges for current, voltage or frequency. This prevents damage when replacing slaves with a wrong performance range.

Description of the extended ID code 2

41590

Extended ID code 2 for analogue slaves with profile 7.3.x

41514

The extended ID code 2 is used to specify complex slaves.

Structure slave profile = S-7.3.[ext.ID code2]

Bit 3	Bit 2	Bit 1	Bit 0	Description
		0	0	1-channel slave
		0	1	2-channel slave
		1	0	4-channel slave
		1	1	4-channel slave (if slave has no extended ID code)
	0			transparent data exchange = binary bits
	1			analogue value transmission
0				output slave
1				input slave

The ID code 2 results from a combination of the options stated above.

Extended ID code 2 for analogue slaves with profile 7.4.x

41513

The extended ID code 2 is used to specify complex slaves.

Structure slave profile = S-7.3.[ext. ID code2]

Bit 3	Bit 2	Bit 1	Bit 0	Description
		0	0	1-channel slave
		0	1	2-channel slave
		1	0	4-channel slave
		1	1	4-channel slave (if slave has no extended ID code)
0	0	0	0	4 binary inputs + 4 binary outputs
0				output slave
1				input slave

The ID code 2 results from a combination of the options stated above.

Valid combinations IO code / ID code / extended ID code 2

41677

Structure slave profile = S-[IO code].[ID code].[ext. ID code2]

IO code [hex]	ID code [hex]	Ext. ID code 2 [hex]	Meaning
0...E not: 9, B, D	0	x	binary I/O connections for sensors and actuators
0, 3, 8	1	x	1 or 2 binary sensors or actuators with 2 signals each (dual-signal devices)
0	1	x	4 binary inputs for 2 dual-signal sensors
0...E not: 2A	A	x	slave operates in the "extended addressing mode" (B slave or A/B slave)
0	A	E	slave with extended address function: 4 binary inputs for 2 dual-signal sensors (e.g. I/O module AC2250)
0	B	x	slave corresponds to Safety-at-Work
0...E	F	x	manufacturer-specific device (cannot be replaced by other products)
1	1	x	single sensor with remote setting: 3 binary inputs + 1 binary output (e.g. sensor OC5226)
3	1	x	2 binary inputs for 1 dual-signal sensor AND 2 binary outputs for 1 dual-signal actuator
3	A	x	slave with extended address function
3	A	1	slave with extended address function: 2 binary inputs + 1 binary output
3	A	2	slave with extended address function: 4 binary inputs
6	0	x	quick combined transaction type 5 of 8, 12 or 16 data bits by using 2, 3 or 4 slave addresses in a slave
7	0	F	motor starter 2I + 2O (e.g. ZB0032)
7	0	E	4 binary inputs + 4 binary outputs (e.g. I/O module AC2251)
7	1	x	interface for the transmission of 6...18-bit signals; analogue profile for combined transaction type 1; was replaced by S-7.3
7	2	x	extended slave profile for the transmission of 6...18-bit signals; extended analogue profile for combined transaction type 1; was replaced by S-7.4
7	3	x	slave profile for 16-bit transmission with integrated support in the master; integrated analogue profile for combined transaction type 1 (→ Extended ID code 2 for analogue slaves with profile 7.3.x (→ S. 125))
7	3	5	2 analogue outputs of 16 bits each (e.g. I/O module AC2618)
7	3	6	4 analogue outputs of 16 bits each (e.g. I/O module AC2518)
7	3	C	1 analogue input of 16 bits (e.g. sensor PPA020)
7	3	D	2 analogue inputs of 16 bits each (e.g. I/O module AC2616)
7	3	E	4 analogue inputs of 16 bits each (e.g. I/O module AC2516)
7	4	x	extended slave profile for 16-bit transmission with integrated support in the master; integrated extended analogue profile for combined transaction type 1 (→ Extended ID code 2 for analogue slaves with profile 7.4.x (→ S. 125))
7	4	C	RFID identification system for writing and reading RFID tags 15-bit data + 1-bit messages (e.g. DTA100)
7	A	x	slave operates in the "extended addressing mode" (B slave or A/B slave)

IO code [hex]	ID code [hex]	Ext. ID code 2 [hex]	Meaning
7	A	5	slave operates in the "extended addressing mode" (B slave or A/B slave) combined slave; supports combined transaction type 2
7	A	7	slave operates in the "extended addressing mode" (B slave or A/B slave) 4 binary inputs + 4 binary outputs
7	A	8	slave operates in the "extended addressing mode" (B slave or A/B slave) 1 channel for combined transaction type 4
7	A	9	slave operates in the "extended addressing mode" (B slave or A/B slave) dual channel for combined transaction type 4
7	A	A	slave operates in the "extended addressing mode" (B slave or A/B slave) 8 binary inputs + 8 binary outputs
7	A	E	slave operates in the "extended addressing mode" (B slave or A/B slave); dual sensor with actuator interface (e.g. sensor AC2317); 2 binary inputs + 2 binary outputs
7	B	x	safety slave with non-safe outputs
7	B	0	safety slave with non-safe outputs; 2 safe binary inputs (e.g. I/O module AC005S)
7	B	E	safety sensor with non-safe outputs; 2 safe binary inputs AND 2 safe binary outputs AND 2 non-safe (relay) outputs (e.g. I/O module AC009S)
7	D	x	device for motor control (electromechanical)
7	D	0	electromechanical motor control with open sub-profile
7	D	1	electromechanical direct starter
7	D	2	electromechanical reverser
7	D	3	electromechanical direct starter with brake
7	D	4	electromechanical reverser with brake
7	D	5	electromechanical direct starter with accessories
7	D	6	electromechanical reverser with accessories
7	E	x	device for motor control (electronic)
7	E	0	electronic motor control with open sub-profile
7	E	1	electronic direct starter
7	E	2	electronic reverser
7	E	3	electronic direct starter with brake
7	E	4	electronic reverser with brake
7	E	5	electronic direct starter with accessories
7	E	6	electronic reverser with accessories
8	1	x	4 binary outputs for 2 dual-signal actuators
B	1	x	dual-signal actuator with feedback: 2 binary outputs + 2 binary inputs
B	A	5	slave operates in the "extended addressing mode" (B slave or A/B slave); supports combined transaction type 2
B	A	E	slave operates in the "extended addressing mode" (B slave or A/B slave); 2 binary outputs + 2 binary inputs (e.g. AC2086 module)
D	1	x	single actuator with monitoring: 1 binary output + 3 binary inputs

x = any value (0...F)

Devices with M4 master profile enable connection of slaves with more than 4 digital inputs/outputs. The transmission is combined: Part of the data transmission is carried out via the digital bits D0...D3, another part via the "analogue" channels.



The more data is transmitted, the longer it takes until all data of a slave has been transmitted.

Cycle time single slave = 5 ms

Cycle time A/B slave (if address is only assigned to A or B slave) = 5 ms

Cycle time A/B slave (if address is assigned to A and B slave) = 10 ms

The cycle time for CTT transmission is a multiple of these values for individual data.

CTT = Combined Transaction Type

Slave profiles for slaves with combined transaction

41654

Structure slave profile = S-[IO-Code].[ID-Code].[ext.ID-Code2]

Slave profile	Master profile	Assignment analogue channels in the device		Bits D0...D3	Additional acyclic string data transaction	Combined transaction CTT
		Number of channels	Use analogue / digital			
S-6.0	M4	1 I and 1 O	2/3/4 x 4 binary inputs and 2/3/4 x 4 binary outputs	—	no	type 5
S-7.3	M3	1/2/4 I or 1/2/4 O	1/2/4 analogue inputs or 1/2/4 binary outputs	—	no	type 1
S-7.4	M3	1/2/4 I or 1/2/4 O	1/2/4 analogue inputs or 1/2/4 binary outputs	4 inputs or 4 outputs	yes	type 1
S-7.5.5	M4	0...4 I and 0...4 O	0...4 analogue inputs or < 65 binary inputs and 0...4 analogue outputs or < 65 binary outputs	2 inputs and 2 outputs	yes	type 2
S-7.A.5	M4	0...2 I and 0...2 O	0...2 analogue inputs or < 33 binary inputs and 0...2 analogue outputs or < 33 binary outputs	2 inputs and 1 output	yes	type 2
S-7.A.7	M4	—	—	4 inputs and 4 outputs	no	type 3
S-7.A.8	M4	1 I	1 analogue input or < 17 binary inputs	1 output	no	type 4
S-7.A.9	M4	2 I	2 analogue inputs or < 33 binary inputs	—	no	type 4
S-7.A.A	M4	1 I and 1 O	8 binary inputs and 8 binary outputs	—	no	type 3
S-B.A.5	M4	0...2 I and 0...2 O	0...2 analogue inputs or < 33 binary inputs and 0...2 analogue outputs or < 33 binary outputs	—	yes	type 2

Legend colour pattern:



Combined transaction – Use of analogue channels in the gateway depending on the slave profile

41592

Transaction	Slave profile	Slave type	Number channels	Analogue input channels					Analogue output channels								
				CH3	CH2	CH1	CH0	Trans.	CH3	CH2	CH1	CH0	Trans.				
CTT5	6.0.x	S	1	-	-	-	b	-	-	-	-	b	-				
CTT1	7.3.C	S	1	-	-	-	a	-	-	-	-	-	-				
	7.3.D	S	2	-	-	a	a	-	-	-	-	-	-				
	7.3.E	S	4	a	a	a	a	-	-	-	-	-	-				
	7.3.4	S	1	-	-	-	-	-	-	-	-	a	-				
	7.3.5	S	2	-	-	-	-	-	-	-	a	a	-				
	7.3.6	S	4	-	-	-	-	-	a	a	a	a	-				
	7.3.C	S	1	-	-	-	a	-	-	-	-	-	-				
	7.3.D	S	2	-	-	a	a	-	-	-	-	-	-				
	7.3.E	S	4	a	a	a	a	-	-	-	-	-	-				
	7.3.4	S	1	-	-	-	-	-	-	-	-	a	-				
	7.3.5	S	2	-	-	-	-	-	-	-	a	a	-				
7.3.6	S	4	-	-	-	-	-	a	a	a	a	-					
CTT1	7.4.4	S	1	-	-	-	-	-	-	-	-	a	X				
	7.4.5	S	2	-	-	-	-	-	-	-	a	a	X				
	7.4.6	S	4	-	-	-	-	-	a	a	a	a	X				
	7.4.C	S	1	-	-	-	a	X	-	-	-	-	-				
	7.4.D	S	2	-	-	a	a	X	-	-	-	-	-				
	7.4.E	S	4	a	a	a	a	X	-	-	-	-	-				
CTT2	7.5.5	S	0..4	a	b	a	b	a	b	a	b	a	b	X			
CTT2	7.A.5	A	0..2	-	-	a	b	a	b	X	-	-	a	b	a	b	X
	7.A.5	B	0..2	a	b	a	b	-	-	X	a	b	a	b	-	-	X
CTT3	7.A.7	A	-	only binary					-	only binary					-		
		B	-						-						-		
CTT4	7.A.8	A	1	-	-	-	a	b	-	-	-	-	-	-			
		B	1	-	a	b	-	-	-	-	-	-	-	-			
CTT4	7.A.9	A	2	-	-	a	b	a	b	-	-	-	-	-			
		B	2	a	b	a	b	-	-	-	-	-	-	-			
CTT3	7.A.A	A	1	-	-	-	b	-	-	-	-	-	b	-			
		B	1	-	b	-	-	-	-	-	b	-	-	-			
CTT2	B.A.5	A	0..2	-	-	a	b	a	b	X	-	-	a	b	a	b	X
	B.A.5	B	0..2	a	b	a	b	-	-	X	a	b	a	b	-	-	X

CHn = channel
Trans. = transparent mode
S = single slave
A = A slave
B = B slave
a = analogue inputs/outputs (word)
b = binary inputs/outputs (bits)
- = not used
X = additional acyclic transaction of strings for device, parameters, diagnosis

Legend colour pattern:

binary inputs	binary outputs	analogue inputs	analogue outputs
---------------	----------------	-----------------	------------------

8.7 Fieldbus Profinet

41512

PROFINET (**Process Field Network**) is the open Industrial Ethernet Standard of Profibus & Profinet International (PI) for automation. Profinet uses TCP/IP and IT standards, is real-time Ethernet compatible and enables the integration of fieldbus systems.

The Profinet concept has a modular design, so that the user can choose the functionality himself. This is basically different as regards the type of data exchange, to meet the requirements regarding the speed.

For Profinet, there are the two perspectives Profinet-CBA and Profinet-IO:

- Profinet-CBA (Component Based Automation) is intended for the component-based communication via TCP/IP and the real-time communication for real-time requirements in modular plant construction. Both ways of communication can be used in parallel.
- Profinet-IO has been created for real-time (RT) and synchronous communication IRT (IRT = isochronous real-time) with the decentralised periphery. The designations RT and IRT only describe the real-time characteristics in the communication within Profinet-IO.



→ www.profibus.com (umbrella organisation)

8.7.1 Fieldbus parameters

41508

The fieldbus parameters provide information for the integration of the device into the PROFINET network. The fieldbus parameters are set directly on the device.

Parameter	Meaning	Value range
IP address	IP address (IPv4) of the device's PROFINET interface	e.g.: 192.168.0.200
Subnet mask	Subnet mask of the PROFINET network segment	e.g.: 255.255.255.0
Gateway address	IP address (IPv4) of the PROFINET gateway	e.g.: 192.168.0.100

8.7.2 Parameter data



41785

The parameter data enable an individual setting of the system. The parameter data is set via slot 0 of the system.

In the Siemens Step7 configuration tool "HW-Config." the parameter data is accessed by double-click on slot 0 of the device. All necessary settings can be made in the tab [Parameters].

Parameters: Compact Mode

41802

Parameter	Description	Value range	
Analogue channels per input slave	Number the analogue channels per input slave	4 channels* =	4 channels (Variable slave assignment)
		2 channels =	2 channels (Fixed slave assignment)
		1 channel =	1 channel (Fixed slave assignment)
Analogue channels per output slave	Number of analogue channels per output slave	4 channels* =	4 channels (Variable slave assignment)
		2 channels =	2 channels Fixed slave assignment)
		1 channel =	1 channel (Fixed slave assignment)
1. analogue input slave ... 31. analog input slave	Assignment of the AS-i slave address to a position in the analogue input data image. Condition: Parameter [Analog channels per input slave] = 4 channels  For each AS-i analogue slave 4 words at data are reserved.	Slave 1 AS-i master 1* ... Slave 15 AS-i master 1* Slave 17 AS-i master 1 ... Slave 31 AS-i master 1 Slave 1 AS-i master 2 ... Slave 31 AS-i master 2	
1. analog output slave ... 31. analog output slave	Assignment of the AS-i slave address to a position in the analogue output data image. Condition: Parameter [Analog channels per output slave] = 4 channels  For each AS-i analogue slave 4 words of data are reserved.	Slave 1 AS-i master 1 ... Slave 16 AS-i master 1 Slave 17 AS-i master 1* ... Slave 31 AS-i master 1* Slave 1 AS-i master 2 ... Slave 31 AS-i master 2	
Failsafe state	Behaviour of the slave outputs if an interrupted fieldbus connection is detected	Clear outputs* =	All AS-i outputs are switched off in case of an interrupted PROFINET connection (value = 0).
		Hold outputs =	The outputs are held in the last valid state that existed before the interrupted connection was detected.
PROFINET alarms	Transmission of the PROFINET alarms	Disable =	The PROFINET alarm data is NOT written to the AS-i system.
		Enable* =	The PROFINET alarm data is written to the AS-i system.
Swap IO mapping slot 1...4	Slave assignment in the bytes of the digital data	yes* =	Slave n+1 / slave n
		no =	Slave n / slave n+1

Parameter	Description	Value range	
AS-i param. download	Transmission of the slave parameters when downloading a configuration from the PROFINET projection software.	Disable* =	The following slave parameter data are NOT downloaded to the device. The parameters set in the device apply.
		Enable =	Each time the PROFINET connection is established, the following slave parameter data are downloaded to the device, activated in the AS-i slaves, and stored non-volatilely.
Param. slave 1(A) AS-i master 1 ... Param. slave 31(A) AS-i master 1 Param. slave 1B AS-i master 1 ... Param. slave 31B AS-i master 1 Param. slave 1(A) AS-i master 2 ... Param. slave 31(A) AS-i master 2 Param. slave 1B AS-i master 2 ... Param. slave 31B AS-i master 2	Parameter data of the AS-i slaves. The set values are only activated when the parameter "AS-i param. download" is set to the value "Enable".	P3..P0 = P3..P0 = ... P3..P0** = ... P3..P0* =	2#0000 / 16#0 2#0001 / 16#1 ... 2#0111 / 16#7 ... 2#1111 / 16#F

* ... Default setting for single slaves

** ... Default setting for A/B slaves

Parameters: Flexible mode

Parameter	Description	Values	
Failsafe state	Behaviour of the slave outputs if an interrupted fieldbus connection is detected	Clear outputs* =	All AS-i outputs are switched off in case of an interrupted PROFINET connection (value = 0).
		Hold outputs =	The outputs are held in the last valid state that existed before the interrupted connection was detected.
PROFINET alarms	Transmission of the PROFINET alarms	Disable =	The PROFINET alarm data is NOT written to the AS-i system.
		Enable* =	The PROFINET alarm data is written to the AS-i system.
Swap IO mapping slot 1...4	Slave assignment in the bytes of the digital data	yes* =	Slave n+1 / slave n
		no =	Slave n / slave n+1
AS-i param. download	Transmission of the slave parameters when downloading a configuration from the PROFINET projection software.	Disable* =	The following slave parameter data are NOT downloaded to the device. The parameters set in the device apply.
		Enable =	Each time the PROFINET connection is established, the following slave parameter data are downloaded to the device, activated in the AS-i slaves, and stored non-volatilely.
Param. slave 1(A) AS-i master 1 ... Param. slave 31(A) AS-i master 1 Param. slave 1B AS-i master 1 ... Param. slave 31B AS-i master 1 Param. slave 1(A) AS-i master 2 ... Param. slave 31(A) AS-i master 2 Param. slave 1B AS-i master 2 ... Param. slave 31B AS-i master 2	Parameter data of the AS-i slaves. The set values are only activated when the parameter "AS-i param. download" is set to the value "Enable".	P3..P0 = P3..P0 = ... P3..P0** = ... P3..P0* =	2#0000 / 16#0 2#0001 / 16#1 ... 2#0111 / 16#7 ... 2#1111 / 16#F

* ... Default setting

** ... Default setting for A/B slaves

GSDML file

To represent the Profinet gateway in a fieldbus projection software (e.g. Siemens Step7) a GSDML file is provided.

The GSDML file for the **ifm** AS-i PROFINET gateway AC1403/04 is stored in the device and can be loaded to the configuration PC via the web interface (→ [Download GSDML file](#) (→ S. [87](#))). All parameter and process data which is valid for the device is defined in the GSDML file.



On the Siemens Step7 object manager:

The object manager is part of the hardware configuration in Step7. It provides the device catalogue containing all devices which are available for projection. The catalogue consists of two parts. All non Siemens devices are listed in "Profinet – Further fieldbus devices". These devices are described using GSDML files which are imported into Step7.

8.7.3 Cyclic data

41567

The cyclic process data is, as the name suggests, cyclically updated via the fieldbus mechanisms.

For this, it must be defined in the fieldbus configuration which data with which lengths in which address areas of the host controller are to be used.

So-called slots contain each the process data of several AS-i slaves.

PROFINET modules

42063

The following tables show the available PROFINET modules in the flexible mode and in the compact mode.

PROFINET modules: Flexible mode

41550

Slot	Description	Detailed information
1	Digital input/output data AS-i Master 1 for single and A slaves	→ Slot 1 – Digital inputs/outputs of single/A slaves, AS-i master 1 (→ S. 137)
2	Digital input/output data AS-i Master 2 for single and A slaves	→ Slot 2 – Digital inputs/outputs of single/A slaves, AS-i master 2 (→ S. 137)
3	Digital input/output data AS-i Master 1 for B slaves	→ Slot 3 – Digital inputs/outputs of B slaves, AS-i master 1 (→ S. 138)
4	Digital input/output data AS-i Master 2 for B slaves	→ Slot 4 – Digital inputs/outputs of B slaves, AS-i master 2 (→ S. 138)
7	Data from the device-internal SPS to the higher-level fieldbus PLC	→ Slot 7 - Inputs from AC1403/04 SPS (→ S. 149)
8	Data of the higher-level fieldbus PLC to the device-internal SPS	→ Slot 8 - Outputs to AC1403/04 SPS (→ S. 150)
101... 131*	Analogue data at AS-i Master 1 can be configured via projection software at the PROFINET-host)	→ Slot 1ss/2ss – flex modules for analogue slaves (→ S. 148)
201... 231*	Analogue data at AS-i Master 2 can be configured via projection software at the PROFINET-host (only available for devices with 2 AS-i masters)	

* ... 1ss = AS-i master 1 ss = slave address
2ss = AS-i master 2

PROFINET modules: Compact Mode

Slot	Description	Detailed information
1	Digital input/output data AS-i Master 1 for single and A slaves	→ Slot 1 – Digital inputs/outputs of single/A slaves, AS-i master 1 (→ S. 137)
2	Digital input/output data AS-i Master 2 for single and A slaves	→ Slot 2 – Digital inputs/outputs of single/A slaves, AS-i master 2 (→ S. 137)
3	Digital input/output data AS-i Master 1 for B slaves	→ Slot 3 – Digital inputs/outputs of B slaves, AS-i master 1 (→ S. 138)
4	Digital input/output data AS-i Master 2 for B slaves	→ Slot 4 – Digital inputs/outputs of B slaves, AS-i master 2 (→ S. 138)
5	Analogue input data can be configured via device parameters (→ Parameter data (→ S. 132))	→ Slot 5 – Analogue input data (→ S. 141)
6	Analogue output data can be configured via device parameters (→ Parameter data (→ S. 132))	→ Slot 6 – Analogue output data (→ S. 142)
7	Data from the device-internal SPS to the higher-level fieldbus controller	→ Slot 7 - Inputs from AC1403/04 SPS (→ S. 149)
8	Data of the higher-level fieldbus controller to the device-internal SPS	→ Slot 8 - Outputs to AC1403/04 SPS (→ S. 150)

Slot 1 – Digital inputs/outputs of single/A slaves, AS-i master 1

41656

Slot	Description	Value range	Length [bytes]
1	Digital inputs/outputs of single or A slaves, connected to AS-i master 1	S/A slaves 01...07AS-i 1 = S/A slaves 1 to 7 of AS-i Master 1	4
		S/A slaves 01...15AS-i 1 = S/A slaves 1 to 15 of AS-i Master 1	8
		S/A slaves 01...23AS-i 1 = S/A slaves 1 to 23 of AS-i Master 1	12
		all S/A slavesAS-i 1 = all S/A slaves of AS-i Master 1	16

In each 4-byte data block, the data of 8 AS-i slaves is transmitted (→ **Mapping of the digital input/output data** (→ S. [139](#))).

Slot 2 – Digital inputs/outputs of single/A slaves, AS-i master 2

41616

Slot	Description	Value range	Length [bytes]
2	Digital inputs/outputs of single or A slaves, connected to AS-i master 2 (only available for devices with 2 AS-i masters)	S/A slaves 01...07AS-i 2 = S/A slaves 1 to 7 of AS-i Master 2	4
		S/A slaves 01...15AS-i 2 = S/A slaves 1 to 15 of AS-i Master 2	8
		S/A slaves 01...23AS-i 2 = S/A slaves 1 to 23 of AS-i Master 2	12
		all S/A slavesAS-i 2 = all S/A slaves of AS-i Master 2	16

In each 4-byte data block, the data of 8 AS-i slaves is transmitted (→ **Mapping of the digital input/output data** (→ S. [139](#))).

Slot 3 – Digital inputs/outputs of B slaves, AS-i master 1

41619

Slot	Description	Value range	Length [bytes]
3	Digital inputs/outputs of B slaves, connected to AS-i master 1	B-slaves 01...07AS-i 1 = B slaves 1 to 7 of AS-i Master 1	4
		B-slaves 01...15AS-i 1 = B slaves 1 to 15 of AS-i Master 1	8
		B-slaves 01...23AS-i 1 = B slaves 1 to 23 of AS-i Master 1	12
		all B slavesAS-i 1 = all B slaves of AS-i Master 1	16

In each 4-byte data block, the data of 8 AS-i slaves is transmitted (→ **Mapping of the digital input/output data** (→ S. [139](#))).

Slot 4 – Digital inputs/outputs of B slaves, AS-i master 2

41636

Slot	Description	Value range	Length [bytes]
4	Digital inputs/outputs of B slaves, connected to AS-i master 2 (only available for devices with 2 AS-i masters)	B-slaves 01...07AS-i 2 = B slaves 1 to 7 of AS-i Master 2	4
		B-slaves 01...15AS-i 2 = B slaves 1 to 15 of AS-i Master 2	8
		B-slaves 01...23AS-i 2 = B slaves 1 to 23 of AS-i Master 2	12
		all B slavesAS-i 2 = all B slaves of AS-i Master 2	16

In each 4-byte data block, the data of 8 AS-i slaves is transmitted (→ **Mapping of the digital input/output data** (→ S. [139](#))).

Mapping of the digital input/output data

The following table shows in which area of a byte the input/output data of each slave are transmitted.

Byte no.	Bits 4...7	Bits 0...3	Content			
			S/A slaves 01...07 B slaves 01...07	S/A slaves 01...15 B slaves 01...15	S/A slaves 01...23 B slaves 01...23	all S/A slaves all B slaves
1	Master flags ¹ Master flags	Slave 1(A) Slave 1B	X	X	X	X
2	Slave 2(A) Slave 2B	Slave 3(A) Slave 3B	X	X	X	X
3	Slave 4(A) Slave 4B	Slave 5(A) Slave 5B	X	X	X	X
4	Slave 6(A) Slave 6B	Slave 7(A) Slave 7B	X	X	X	X
5	Slave 8(A) Slave 8B	Slave 9(A) Slave 9B		X	X	X
6	Slave 10(A) Slave 10B	Slave 11(A) Slave 11B		X	X	X
7	Slave 12(A) Slave 12B	Slave 13(A) Slave 13B		X	X	X
8	Slave 14(A) Slave 14B	Slave 15(A) Slave 15B		X	X	X
9	Slave 16(A) Slave 16B	Slave 17(A) Slave 17B			X	X
10	Slave 18(A) Slave 18B	Slave 19(A) Slave 19B			X	X
11	Slave 20(A) Slave 20B	Slave 21(A) Slave 21B			X	X
12	Slave 22(A) Slave 22B	Slave 23(A) Slave 23B			X	X
13	Slave 24(A) Slave 24B	Slave 25(A) Slave 25B				X
14	Slave 26(A) Slave 26B	Slave 27(A) Slave 27B				X
15	Slave 28(A) Slave 28 B	Slave 29(A) Slave 29B				X
16	Slave 30(A) Slave 30B	Slave 31(A) Slave 31B				X

Legend:

¹ ... The master flags (M flags) are only transmitted in the digital input data (→ **Table: Master flags** (→ S. 140)).

Table: Master flags

41666

Bits 4...7 of the first byte of the digital input data contain the master flags. They provide information on the operating state of the AS-i master.

Bit 7	Bit 6	Bit 5	Bit 4
AS-i power fail (19 V)	Configuration error in the AS-i system	AS-i master is offline	Periphery fault



In the digital output data, bits 4...7 have no relevance and are not evaluated!

Slot 5 – Analogue input data

Slot	Description	Value range	Length [Words]
5	Analogue inputs of up to 31 single or A slaves, connected to AS-i master 1 or 2 (master 2 only available for devices with 2 AS-i masters) 1 / 2 / 4 channels per AS-i slave Define number of analogue channels and slave number by means of device parameters.	No analogue IN = module is disabled	0
		004 words = 4 words analogue inputs	4
		008 words = 8 words analogue inputs	8
		012 words = 12 words analogue inputs	12
		016 words = 16 words analogue inputs	16
		020 words = 20 words analogue inputs	20
		024 words = 24 words analogue inputs	24
		028 words = 28 words analogue inputs	28
		032 words = 32 words analogue inputs	32
		036 words = 36 words analogue inputs	36
		040 words = 40 words analogue inputs	40
		044 words = 44 words analogue inputs	44
		048 words = 48 words analogue inputs	48
		052 words = 52 words analogue inputs	52
		056 words = 56 words analogue inputs	56
		060 words = 60 words analogue inputs	60
076 words = 76 words analogue inputs	76		
092 words = 92 words analogue inputs	92		
108 words = 108 words analogue inputs	108		
124 words = 124 words analogue inputs	124		

In each word, the 16 bit value of the analogue channel is transferred (→ **Configuration of the analogue channels in the slots 5 ... 6** (→ S. [143](#))).



The valid and overflow flags which each analogue AS-i input slaves provides for each channel are NOT represented here.

Slot 6 – Analogue output data

41630

Slot	Description	Value range	Length [Words]
6	Analogue inputs of up to 31 single or A slaves, connected to AS-i master 1 or 2 (master 2 only available for devices with 2 AS-i masters) 1 / 2 / 4 channels per AS-i slave Define number of analogue channels and slave number by means of device parameters.	No analogue outputs = module is disabled	0
		004 words = 4 words analogue outputs	4
		008 words = 8 words analogue outputs	8
		012 words = 12 words analogue outputs	12
		016 words = 16 words analogue outputs	16
		020 words = 20 words analogue outputs	20
		024 words = 24 words analogue outputs	24
		028 words = 28 words analogue outputs	28
		032 words = 32 words analogue outputs	32
		036 words = 36 words analogue outputs	36
		040 words = 40 words analogue outputs	40
		044 words = 44 words analogue outputs	44
		048 words = 48 words analogue outputs	48
		052 words = 52 words analogue outputs	52
		056 words = 56 words analogue outputs	56
		060 words = 60 words analogue outputs	60
076 words = 76 words analogue outputs	76		
092 words = 92 words analogue outputs	92		
108 words = 108 words analogue outputs	108		
124 words = 124 words analogue outputs	124		

In each word, the 16 bit value of the analogue channel is transferred (→ **Configuration of the analogue channels in the slots 5 ... 6** (→ S. [143](#))).

Configuration of the analogue channels in the slots 5 ... 6

41605

The configuration of the device parameters [analogue channels per input slave] und [analogue channels per output slave] determines which analogue channels of the AS-i slaves are transferred. The following table shows the relevance of the parameter values that can be set:

Parameter value	Description
1 channel	<p>Fixed slave assignment</p> <p>The first channel of the slave addresses 1 to 30 of AS-i Master 1 and AS-i Master 2 is transmitted. The assignment of the slaves is fixed (→ Table: Fixed slave assignment for slots 5...6 (→ S. 144)). A configuration of the slave order in the device-specific parameters is ineffective.</p>
2 channels	<p>Fixed slave assignment</p> <p>Channels 1 and 2 of the slave addresses 1 to 31 of AS-i Master 1 and AS-i Master 2 are transmitted. The assignment of the slaves is fixed (→ Table: Fixed slave assignment for slots 5...6 (→ S. 144)). A configuration of the slave order in the device-specific parameters is ineffective.</p>
4 channels	<p>Variable slave assignment</p> <p>From up to 31 slaves of AS-i Master 1 and/or AS-i Master 2 4 channels each (with 16 bits each) are transferred with analogue data (→ Table: Variable slave assignment for slots 5...6 (→ S. 147)).</p> <p>Selection of the slaves to be transmitted via the following device parameters:</p> <ul style="list-style-type: none"> - input data: x. Analogue input slave - output data: x. Analogue output slave

Table: Fixed slave assignment for slots 5..6

41413

The following table shows all possible combinations of data for the parameters:

- Analogue channels per input slave = 1
- Analogue channels per input slave = 2
- Analogue channels per output slave = 1
- Analogue channels per output slave = 2

Word	Setting of the device parameters	
	1 channel	2 channels
1	AS-i master 1 / slave 1(A) / Channel 1	AS-i master 1 / slave 1(A) / Channel 1
2	AS-i master 1 / slave 2(A) / Channel 1	AS-i master 1 / slave 1(A) / Channel 2
3	AS-i master 1 / slave 3(A) / Channel 1	AS-i master 1 / slave 2(A) / Channel 1
4	AS-i master 1 / slave 4(A) / Channel 1	AS-i master 1 / slave 2(A) / Channel 2
5	AS-i master 1 / slave 5(A) / Channel 1	AS-i master 1 / slave 3(A) / Channel 1
6	AS-i master 1 / slave 6(A) / Channel 1	AS-i master 1 / slave 3(A) / Channel 2
7	AS-i master 1 / slave 7(A) / Channel 1	AS-i master 1 / slave 4(A) / Channel 1
8	AS-i master 1 / slave 8(A) / Channel 1	AS-i master 1 / slave 4(A) / Channel 2
9	AS-i master 1 / slave 9(A) / Channel 1	AS-i master 1 / slave 5(A) / Channel 1
10	AS-i master 1 / slave 10(A) / Channel 1	AS-i master 1 / slave 5(A) / Channel 2
11	AS-i master 1 / slave 11(A) / Channel 1	AS-i master 1 / slave 6(A) / Channel 1
12	AS-i master 1 / slave 12(A) / Channel 1	AS-i master 1 / slave 6(A) / Channel 2
13	AS-i master 1 / slave 13(A) / Channel 1	AS-i master 1 / slave 7(A) / Channel 1
14	AS-i master 1 / slave 14(A) / Channel 1	AS-i master 1 / slave 7(A) / Channel 2
15	AS-i master 1 / slave 15(A) / Channel 1	AS-i master 1 / slave 8(A) / Channel 1
16	AS-i master 1 / slave 16(A) / Channel 1	AS-i master 1 / slave 8(A) / Channel 2
17	AS-i master 1 / slave 17(A) / Channel 1	AS-i master 1 / slave 9(A) / Channel 1
18	AS-i master 1 / slave 18(A) / Channel 1	AS-i master 1 / slave 9(A) / Channel 2
19	AS-i master 1 / slave 19(A) / Channel 1	AS-i master 1 / slave 10(A) / Channel 1
20	AS-i master 1 / slave 20(A) / Channel 1	AS-i master 1 / slave 10(A) / Channel 2
21	AS-i master 1 / slave 21(A) / Channel 1	AS-i master 1 / slave 11(A) / Channel 1
22	AS-i master 1 / slave 22(A) / Channel 1	AS-i master 1 / slave 11(A) / Channel 2
23	AS-i master 1 / slave 23(A) / Channel 1	AS-i master 1 / slave 12(A) / Channel 1
24	AS-i master 1 / slave 24(A) / Channel 1	AS-i master 1 / slave 12(A) / Channel 2
25	AS-i master 1 / slave 25(A) / Channel 1	AS-i master 1 / slave 13(A) / Channel 1
26	AS-i master 1 / slave 26(A) / Channel 1	AS-i master 1 / slave 13(A) / Channel 2
27	AS-i master 1 / slave 27(A) / Channel 1	AS-i master 1 / slave 14(A) / Channel 1
28	AS-i master 1 / slave 28(A) / Channel 1	AS-i master 1 / slave 14(A) / Channel 2
29	AS-i master 1 / slave 29(A) / Channel 1	AS-i master 1 / slave 15(A) / Channel 1
30	AS-i master 1 / slave 30(A) / Channel 1	AS-i master 1 / slave 15(A) / Channel 2
31	AS-i master 2 / slave 1(A) / Channel 1	AS-i master 1 / slave 16(A) / Channel 1
32	AS-i master 2 / slave 2(A) / Channel 1	AS-i master 1 / slave 16(A) / Channel 2

Word	Setting of the device parameters	
	1 channel	2 channels
33	AS-i master 2 / slave 3(A) / Channel 1	AS-i master 1 / slave 17(A) / Channel 1
34	AS-i master 2 / slave 4(A) / Channel 1	AS-i master 1 / slave 17(A) / Channel 2
35	AS-i master 2 / slave 5(A) / Channel 1	AS-i master 1 / slave 18(A) / Channel 1
36	AS-i master 2 / slave 6(A) / Channel 1	AS-i master 1 / slave 18(A) / Channel 2
37	AS-i master 2 / slave 7(A) / Channel 1	AS-i master 1 / slave 19(A) / Channel 1
38	AS-i master 2 / slave 8(A) / Channel 1	AS-i master 1 / slave 19(A) / Channel 2
39	AS-i master 2 / slave 9(A) / Channel 1	AS-i master 1 / slave 20(A) / Channel 1
40	AS-i master 2 / slave 10(A) / Channel 1	AS-i master 1 / slave 20(A) / Channel 2
41	AS-i master 2 / slave 11(A) / Channel 1	AS-i master 1 / slave 21(A) / Channel 1
42	AS-i master 2 / slave 12(A) / Channel 1	AS-i master 1 / slave 21(A) / Channel 2
43	AS-i master 2 / slave 13(A) / Channel 1	AS-i master 1 / slave 22(A) / Channel 1
44	AS-i master 2 / slave 14(A) / Channel 1	AS-i master 1 / slave 22(A) / Channel 2
45	AS-i master 2 / slave 15(A) / Channel 1	AS-i master 1 / slave 23(A) / Channel 1
46	AS-i master 2 / slave 16(A) / Channel 1	AS-i master 1 / slave 23(A) / Channel 2
47	AS-i master 2 / slave 17(A) / Channel 1	AS-i master 1 / slave 24(A) / Channel 1
48	AS-i master 2 / slave 18(A) / Channel 1	AS-i master 1 / slave 24(A) / Channel 2
49	AS-i master 2 / slave 19(A) / Channel 1	AS-i master 1 / slave 25(A) / Channel 1
50	AS-i master 2 / slave 20(A) / Channel 1	AS-i master 1 / slave 25(A) / Channel 2
51	AS-i master 2 / slave 21(A) / Channel 1	AS-i master 1 / slave 26(A) / Channel 1
52	AS-i master 2 / slave 22(A) / Channel 1	AS-i master 1 / slave 26(A) / Channel 2
53	AS-i Master 2 / slave 23(A) / Channel 1	AS-i master 1 / slave 27(A) / Channel 1
54	AS-i master 2 / slave 24(A) / Channel 1	AS-i master 1 / slave 27(A) / Channel 2
55	AS-i master 2 / slave 25(A) / Channel 1	AS-i master 1 / slave 28(A) / Channel 1
56	AS-i master 2 / slave 26(A) / Channel 1	AS-i master 1 / slave 28(A) / Channel 2
57	AS-i master 2 / slave 27(A) / Channel 1	AS-i master 1 / slave 29(A) / Channel 1
58	AS-i master 2 / slave 28(A) / Channel 1	AS-i master 1 / slave 29(A) / Channel 2
59	AS-i master 2 / slave 29(A) / Channel 1	AS-i master 1 / slave 30(A) / Channel 1
60	AS-i master 2 / slave 30(A) / Channel 1	AS-i master 1 / slave 30(A) / Channel 2
61	–	AS-i master 1 / slave 31(A) / Channel 1
62	–	AS-i master 1 / slave 31(A) / Channel 2
63	–	AS-i master 2 / slave 1(A) / Channel 1
64	–	AS-i master 2 / slave 1(A) / Channel 2
65	–	AS-i master 2 / slave 2(A) / Channel 1
66	–	AS-i master 2 / slave 2(A) / Channel 2
67	–	AS-i master 2 / slave 3(A) / Channel 1
68	–	AS-i master 2 / slave 3(A) / Channel 2
69	–	AS-i master 2 / slave 4(A) / Channel 1
70	–	AS-i master 2 / slave 4(A) / Channel 2
71	–	AS-i master 2 / slave 5(A) / Channel 1
72	–	AS-i master 2 / slave 5(A) / Channel 2

Word	Setting of the device parameters	
	1 channel	2 channels
73	–	AS-i master 2 / slave 6(A) / Channel 1
74	–	AS-i master 2 / slave 6(A) / Channel 2
75	–	AS-i master 2 / slave 7(A) / Channel 1
76	–	AS-i master 2 / slave 7(A) / Channel 2
77	–	AS-i master 2 / slave 8(A) / Channel 1
78	–	AS-i master 2 / slave 8(A) / Channel 2
79	–	AS-i master 2 / slave 9(A) / Channel 1
80	–	AS-i master 2 / slave 9(A) / Channel 2
81	–	AS-i master 2 / slave 10(A) / Channel 1
82	–	AS-i master 2 / slave 10(A) / Channel 2
83	–	AS-i master 2 / slave 11(A) / Channel 1
84	–	AS-i master 2 / slave 11(A) / Channel 2
85	–	AS-i master 2 / slave 12(A) / Channel 1
86	–	AS-i master 2 / slave 12(A) / Channel 2
87	–	AS-i master 2 / slave 13(A) / Channel 1
88	–	AS-i master 2 / slave 13(A) / Channel 2
89	–	AS-i master 2 / slave 14(A) / Channel 1
90	–	AS-i master 2 / slave 14(A) / Channel 2
91	–	AS-i master 2 / slave 15(A) / Channel 1
92	–	AS-i master 2 / slave 15(A) / Channel 2
93	–	AS-i master 2 / slave 16(A) / Channel 1
94	–	AS-i master 2 / slave 16(A) / Channel 2
95	–	AS-i master 2 / slave 17(A) / Channel 1
96	–	AS-i master 2 / slave 17(A) / Channel 2
97	–	AS-i master 2 / slave 18(A) / Channel 1
98	–	AS-i master 2 / slave 18(A) / Channel 2
99	–	AS-i master 2 / slave 19(A) / Channel 1
100	–	AS-i master 2 / slave 19(A) / Channel 2
101	–	AS-i master 2 / slave 20(A) / Channel 1
102	–	AS-i master 2 / slave 20(A) / Channel 2
103	–	AS-i master 2 / slave 21(A) / Channel 1
104	–	AS-i master 2 / slave 21(A) / Channel 2
105	–	AS-i master 2 / slave 22(A) / Channel 1
106	–	AS-i master 2 / slave 22(A) / Channel 2
107	–	AS-i master 2 / slave 23(A) / Channel 1
108	–	AS-i master 2 / slave 23(A) / Channel 2
109	–	AS-i master 2 / slave 24(A) / Channel 1
110	–	AS-i master 2 / slave 24(A) / Channel 2
111	–	AS-i master 2 / slave 25(A) / Channel 1
112	–	AS-i master 2 / slave 25(A) / Channel 2

Word	Setting of the device parameters	
	1 channel	2 channels
113	–	AS-i master 2 / slave 26(A) / Channel 1
114	–	AS-i master 2 / slave 26(A) / Channel 2
115	–	AS-i master 2 / slave 27(A) / Channel 1
116	–	AS-i master 2 / slave 27(A) / Channel 2
117	–	AS-i master 2 / slave 28(A) / Channel 1
118	–	AS-i master 2 / slave 28(A) / Channel 2
119	–	AS-i master 2 / slave 29(A) / Channel 1
120	–	AS-i master 2 / slave 29(A) / Channel 2
121	–	AS-i master 2 / slave 30(A) / Channel 1
122	–	AS-i master 2 / slave 30(A) / Channel 2
123	–	AS-i master 2 / slave 31(A) / Channel 1
124	–	AS-i master 2 / slave 31(A) / Channel 2

Table: Variable slave assignment for slots 5..6

41182

The following table shows the structure of the data image to set the parameter:

- Analogue channels per input slave = 4
- Analogue channels per output slave = 4

Word Offset-Nr.	Content of the transferred word for parameter setting =4 channels
n	Mx / slave m(A) / channel
n+1	Mx / slave m(A) / channel
n+2	Mx / slave m(A) / channel 1 = Mx / slave mB / channel 1
n+3	Mx / slave m(A) / channel 2 = Mx / slave mB / channel 2

Legend:

n ...	Number of 4 word blocks 1 = for setting 4 words ... 15 = for setting 60 words
x ...	1 = AS-i Master 1 2 = AS-i Master 2
m ...	Numeric part of the selected AS-i slave address

Slot 1ss/2ss – flex modules for analogue slaves

In the PROFINET-projection software, every single analogue input/output slave can be shown as separate slot. Here, the following areas apply:

- Slot 101...131 for analogue slaves at AS-i Master 1
- Slot 201...232 for analogue slaves at AS-i Master 2



In the flex module representation the first digit identifies the AS-i master the analogue slave is assigned to. The two following digits stand for the address of the analogue AS-i slave.

Example: Slot 223 = AS-i Master 2, analogue slave with address 23

These slots can contain the following modules in any combination you choose:

Module name	Description		
	slave type	Channel no.	Slave input/output
1 Channel analogue input (single or A slave)	Single or A slave	0	Input
1 Channel analogue input (B slave)	B slave	0	
2 Channels analogue input (single or A slave)	Single or A slave	0 + 1	
2 Channels analogue input (B slave)	B slave	0 + 1	
4 Channels analogue input (single or A&B slave)	Single slave or: A slave B slave	0...3 0 + 1 0 + 1	
1 Channel analogue output (single or A slave)	single or A slave	0	Output
1 Channel analogue output (B slave)	B slave	0	
2 Channels analogue output (single or A slave)	Single or A slave	0 + 1	
2 Channels analogue output (B slave)	B slave	0 + 1	
4 Channels analogue output (single or A&B slave)	Single slave or: A slave B slave	0...3 0 + 1 0 + 1	
1 Channel bidirectional analogue (single or A slave)	Single or A slave	0	Input and output
1 Channel bidirectional analogue (B slave)	B slave	0	
2 Channels bidirectional analogue (single or A slave)	single or A slave	0 + 1	
2 Channels bidirectional analogue (B slave)	B slave	0 + 1	
4 Channels bidirectional analogue (single or A&B slave)	Single slave or: A slave B slave	0...3 0 + 1 0 + 1	

Slot 7 - Inputs from AC1403/04 SPS

41632

Slot	Description	Value range	Length [Words]
7	Data from the device-internal SPS to the PROFINET PLC	Empty module = module is deactivated	0
		004 words = 4 words AC1403/04 SPS >> fieldbus PLC	4
		008 words = 8 words AC1403/04 SPS >> fieldbus PLC	8
		012 words = 12 words AC1403/04 SPS >> fieldbus PLC	12
		016 words = 16 words AC1403/04 SPS >> fieldbus PLC	16
		020 words = 20 words AC1403/04 SPS >> fieldbus PLC	20
		024 words = 24 words AC1403/04 SPS >> fieldbus PLC	24
		028 words = 28 words AC1403/04 SPS >> fieldbus PLC	28
		032 words = 32 words AC1403/04 SPS >> fieldbus PLC	32
		036 words = 36 words AC1403/04 SPS >> fieldbus PLC	36
		040 words = 40 words AC1403/04 SPS >> fieldbus PLC	40
		044 words = 44 words AC1403/04 SPS >> fieldbus PLC	44
		048 words = 48 words AC1403/04 SPS >> fieldbus PLC	48
		052 words = 52 words AC1403/04 SPS >> fieldbus PLC	52
		056 words = 56 words AC1403/04 SPS >> fieldbus PLC	56
		060 words = 60 words AC1403/04 SPS >> fieldbus PLC	60
		076 words = 76 words AC1403/04 SPS >> fieldbus PLC	76
092 words = 92 words AC1403/04 SPS >> fieldbus PLC	92		
108 words = 108 words AC1403/04 SPS >> fieldbus PLC	108		
120 words = 120 words AC1403/04 SPS >> fieldbus PLC	120		

Slot 8 - Outputs to AC1403/04 SPS

41694

Slot	Description	Value range	Length [Words]
8	Data from the PROFINET PLC to the device-internal SPS	Empty module = module is deactivated	0
		004 words = 4 words fieldbus PLC >> AC1403/04 SPS	4
		008 words = 8 words fieldbus PLC >> AC1403/04 SPS	8
		012 words = 12 words fieldbus PLC >> AC1403/04 SPS	12
		016 words = 16 words fieldbus PLC >> AC1403/04 SPS	16
		020 words = 20 words fieldbus PLC >> AC1403/04 SPS	20
		024 words = 24 words fieldbus PLC >> AC1403/04 SPS	24
		028 words = 28 words fieldbus PLC >> AC1403/04 SPS	28
		032 words = 32 words fieldbus PLC >> AC1403/04 SPS	32
		036 words = 36 words fieldbus PLC >> AC1403/04 SPS	36
		040 words = 40 words fieldbus PLC >> AC1403/04 SPS	40
		044 words = 44 words fieldbus PLC >> AC1403/04 SPS	44
		048 words = 48 words fieldbus PLC >> AC1403/04 SPS	48
		052 words = 52 words fieldbus PLC >> AC1403/04 SPS	52
		056 words = 56 words fieldbus PLC >> AC1403/04 SPS	56
		060 words = 60 words fieldbus PLC >> AC1403/04 SPS	60
		076 words = 76 words fieldbus PLC >> AC1403/04 SPS	76
092 words = 92 words fieldbus PLC >> AC1403/04 SPS	92		
108 words = 108 words fieldbus PLC >> AC1403/04 SPS	108		
120 words = 120 words fieldbus PLC >> AC1403/04 SPS	120		

8.7.4 Acyclic data

Content

Overview: Acyclic process data.....	151
Overview: acyclic data sets (DSx).....	153
Overview: System commands.....	154
Overview: AS-i master commands.....	155
Step7 programmer's notes: call acyclic services.....	156

41545

Overview: Acyclic process data

41790

The indices on slot 0, subplot 1, are used as follows:

Index [dec]	From byte no. [dec]	To byte no. [dec]	Contents	DS	Access r = read w = write	Number of words
0	–	–	reserved for system start	–	–	–
1	0	51	Read system information	DS1	r	26
30	0	239	System command request channel	–	r/w	120
31	0	239	System command reply channel	–	r	120
32	0	69	M1 digital slave inputs 1(A)...31(A) and 1B...31B (1 byte per slave) + M1 master flags (status AS-i master and exec.-ctl. flags and host flags)	DS2	r	35
33	0	149	M1 analogue slave inputs 1(A)...15(B)	DS3	r	75
34	0	159	M1 analogue slave inputs 16(A)...31(B)	DS4	r	80
35	0	63	M1 digital slave outputs 1(A)...31(A) and 1B...31B (1 byte per slave)	DS5	r/w	32
36	0	119	M1 analogue slave outputs 1(A)...15(B)	DS6	r/w	60
37	0	127	M1 analogue slave outputs 16(A)...31(B)	DS7	r/w	64
38	0	63	M1 status flags analogue outputs 1(A)...31(A) and 1B...31B	DS8	r	32
39	0	31	M1 LAS, LDS, LPF, LCE	DS9	r	16
40	0	7	M1 LPS	DS10	r	4
41	0	127	M1 current configuration data (CDI)	DS11	r	64
42	0	127	M1 projected configuration data (PCD)	DS12	r	64
43	0	63	M1 input parameter image (1 byte per slave)	DS13	r	32
44	0	63	M1 output parameter image (1 byte per slave)	DS14	r/w	32
46	0	143	M1 slave error counter, configuration error counter, AS-i cycle counter	DS15	r	72
47	0	23	M1 LCEMS, LCEAS, LDAE	DS17	r	12
62	0	239	M1 command request channel	–	r/w	120
63	0	239	M1 command reply channel	–	r	120
64	0	69	M2 digital slave inputs 1(A)...31(A) and 1B...31B (1 byte per slave) + M2 master flags (status AS-i master and exec.-ctl. flags and host flags)	DS2	r	35
65	0	149	M2 analogue slave inputs 1(A)...15(B)	DS3	r	75
66	0	159	M2 analogue slave inputs 16(A)...31(B)	DS4	r	80

Index [dec]	From byte no. [dec]	To byte no. [dec]	Contents	DS	Access r = read w = write	Number of words
67	0	63	M2 digital slave outputs 1(A)...31(A) and 1B...31B (1 byte per slave)	DS5	r/w	32
68	0	119	M2 analogue slave outputs 1(A)...15(B)	DS6	r/w	60
69	0	127	M2 analogue slave outputs 16(A)...31(B)	DS7	r/w	64
70	0	63	M2 status flags analogue outputs 1(A)...31(A) and 1B...31B	DS8	r	32
71	0	31	M2 LAS, LDS, LPF, LCE	DS9	r	16
72	0	7	M2 LPS	DS10	r	4
73	0	127	M2 current configuration data (CDI)	DS11	r	64
74	0	127	M2 projected configuration data (PCD)	DS12	r	64
75	0	63	M2 input parameter image (1 byte per slave)	DS13	r	32
76	0	63	M2 output parameter image (1 byte per slave)	DS14	r/w	32
78	0	131	M2 slave error counter, configuration error counter, AS-i cycle counter	DS15	r	66
79	0	23	M2 LCEMS, LCEAS, LDAE	DS17	r	12
94	0	239	M2 command request channel	–	r/w	120
95	0	239	M2 command reply channel	–	r	120

Legend:

DS = Acyclic data set (→ **Overview: acyclic data sets (DSx)** (→ S. [153](#)))

M1 = AS-i master 1

M2 = AS-i master 2

Overview: acyclic data sets (DSx)

Data record	Content	Access r = read w = write	Words
DS1	System information	r	26
DS2	Digital inputs of slaves 1(A)...31(A) and 1B...31B and master flags (Status AS-i master and exec.-ctl. flags and host flags)	r	36
DS3	Analogue inputs of slaves 1(A)...15(B)	r	75
DS4	Analogue inputs of slaves 16(A)...31(B)	r	80
DS5	Digital outputs of slaves 1(A)...31(A) and 1B...31B	r/w	32
DS6	Analogue outputs of slaves 1(A)...15(B)	r/w	60
DS7	Analogue outputs of slaves 16(A)...31(B)	r/w	64
DS8	Statusflags of analogue output data of slaves 1(A)...31(A) and 1B...31B	r	32
DS9	Slave lists LAS, LDS, LPF, LCE	r	16
DS10	Slave list LPS	r	4
DS11	Actual Configuration data (CDI)	r	64
DS12	Projected Configuration data (PCD)	r	64
DS13	Image of input parameter	r	32
DS14	Image of output parameter	r/w	32
DS15	Slave error counter, configuration error counter, AS-i cycle counter	r	72
DS16	n.a.	–	–
DS17	AS-i master: Error lists LCEMS, LCEAS, LDAE	r	12
DS18	Fieldbus information (only available via CODESYS)	r	19
DS19	n.a.	–	–
DS20	n.a.	–	–



Detailed information about the acyclic data sets and the command interface is given in the supplement to the device manual of the SmartSPS DataLine mit Profinet-Device-Schnittstelle (→ **Overview: User documentation for AC1403/04** (→ S. [7](#))).

Overview: System commands

41794

Comm. no. [hex]	Comm. no. [dec]	Description
0101	257	Quick setup AS-i Master 1/2
0103	259	Change the user language
0104	260	Change the display settings
0105	261	Set output control
0106	262	Set the SPS operating mode
0109	265	Set the date / time
010A	266	Configure the NTP server settings
010B	267	Read date / time / NTP settings
010C	268	Reboot the system
010D	269	Read fieldbus information (can only be executed in CODESYS!)
010F	271	Read text of an OSC entry
0110	272	Display target visualisation



Detailed information about the acyclic data sets and the command interface is given in the supplement to the device manual of the SmartSPS DataLine mit Profinet-Device-Schnittstelle (→ **Overview: User documentation for AC1403/04** (→ S. [7](#))).

Overview: AS-i master commands

41795

Comm. no. [hex]	Comm. no. [dec]	Description	Note
0001	1	Write parameters to a connected AS-i slave	
0003	3	Adopt and save currently connected AS-i slaves in the configuration  With this command the fieldbus connection is reset. The device must be rebooted!	ConfDataInp Slave → Projected Configuration Data and LDS → LPS
0004	4	Change the list of projected AS-i slaves (LPS)	
0005	5	set the operating mode of the AS-i master	
0006	6	readdress a connected AS-i slave	
0007	7	set the auto addressing mode of the AS-i master	
0009	9	change the extended ID code 1 in the connected AS-i slave	
000A	10	change PCD	
000D	13	AS-i master supply voltage, symmetry, earth fault	
0015	21	read ID string of an AS-i slave with profile S-7.4	slave profile S-7.4
001A	26	read AS-i master info	
001C	28	deactivation of the slave reset when changing to the protected mode	
0021	33	read diagnostic string of an AS-i slave with profile S-7.4	slave profile S-7.4
0022	34	read parameter string of an AS-i slave with profile S-7.4	slave profile S-7.4
0023	35	write parameter string of an AS-i slave with profile S-7.4	slave profile S-7.4
0024	36	CTT2 standard read: acyclic standard read call of an AS-i slave with CTT2 profile	CTT2 slave profile *)
0025	37	CTT2 standard write: acyclic standard write call of an AS-i slave with CTT2 profile	CTT2 slave profile *)
0026	38	CTT2 vendor specific read: acyclic manufacturer-specific read call of an AS-i slave with CTT2 profile	CTT2 slave profile *)
0027	39	CTT2 vendor specific write: acyclic manufacturer-specific write call of an AS-i slave with CTT2 profile	CTT2 slave profile *)
0040	64	CTT2 device group read: acyclic manufacturer-specific read call of an AS-i slave with CTT2 profile	CTT2 slave profile *)
0041	65	CTT2 device group write: acyclic device group write call of an AS-i slave with CTT2 profile	CTT2 slave profile *)
0042	66	CTT2 vendor specific selective read from buffer: selective standard read call of an AS-i slave with CTT2 profile	CTT2 slave profile *)
0043	67	CTT2 vendor specific selective write from buffer: selective standard write call of an AS-i slave with CTT2 profile	CTT2 slave profile *)
0044	68	CTT2 vendor specific selective read: selective manufacturer-specific read call of an AS-i slave with CTT2 profile	CTT2 slave profile *)
0045	69	CTT2 vendor specific selective write: selective manufacturer-specific write call of an AS-i slave with CTT2 profile	CTT2 slave profile *)
0046	70	CTT2 device group selective read: selective device group read call of an AS-i slave with CTT2 profile	CTT2 slave profile *)
0047	71	CTT2 device group selective write: selective device group write call of an AS-i slave with CTT2 profile	CTT2 slave profile *)
0049	73	CTT2 vendor specific exchange: manufacturer-specific data exchange with an AS-i slave with CTT2 profile	CTT2 slave profile *)

Comm. no. [hex]	Comm. no. [dec]	Description	Note
004A	74	CTT2 device group exchange: device group data exchange with an AS-i slave with CTT2 profile	CTT2 slave profile *)
004B	75	CTT2 device group selective read from buffer: manufacturer-specific read / write call of an AS-i slave with CTT2 profile	CTT2 slave profile *)
004C	76	CTT2 device group selective write from buffer: device group read / write call of an AS-i slave with CTT2 profile	CTT2 slave profile *)
0050	80	set AS-i master settings	
0051	81	Reset the error counters	

Legend:

*) ... CTT2 profiles = S-7.5.5, S-7.A.5 or S-B.A.5

CTT → **Combined transaction – Use of analogue channels in the gateway depending on the slave profile** (→ S. [129](#))



Detailed information about the acyclic data sets and the command interface is given in the supplement to the device manual of the SmartSPS DataLine mit Profinet-Device-Schnittstelle (→ **Overview: User documentation for AC1403/04** (→ S. [7](#))).

Step7 programmer's notes: call acyclic services

41711

In the projection software, standard function blocks are used for the acyclic data exchange between a PROFINET IO controller and the AC1403/04.

Siemens S7 controllers provide two standard function blocks:

- SFB52 RDREC for reading acyclic data
- SFB53 WRREC for writing acyclic data



For detailed information regarding SFB52 and SFB53: → operating instructions of the Siemens S7 controller!

8.7.5 I&M data

Content

I&M data addressing.....	157
I&M0 data	158

41469

Data structures (= data records) have been defined for identification and maintenance (I&M) in this fieldbus. I&M0 is absolutely necessary for the certification.

I&M data addressing

41468

Revision: 2011-11-16

The I&M data can be read from the device or write to the device with the following addressing (not I&M0!):

I&M	Slot / module	Sub-slot	Index *) [hex]	Length [bytes]	Read	Write	Absolutely necessary
I&M 0	0	1	AFF0	54	X	--	X
I&M 1	0	1	AFF1	54	X	X	--
I&M 2	0	1	AFF2	54	X	X	--
I&M 3	0	1	AFF3	54	X	X	--
I&M 4	0	1	AFF4	54	X	X	--

I&M0 data

41472

I&M0 provide the user with device-specific basic information. This permits a clear identification of the device with its hardware and software components as well as the manufacturer.

Date	Bytes	Content	Description
Profinet Block Header	6		Manufacturer specific
MANUFACTURER_ID	2	310	Manufacturer ID of ifm
ORDER_ID	20	e.g. AC14xx	Device order number (ASCII characters) Unneeded characters are filled with 0x20 (blank)
SERIAL_NUMBER	16		12-digit serial number of the device (ASCII) Unneeded characters are filled with 0x20 (blank)
HARDWARE_REVISION	2	e.g. AA	Device version (2 ASCII characters)
SOFTWARE_REVISION	4	e.g. V3.0.8	e.g. V3.0.8 Byte 0 = software type (char): V (= official release) Byte 1 = major version (uint8): 3 Byte 2 = minor version (uint8): 0 Byte 3 = build version (uint8): 8
REVISION_COUNTER	2	0x0001...0xFFFF	Revision counter of the device. If changes are made to the device data, the revision counter is incremented. Changes to the device data are for example the installation of a new firmware or changed device parameters.
PROFILE_ID	2	0xF600	ID for generic device
PROFILE_SPECIFIC_TYPE	2	0x0000	No profiles are supported
IM_VERSION	2	e.g. 1.1	The currently up-to-date version of the I&M data Byte 0 = major version (uint8): 1 Byte 1 = minor version (uint8): 1
IM_SUPPORTED	2	0x001E	Supported I&M data: I&M1...I&M4

8.7.6 Fieldbus alarms

Content

Process alarms	159
Diagnosis alarms	159
Step7 programmer's notes	169

41518

Depending on the compatibility mode currently active the AC1403/04 supports the following diagnosis / alarm options.

Process alarms

41767

Process alarms are used when a critical value or status occurs during the process in the plant. This can be the case e.g. when the temperature of a tank is too low or too high.

The process alarms are application-specific. For this reason, the manufacturer does not implement process alarms in this device.

Diagnosis alarms

41449

Diagnosis alarms are used where an error or event occurs in the device.

Examples:

- AS-i configuration error
- Peripheral fault on an AS-i slave



- **Slot:** 0 (corresponds to the host; in the ifm classic mapping model, this is the AC1403/04)
- **sub-slot:** 1 (others are not supported from some PROFINET-controllers).
- **Channel:** 0x08000 (fixed, others are not supported)
- **Channel property:** is always "diagnosis"
- **Alarm numbers:** are in the "Manufacturer Specific" area (0x0100 and 0x7FFF)
- All used alarms are "standard alarms" and use the "Add Channel Diagnosis Request" function on the Hilscher Alarm API.

Device diagnosis alarms

41579

Alarm type ID	Description	Slot / sub-slot / channel	Alarm parameter
0x0100	internal device system error cause of error → alarm parameter	0 / 1 / 0x8000	cause of error
0x0101	excess temperature: temperature inside the device has exceeded the permitted max. value of 80 ° celsius.	0 / 1 / 0x8000	device temperature
0x0104	the gateway mode is deactivated	0 / 1 / 0x8000	--

AS-i diagnosis alarms

41541

Alarm type ID	Description	Slot / sub-slot / channel	Alarm parameters
0x0200	internal system error of an AS-i master	M / 1 / 0x8000	master number, cause of error
0x0202	AS-i master was set to the projection mode	M / 1 / 0x8000	master number
0x0203	new slave 0 was detected	M / 1 / 0x8000	master number
0x0204	earth fault was detected	M / 1 / 0x8000	master number, symmetry
0x0207	22.5 V AS-i power failure was detected (classic ASi power)	M / 1 / 0x8000	master number
0x0208	19 V AS-i power failure was detected (Power24)	M / 1 / 0x8000	master number
0x03(SLA)	configuration error, too many slaves	M / 1 / 0x8000	master number, slave address
0x04(SLA)	configuration error, slave missing	M / 1 / 0x8000	master number, slave address
0x05(SLA)	configuration error, slave has wrong profile	M / 1 / 0x8000	master number, slave address
0x06(SLA)	periphery fault	M / 1 / 0x8000	master number, slave address
0x0701...0x071F	double addressing fault	M / 1 / 0x8000	master number, slave address

Legend:

M	master no.	1 bit	0 = AS-i master 1 1 = AS-i master 2
SLA	slave address	1 byte	slaves 1(A)...31(A): 0x01...0x1F = 1...31 slaves 1B...31B: 0x21...0x3F = 33...63

Configuration and periphery faults are signalled in slot 1 for AS-i master 1 and in slot 2 for AS-i master 2. The subslot is always 1, the channel always 0x8000.

The alarm type ID indicates ...

- the type of error occurred (with the high byte of the alarm type ID)
- the slave address causing the error (with the low byte of the alarm type ID).

If there is more than one slave address causing an error, several alarms are sent. The alarms are independent of each other and remain set as long as the reason for the alarm exists.

The following tables list the complete assignment of alarm type ID by error type and slave address.

Diagnosis data of the alarms

Content

Alarm 0x0100 – internal device system error	161
Alarm 0x0101 – excess temperature	161
Alarm 0x0104 – Manual output control was activated	161
Alarm 0x0200 – internal system error in the AS-i master	162
Alarm 0x0202 – AS-i master set to the projection mode	162
Alarm 0x0203 – new slave 0 was detected	162
Alarm 0x0204 – earth fault detected	162
Alarm 0x0207 – 22.5 V AS-i power failure detected	163
Alarm 0x0208 – 19 V AS-i power failure detected	163
Alarm 0x03ss – configuration error, too many slaves	164
Alarm 0x04ss – configuration error, slave is missing	165
Alarm 0x05ss – configuration error, slave has an incorrect profile	166
Alarm 0x06ss – periphery fault	167
Alarm 0x07ss – double addressing fault	168

41463

After an incoming alarm the data for the diagnosis is only available in the Profinet device until the outgoing alarm is received.

Below you will find a description of which diagnosis data is available in the event of an alarm.

Alarm 0x0100 – internal device system error

41562

Offset Word no.	Bit															
	15	14	13	12	11	10	9	8	7	6	5	4	3	2	1	0
0	cause of error															

Please ask your AS-i specialist for more details.

Alarm 0x0101 – excess temperature

41561

Offset Word no.	Bit															
	15	14	13	12	11	10	9	8	7	6	5	4	3	2	1	0
0	device temperature in [°C]															

Alarm 0x0104 – Manual output control was activated

41566

Offset Word no.	Bit															
	15	14	13	12	11	10	9	8	7	6	5	4	3	2	1	0
0	Manual output control was recognised															

Alarm 0x0200 – internal system error in the AS-i master

41565

Offset Word no.	Bit															
	15	14	13	12	11	10	9	8	7	6	5	4	3	2	1	0
0	reserved															M
1	cause of error															

Legend:

M	master no.	1 bit	0 = AS-i master 1 1 = AS-i master 2
---	------------	-------	--

Please ask your AS-i specialist for more details.

Alarm 0x0202 – AS-i master set to the projection mode

41564

Offset Word no.	Bit															
	15	14	13	12	11	10	9	8	7	6	5	4	3	2	1	0
0	reserved															M

Legend:

M	master no.	1 bit	0 = AS-i master 1 1 = AS-i master 2
---	------------	-------	--

Alarm 0x0203 – new slave 0 was detected

41557

Offset Word no.	Bit															
	15	14	13	12	11	10	9	8	7	6	5	4	3	2	1	0
0	reserved															M

Legend:

M	master no.	1 bit	0 = AS-i master 1 1 = AS-i master 2
---	------------	-------	--

Alarm 0x0204 – earth fault detected

41556

Offset Word no.	Bit															
	15	14	13	12	11	10	9	8	7	6	5	4	3	2	1	0
0	reserved															M
1	Symmetry															

Legend:

M	master no.	1 bit	0 = AS-i master 1 1 = AS-i master 2
---	------------	-------	--

Alarm 0x0207 – 22.5 V AS-i power failure detected

41555

Supply voltage of the AS-i master dropped below 22.5 V.

Offset Word no.	Bit															
	15	14	13	12	11	10	9	8	7	6	5	4	3	2	1	0
0	reserved															M

Legend:

M	master no.	1 bit	0 = AS-i master 1 1 = AS-i master 2
---	------------	-------	--

Alarm 0x0208 – 19 V AS-i power failure detected

41560

Supply voltage of the AS-i master dropped below 19 V.

Offset Word no.	Bit															
	15	14	13	12	11	10	9	8	7	6	5	4	3	2	1	0
0	reserved															M

Legend:

M	master no.	1 bit	0 = AS-i master 1 1 = AS-i master 2
---	------------	-------	--

Alarm 0x03ss – configuration error, too many slaves

41559

Alarm type ID		Slave address
[dec]	[hex]	
769	0301	1(A)
770	0302	2(A)
771	0303	3(A)
772	0304	4(A)
773	0305	5(A)
774	0306	6(A)
775	0307	7(A)
776	0308	8(A)
777	0309	9(A)
778	030A	10(A)
779	030B	11(A)
780	030C	12(A)
781	030D	13(A)
782	030E	14(A)
783	030F	15(A)
784	0310	16(A)
785	0311	17(A)
786	0312	18(A)
787	0313	19(A)
788	0314	20(A)
789	0315	21(A)
790	0316	22(A)
791	0317	23(A)
792	0318	24(A)
793	0319	25(A)
794	031A	26(A)
795	031B	27(A)
796	031C	28(A)
797	031D	29(A)
798	031E	30(A)
799	031F	31(A)

Alarm type ID		Slave address
[dec]	[hex]	
801	0321	1B
802	0322	2B
803	0323	3B
804	0324	4B
805	0325	5B
806	0326	6B
807	0327	7B
808	0328	8B
809	0329	9B
810	032A	10B
811	032B	11B
812	032C	12B
813	032D	13B
814	032E	14B
815	032F	15B
816	0330	16B
817	0331	17B
818	0332	18B
819	0333	19B
820	0334	20B
821	0335	21B
822	0336	22B
823	0337	23B
824	0338	24B
825	0339	25B
826	033A	26B
827	033B	27B
828	033C	28B
829	033D	29B
830	033E	30B
831	033F	31B

Alarm 0x04ss – configuration error, slave is missing

41558

Alarm type ID		Slave address
[dec]	[hex]	
1025	0401	1(A)
1026	0402	2(A)
1027	0403	3(A)
1028	0404	4(A)
1029	0405	5(A)
1030	0406	6(A)
1031	0407	7(A)
1032	0408	8(A)
1033	0409	9(A)
1034	040A	10(A)
1035	040B	11(A)
1036	040C	12(A)
1037	040D	13(A)
1038	040E	14(A)
1039	040F	15(A)
1040	0410	16(A)
1041	0411	17(A)
1042	0412	18(A)
1043	0413	19(A)
1044	0414	20(A)
1045	0415	21(A)
1046	0416	22(A)
1047	0417	23(A)
1048	0418	24(A)
1049	0419	25(A)
1050	041A	26(A)
1051	041B	27(A)
1052	041C	28(A)
1053	041D	29(A)
1054	041E	30(A)
1055	041F	31(A)

Alarm type ID		Slave address
[dec]	[hex]	
1057	0421	1B
1058	0422	2B
1059	0423	3B
1060	0424	4B
1061	0425	5B
1062	0426	6B
1063	0427	7B
1064	0428	8B
1065	0429	9B
1066	042A	10B
1067	042B	11B
1068	042C	12B
1069	042D	13B
1070	042E	14B
1071	042F	15B
1072	0430	16B
1073	0431	17B
1074	0432	18B
1075	0433	19B
1076	0434	20B
1077	0435	21B
1078	0436	22B
1079	0437	23B
1080	0438	24B
1081	0439	25B
1082	043A	26B
1083	043B	27B
1084	043C	28B
1085	043D	29B
1086	043E	30B
1087	043F	31B

Alarm 0x05ss – configuration error, slave has an incorrect profile

41527

Alarm type ID		Slave address
[dec]	[hex]	
1281	0501	1(A)
1282	0502	2(A)
1283	0503	3(A)
1284	0504	4(A)
1285	0505	5(A)
1286	0506	6(A)
1287	0507	7(A)
1288	0508	8(A)
1289	0509	9(A)
1290	050A	10(A)
1291	050B	11(A)
1292	050C	12(A)
1293	050D	13(A)
1294	050E	14(A)
1295	050F	15(A)
1296	0510	16(A)
1297	0511	17(A)
1298	0512	18(A)
1299	0513	19(A)
1300	0514	20(A)
1301	0515	21(A)
1302	0516	22(A)
1303	0517	23(A)
1304	0518	24(A)
1305	0519	25(A)
1306	051A	26(A)
1307	051B	27(A)
1308	051C	28(A)
1309	051D	29(A)
1310	051E	30(A)
1311	051F	31(A)

Alarm type ID		Slave address
[dec]	[hex]	
1313	0521	1B
1314	0522	2B
1315	0523	3B
1316	0524	4B
1317	0525	5B
1318	0526	6B
1319	0527	7B
1320	0528	8B
1321	0529	9B
1322	052A	10B
1323	052B	11B
1324	052C	12B
1325	052D	13B
1326	052E	14B
1327	052F	15B
1328	0530	16B
1329	0531	17B
1330	0532	18B
1331	0533	19B
1332	0534	20B
1333	0535	21B
1334	0536	22B
1335	0537	23B
1336	0538	24B
1337	0539	25B
1338	053A	26B
1339	053B	27B
1340	053C	28B
1341	053D	29B
1342	053E	30B
1343	053F	31B

Alarm 0x06ss – periphery fault

41526

Alarm type ID		Slave address
[dec]	[hex]	
1537	0601	1(A)
1538	0602	2(A)
1539	0603	3(A)
1540	0604	4(A)
1541	0605	5(A)
1542	0606	6(A)
1543	0607	7(A)
1544	0608	8(A)
1545	0609	9(A)
1546	060A	10(A)
1547	060B	11(A)
1548	060C	12(A)
1549	060D	13(A)
1550	060E	14(A)
1551	060F	15(A)
1552	0610	16(A)
1553	0611	17(A)
1554	0612	18(A)
1555	0613	19(A)
1556	0614	20(A)
1557	0615	21(A)
1558	0616	22(A)
1559	0617	23(A)
1560	0618	24(A)
1561	0619	25(A)
1562	061A	26(A)
1563	061B	27(A)
1564	061C	28(A)
1565	061D	29(A)
1566	061E	30(A)
1567	061F	31(A)

Alarm type ID		Slave address
[dec]	[hex]	
1569	0621	1B
1570	0622	2B
1571	0623	3B
1572	0624	4B
1573	0625	5B
1574	0626	6B
1575	0627	7B
1576	0628	8B
1577	0629	9B
1578	062A	10B
1579	062B	11B
1580	062C	12B
1581	062D	13B
1582	062E	14B
1583	062F	15B
1584	0630	16B
1585	0631	17B
1586	0632	18B
1587	0633	19B
1588	0634	20B
1589	0635	21B
1590	0636	22B
1591	0637	23B
1592	0638	24B
1593	0639	25B
1594	063A	26B
1595	063B	27B
1596	063C	28B
1597	063D	29B
1598	063E	30B
1599	063F	31B

Alarm 0x07ss – double addressing fault

41525

Alarm type ID		Slave address
[dec]	[hex]	
1793	0701	1
1794	0702	2
1795	0703	3
1796	0704	4
1797	0705	5
1798	0706	6
1799	0707	7
1800	0708	8
1801	0709	9
1802	070A	10
1803	070B	11
1804	070C	12
1805	070D	13
1806	070E	14
1807	070F	15
1808	0710	16
1809	0711	17
1810	0712	18
1811	0713	19
1812	0714	20
1813	0715	21
1814	0716	22
1815	0717	23
1816	0718	24
1817	0719	25
1818	071A	26
1819	071B	27
1820	071C	28
1821	071D	29
1822	071E	30
1823	071F	31

Step7 programmer's notes

41706

Diagnostics alarm procedure:

1. As soon as a device has detected a diagnostics alarm, the alarm is automatically forwarded to the fieldbus controller.
2. When a diagnostics alarm arrives in the fieldbus controller, an interrupt of the cyclic program (OB1) processing is automatically generated.
3. In this case the Simatic operating system calls the OB82 (diagnostics alarm OB) which allows specific alarm processing.

The incoming and outgoing diagnostics alarms are signalled via OB82.

- ▶ Create OB82 (can be empty).
- > If OB82 does not exist, the S7 goes into the STOP state at each alarm.
- ▶ The LED [SF] on the S7 starts to light at the first incoming alarm and goes out with the last outgoing alarm.

8.8 OSC messages

Content

OSC messages: System	170
OSC messages: AS-i 1 / AS-i 2.....	171

41730

This section contains information about the messages for events, warnings and faults of the AC1403/04.

8.8.1 OSC messages: System

41734

Message	Type	Corrective measures
An internal device error was detected <Fehlernummer>	Error	► Note the message and contact the ifm service center
Permitted temperature limit value inside the device was exceeded (<xxx.x> °C)	Warning	► Check thermal conditions of the system environment
First operation after delivery	Event	not necessary
The output control was set to <Gateway,manuell,SPS>	Event	not necessary
System power-up completed, <SW-Version>	Event	not necessary
A system reset was requested manually	Event	not necessary
The user-specific message history was deleted.	Event	not necessary
The device was reset to factory settings via <HMI, Feldbus>.	Event	not necessary
PLC used for more than 10 hours.	Event	not necessary
The project <Name> was loaded.	Event	not necessary
The PLC was set to the operating mode <Projektierungsmodus, geschützter Betrieb>.	Event	not necessary
The firmware was updated from <FW-Version> to version <FW-Version>.	Event	not necessary
The settings of the fieldbus interface were modified	Event	not necessary
The fieldbus connection was established	Event	not necessary
The fieldbus connection was aborted	Event	not necessary
The IP settings of the configuration interface were changed	Event	not necessary

8.8.2 OSC messages: AS-i 1 / AS-i 2

41735

Message	Type	Corrective measures
System errors: AS-i master <1,2>	Error	<ul style="list-style-type: none"> ▶ Reboot the device If the error occurs again: ▶ Note the message and contact the ifm service center!
Earth fault: AS-i <1,2>	Error	<ul style="list-style-type: none"> ▶ Check for earth fault of AC1403/04
Incorrect profile: AS-i <1,2>, slave <1(A)..31(A), 1B..31B> with profile <S-x.x.x> expected, but <S-y.y.y> found.	Error	<ul style="list-style-type: none"> ▶ Check profile of the AS-i slave
Config error: AS-i <1,2>, slave <1(A)..31(A), 1B..31B> with the profile <S-x.x.x> missing	Error	<ul style="list-style-type: none"> ▶ Check connections of the AS-i slave ▶ Reconnect AS-i slave
Config error: AS-i <1,2>, slave <1(A)..31(A), 1B..31B> with the profile <S-x.x.x> is available but not projected	Error	<ul style="list-style-type: none"> ▶ Carry out projection process ([Quick setup] > [Project all])
Protocol error: AS-i <1, 2>, slave <1(A)..31(A), 1B..31B> no data transmission	Error	<ul style="list-style-type: none"> ▶ Improve the transmission quality on the AS-i line
Double address detected: AS-i <1, 2>, slave <1(A)..31(A), 1B..31B>	Error	<ul style="list-style-type: none"> ▶ Remove an AS-i slave with a double address from the AS-i network ▶ Readdress the remaining AS-i slave ▶ Reconnect removed AS-i slave to the AS-i network
The automatic addressing is not activated for AS-i <1,2>.	Warning	<ul style="list-style-type: none"> ▶ Activate automatic addressing ([AS-i1]/[AS-i2] > [Master setup])
A voltage drop of 19.0 V was detected on AS-i master <1,2>	Warning	<ul style="list-style-type: none"> ▶ Check voltage supply of the device and replace if necessary
A voltage drop of 22.5 V was detected on AS-i master <1,2>	Warning	<ul style="list-style-type: none"> ▶ Check voltage supply of the device and replace if necessary
Increased message error rate: AS-i <1, 2>, slave <1(A)..31(A), 1B..31B>	Warning	<ul style="list-style-type: none"> ▶ Improve the transmission quality on the AS-i line
Peripheral fault: AS-i <1, 2>, slave <1(A)..31(A), 1B..31B>	Warning	<ul style="list-style-type: none"> ▶ Check displayed AS-i slave
AS-i slave with address 0 cannot be automatically readdressed (wrong profile)	Warning	<ul style="list-style-type: none"> ▶ Activate automatic addressing ([AS-i1]/[AS-i2] > [Master setup])
Manual output change: AS-i <1, 2>, slave <1(A)..31(A), 1B..31B>, value: <0..F, 0..32768>	Event	not necessary
Manual parameter change: AS-i <1, 2>, slave <1(A)..31(A), 1B..31B>, value: <0..F, 0..32768>	Event	not necessary
AS-i master <1,2> was switched to the <geschützten Betrieb, Projektierungsmodus>	Event	not necessary
AS-i projection process was carried out.	Event	not necessary
AS-i slave with the address 0 was detected	Event	not necessary

9 Index

A

Acyclic data.....	151
Additional functions.....	37
Address assignment in Ethernet networks.....	114
Adjust device cycle.....	68
Adopt the system time of the PC.....	74
Alarm 0x0100 – internal device system error.....	161
Alarm 0x0101 – excess temperature.....	161
Alarm 0x0104 – Manual output control was activated.....	161
Alarm 0x0200 – internal system error in the AS-i master.....	162
Alarm 0x0202 – AS-i master set to the projection mode.....	162
Alarm 0x0203 – new slave 0 was detected.....	162
Alarm 0x0204 – earth fault detected.....	162
Alarm 0x0207 – 22.5 V AS-i power failure detected.....	163
Alarm 0x0208 – 19 V AS-i power failure detected.....	163
Alarm 0x03ss – configuration error, too many slaves.....	164
Alarm 0x04ss – configuration error, slave is missing.....	165
Alarm 0x05ss – configuration error, slave has an incorrect profile.....	166
Alarm 0x06ss – periphery fault.....	167
Alarm 0x07ss – double addressing fault.....	168
Analogue input.....	52
Analogue output.....	53
Appendix.....	111
Approval tests / certifications.....	111
Arrow and function keys.....	12
Arrow keys.....	15
AS-i 1 / AS-i 2.....	47
AS-i slaves.....	52
Diagnosis.....	50
Master setup.....	48
AS-i diagnosis alarms.....	160
AS-i master.....	117
AS-i slaves.....	121

B

Behaviour of the settings upon firmware update.....	99
Binary field.....	31
Button.....	22

C

Carry out a projection adaptation.....	49
Change an AS-i slave address.....	56
Change an AS-i slave parameter output.....	56
Change the analogue output values manually.....	55
Change the basic settings of the device.....	97
Change the digital output values manually.....	54
Change the Extended ID1 of the AS-i slave.....	57
Checkbox.....	22
Clone device configuration.....	75
CODESYS SPS.....	12
Combined transaction – Use of analogue channels in the gateway depending on the slave profile.....	129
Configuration data (CDI) of the slaves (slave profiles).....	123
Configuration interface.....	96
Configuration interfaces.....	
Connection concepts.....	115
Configuration of the analogue channels in the slots 5 ... 6.....	143
Configure the IP parameters automatically.....	82

Configure the IP parameters manually.....	82
Confirmation message.....	29
Connect and address AS-i slaves.....	103
Connect the device to the periphery.....	96
Connection via Ethernet network.....	116
Control a single SPS application.....	61
Control instance of the AS-i outputs.....	106
Control of the graphical user interface.....	14
Control SPS applications.....	62
Cyclic data.....	135

D

Description of the control elements.....	20
Description of the extended ID code 1.....	124
Description of the extended ID code 2.....	125
Description of the ID code (selection).....	124
Description of the IO code for digital slaves.....	124
Device diagnosis alarms.....	160
Diagnosis alarms.....	159
Diagnosis data of the alarms.....	161
Digital input.....	52
Digital output.....	53
Direct connection.....	115
Disconnect from web interface.....	35
Display.....	12
Display and reset performance data.....	51
Display and reset the error counters.....	50
Display diagnostic data.....	79, 89
Display elements.....	12, 112
Display I&M information.....	85
Display information about SPS projects.....	60
Display module configuration.....	87
Display PROFINET data.....	86
Display the error statistics of the AS-i slaves.....	50
Display the input/output data of the AS-i slave.....	52
Display the status of the CODESYS SPS.....	60
Display the voltage supply analysis.....	51
Download GSDML file.....	87

E

Enable/Disable the device-internal PLC.....	67
Ethernet configuration interfaces.....	13
EtherNet/IP interface.....	96
Example.....	17
Exchange AS-i slave.....	104
Explanation of Symbols.....	6
Export device configuration.....	76
Extended ID code 2 for analogue slaves with profile 7.3.x.....	125
Extended ID code 2 for analogue slaves with profile 7.4.x.....	125

F

Fieldbus alarms.....	159
Fieldbus parameters.....	131
Fieldbus Profinet.....	131
Fieldbus status.....	106
Firmware update from SD card.....	100
Firmware update via the web interface.....	101
Free slave addresses.....	
colour code + symbols.....	28
Function keys.....	15

G

General	32
General safety instructions	8
GSDML file	134

H

Housing	112
---------------	-----

I

I&M data	157
I&M data addressing	157
I&M0 data	158
ifm system solutions	90
Import device configuration	77
Information concerning the device	11
Install multi app	94
Install single/basic app	93
Intended use	10
Interfaces	13, 80, 113
Configuration interface 2	83
Konfigurationsschnittstelle 1	81
PROFINET interface	84

L

Legal and copyright information	5
List	23
Locate error sources	107

M

Mapping of the digital input/output data	139
Master flags	120
Meaning of the colour combinations	28
Meaning of the colour combinations (example configuration error type 2)	26
Menu	36
Menu functions	37
Menu navigation	16
Menu view	16
Message types	107
Modification history	7

N

Navigate on a page	19
Navigation aids	17
Notes on ifm system solutions	91
Notes on IP settings	81
Numerical field	30

O

Online diagnosis function	107
Online Support Center (OSC)	108
Operating elements	12
Operating instructions	33
Operating mode of the AS-i master	106
Operating modes of the AS-i master	118
Operation	14, 112
Optional	
adjust the IP parameters	101
switch the language with a key combination	69

OSC

Show message history	110
View current error messages	109
OSC messages	170
AS-i 1 / AS-i 2	171
System	170
Overview	11
acyclic data sets (DSx)	153
Acyclic process data	151
AS-i master commands	155
System commands	154
User documentation for AC1403/04	7
Overview of free slave addresses	27
Overview of slave states	25

P

Page view	19
Parameter data	132
Parameter input	53
Parameters	
Compact Mode	132
Flexible mode	134
Permitted use	10
PLC	
Diagnosis	64
Information	60
Settings	61
Power supply connections	112
Preliminary note	5
Preparations	100, 101
Process alarms	159
Profiles of AS-i slaves	122
PROFINET	
Diagnosis	89
Information	85
Setup	88
PROFINET fieldbus interface	13
PROFINET interface	88
PROFINET modules	135
Compact Mode	136
Flexible mode	135
Programmable Logic Controller (PLC)	113
Prohibited use	10
Projection mode	118
Protected mode	118
Purpose of the document	5

Q

Quick setup	38
Access the device via QR code	42
Address the AS-i slaves connected to AS-i Master 1	45
Address the AS-i slaves connected to AS-i Master 2	46
Configure the operating mode of the AS-i masters	40
Configure the output access	41
Configure the PROFINET interface	42
Project AS-i networks	39
Set the configuration interface 2	44
Set the Konfigurationsschnittstelle 1	43

R

Reboot the device	100, 102
Recommended browsers	32
Remote access	32

Required accessories	13
Required background knowledge	8

S

Safety instructions	8
SD card slot	13
Set Ethernet configuration interfaces	104
Set the behaviour of the display	70
Set the monitoring functions of the AS-i master	49
Set the operating mode of the AS-i master	48
Set the output access	66
Set the system time	71
Set the system time manually	72
Set up Profinet	103
Setup	96
Show AS-i slave information	55
Show Ethernet information	83
Show information about installed ifm apps	92
Show memory used	64
Show target visualisation	63
Show version information	65
Slave profiles for slaves with combined transaction	129
Slave selector	24
Slave status	
colour code + symbols	26
Slot 1 – Digital inputs/outputs of single/A slaves, AS-i master 1	137
Slot 1ss/2ss – flex modules for analogue slaves	148
Slot 2 – Digital inputs/outputs of single/A slaves, AS-i master 2	137
Slot 3 – Digital inputs/outputs of B slaves, AS-i master 1	138
Slot 4 – Digital inputs/outputs of B slaves, AS-i master 2	138
Slot 5 – Analogue input data	141
Slot 6 – Analogue output data	142
Slot 7 - Inputs from AC1403/04 SPS	149
Slot 8 - Outputs to AC1403/04 SPS	150
Start screen	36
Status LEDs	106
Start screen 'Basic settings'	97
Start the recovery mode	100, 101
Status LED	105
Basic device	105
Fieldbus PROFINET	105
Status LEDs	12
Status of the web interface	106
Step7 programmer's notes	169
call acyclic services	156
Store diagnostic protocol	78
Structure of the slave profile	123
Switch operating modes	119
Switch the menu language	69
Synchronise the system time with an NTP server	73
System	58
Diagnosis	79
Information	65
Programmable Logic Controller (PLC)	59
Setup	66
System description	9
System reset	78

T

Tab menu/Tab	21
Table	

Fixed slave assignment for slots 5..6	144
Master flags	140
Variable slave assignment for slots 5..6	147
Tampering with the unit	8
Technical data	112
Troubleshooting	105
Types of ifm system solutions	91

U

Uninstall ifm apps	95
Update ifm apps	95
Update the firmware	100, 102
Update the firmware of the device	99
Use navigation aids	19

V

Valid combinations IO code / ID code / extended ID code 2	126
---	-----

W

Web interface	
Access	33
Navigation	33
Password protection	34
Web interface login	34