



Operating instructions
RF-identification system

GB

DTI424
DTI425

Read/write head



Contents

1	Preliminary note	3
1.1	Symbols used	3
1.2	Warnings used	3
1.3	Legal and copyright information	3
2	Safety instructions	4
3	Intended use	5
4	Items supplied	6
5	Function	7
5.1	ID tags	7
5.2	Device overview	7
5.3	IO-Link	7
6	Installation	8
6.1	Notes on the unit installation	8
6.2	Avoiding interference	8
6.3	Mechanical design	8
6.4	Install device	9
6.5	Mounting distances	9
6.6	Positioning of the ID tags	10
7	Electrical connection	12
7.1	Wiring	12
8	Operating and display elements	13
9	Parameter setting	14
9.1	Parameter	14
9.1.1	Data block size	14
9.1.2	Data alignment	14
9.1.3	Data hold time	14
9.1.4	Address for automatic read/write	15
9.1.5	Data length for automatic read/write	15
9.2	Status bits	15
10	Operation	17
10.1	Deactivate internal antenna	17
10.2	Operating mode Read UID	17
10.3	Operating mode Auto read data	18
10.4	Operating mode Auto write data	19
10.5	Operating mode Read data	20
10.5.1	Example successful reading of data	22
10.5.2	Example unsuccessful reading of data	23
10.6	Operating mode Write data	24
10.6.1	Example successful writing of data	25
10.6.2	Example unsuccessful writing of data	26
10.7	Error values in the process data input	28
11	Maintenance, repair and disposal	29
12	Approvals/standards	30
	Glossary	31

1 Preliminary note

You will find instructions, technical data, approvals and further information using the QR code on the unit / packaging or at www.ifm.com.

1.1 Symbols used

- ✓ Requirement
- ▶ Instructions
- ▷ Reaction, result
- [...] Designation of keys, buttons or indications
- Cross-reference
-  Important note
Non-compliance may result in malfunction or interference.
-  Information
Supplementary note

1.2 Warnings used

ATTENTION

Warning of damage to property

1.3 Legal and copyright information

© All rights reserved by ifm electronic gmbh. No part of these instructions may be reproduced and used without the consent of ifm electronic gmbh.

All product names, pictures, companies or other brands used on our pages are the property of the respective rights owners.

2 Safety instructions

General

- The unit described is a subcomponent for integration into a system.
 - The system architect is responsible for the safety of the system.
 - The system architect undertakes to perform a risk assessment and to create documentation in accordance with legal and normative requirements to be provided to the operator and user of the system. This documentation must contain all necessary information and safety instructions for the operator, the user and, if applicable, for any service personnel authorised by the architect of the system.
- Read this document before setting up the product and keep it during the entire service life.
- The product must be suitable for the corresponding applications and environmental conditions without any restrictions.
- Only use the product for its intended purpose (→ → Intended use).
- If the operating instructions or the technical data are not adhered to, personal injury and/or damage to property may occur.
- The manufacturer assumes no liability or warranty for any consequences caused by tampering with the product or incorrect use by the operator.
- Installation, electrical connection, set-up, operation and maintenance of the product must be carried out by qualified personnel authorised by the machine operator.
- Protect units and cables against damage.

Radio equipment

In general, radio equipment must not be used in the vicinity of petrol stations, fuel depots, chemical plants or blasting operations.

- ▶ Do not transport and store any flammable gases, liquids or explosive substances near the unit.

Interference of electronic and medical devices

Operation can affect the function of electronic devices that are not correctly shielded.

- ▶ Disconnect the device in the vicinity of medical equipment.
- ▶ Contact the manufacturer of the corresponding device in case of any interference.

3 Intended use

The read/write head reads and writes **ID tags** without contact.

The data is made available as process data via the **IO-Link** interface.

4 Items supplied

- Read/write head
- 2x hexagonal nut



The device is supplied without installation and connection accessories.

Available accessories: www.ifm.com.

The optimum function is not ensured when using components from other manufacturers.

5 Function

5.1 ID tags

The **ID tags** are passively operated without a battery. The energy required for operation is provided by the read/write head.

The energy is provided via an inductive coupling. The integrated antenna coil in the read/write head generates a magnetic field which partly penetrates the antenna coil of the ID tag. A voltage is generated by induction that supplies the data carrier with energy.

The device supports ID tags according to ISO 15693.

5.2 Device overview

DTI424

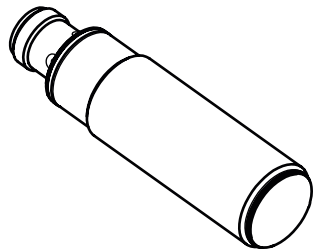
	Article number:	DTI424
	Function:	Read/write head
	Type designation:	DTRHF GBRWIOUS03
	Type:	M18, flush mountable

DTI425

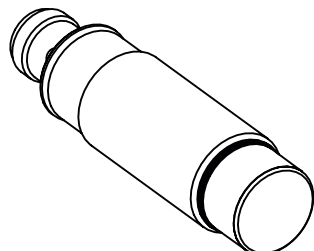
	Article number:	DTI425
	Function:	Read/write head
	Type designation:	DTRHF GNRWIOUS03
	Type:	M18, non flush mountable

5.3 IO-Link



This unit has an IO-Link communication interface which enables direct access to process and diagnostic data. In addition it is possible to set the parameters of the unit while it is in operation. Operation of the unit via the IO-Link interface requires an IO-Link master.

With a PC, suitable IO-Link software and an IO-Link adapter cable, communication is possible while the system is not in operation.

The **IODD** required to configure the unit is available at www.ifm.com.

6 Installation

6.1 Notes on the unit installation

-  When mounting several RFID units adhere to the minimum distances between the systems.
-  Flush mounting of a read/write head in metal reduces the read/write distance.
-  Device performance can be affected if positioned in the immediate vicinity of powerful HF emission sources such as welding transformers or converters.

6.2 Avoiding interference

The device generates a modulated electrical field with a frequency of 13.56 MHz.

Avoid interference with data communication:

- ▶ Do not operate any devices in the vicinity that use the same frequency band.
- ▷ Such devices are for example frequency converters and switched-mode power supplies.

If there are other devices in the same frequency band in the vicinity:

- ▶ The mounting distances between the devices should be as large as possible.
- ▶ Use the devices in alternating operation.
- ▶ Switch the HF field of the device on/off.

6.3 Mechanical design

DTI424

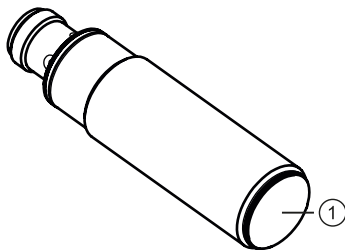

Fig. 1: DTI424

1 Sensing face

DTI425

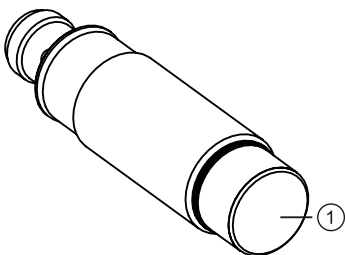

Fig. 2: DTI425

1 Sensing face

6.4 Install device

► Fix the device using the supplied nuts (M18).

DTI424

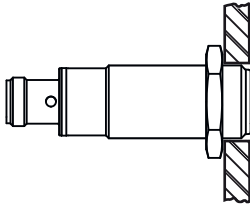

Fig. 3: Flush mounting

DTI425

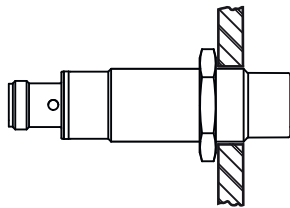
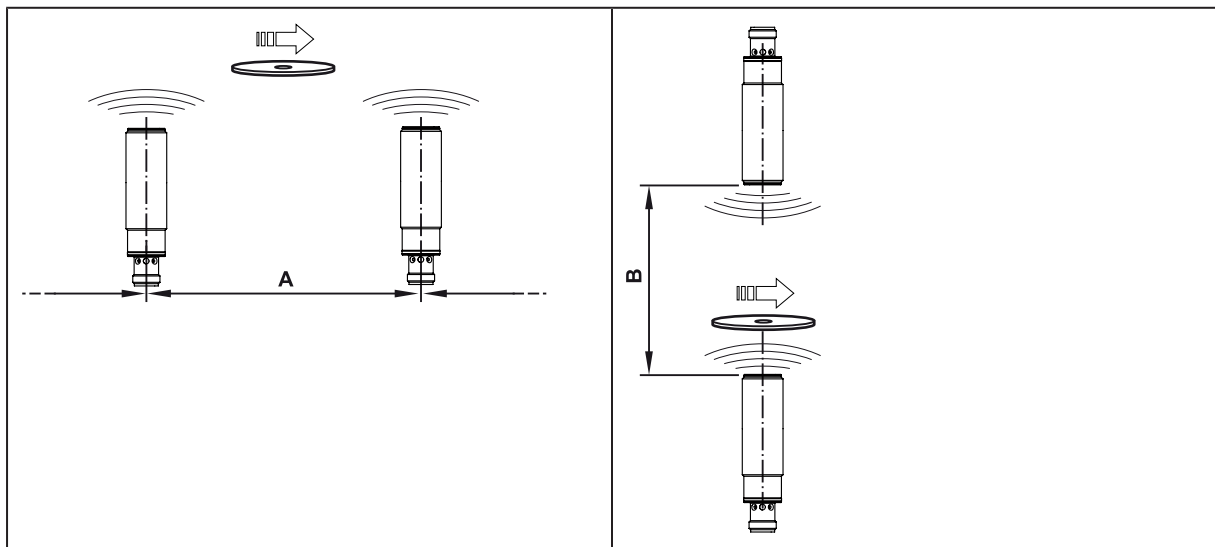

Fig. 4: Non flush mounting

6.5 Mounting distances

DTI424



Operating mode	Distance side (A)	Distance front (B)
For reading and writing	≥ 60 mm	≥ 100 mm

DTI425

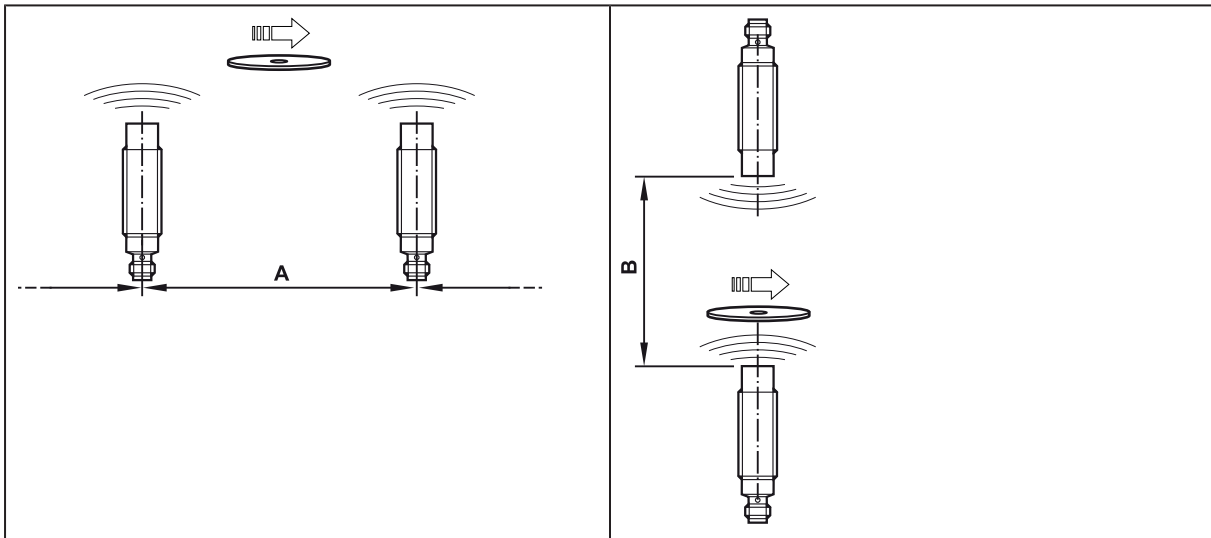



Operating mode	Distance side (A)	Distance front (B)
For reading and writing	≥ 90 mm	≥ 180 mm

6.6 Positioning of the ID tags

- 

The read/write heads are marked with an antenna symbol on the sensing face. It designates the middle of the integrated antenna coil and has to correspond with the middle of the ID tag.

 - ▶ Align the axes of the RFID device and the ID tag in the same way.
- 

For installation in or on metal use the ID tags provided for this purpose.
- 

Position the ID tag in the area of the sensing face. When doing so, the angle of aperture and the operating distance must be adhered to (→ Data sheet of the device).

DTI424

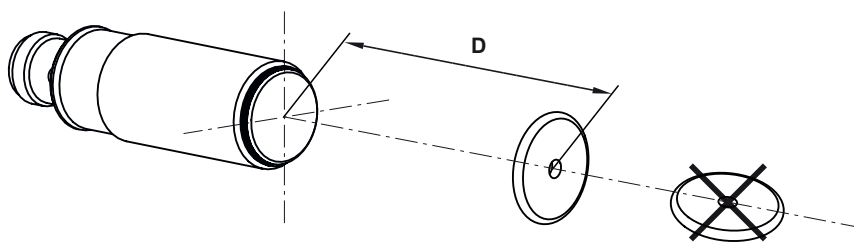



Fig. 5: Position the ID tag

- ▶ Align the ID tag on the central axis of the antenna of the unit.

ID tag	Type	Distance read/write head (D) in plastic
E80371		16 mm

- 

The indications in the table apply to static read/write operations.

DTI425

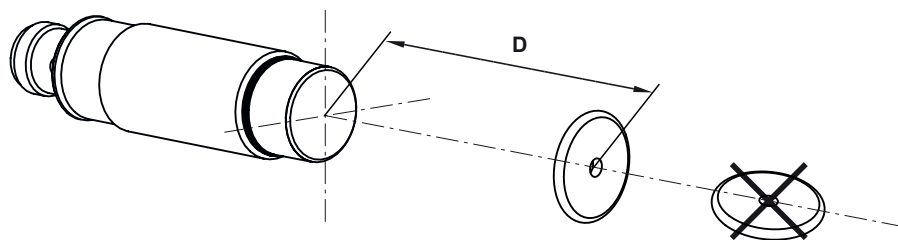
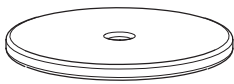

Fig. 6: Position the ID tag

► Align the ID tag on the central axis of the antenna of the unit.

ID tag	Type	Distance read/write head (D) in plastic
E80371		40 mm



The indications in the table apply to static read/write operations.

7 Electrical connection



The device must be connected by a qualified electrician.

Device of protection class III (PC III).

The electrical supply must only be made via PELV/SELV circuits.

- ▶ Disconnect power before connecting the device.

7.1 Wiring

- ▶ Connect the device to an IO-Link master using the M12 connector.

- ▷ Voltage is supplied via the IO-Link master.

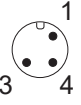
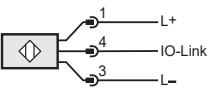
Pin assignment	Wiring
	



Information on available sockets see: www.ifm.com.

8 Operating and display elements

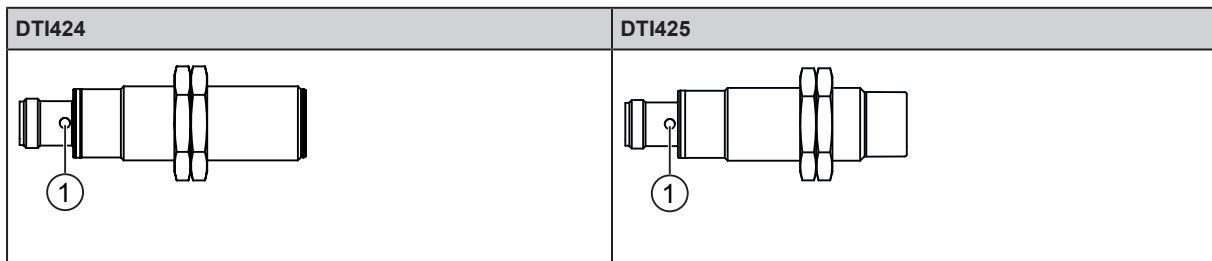

1 LED green: operating voltage

LED yellow: ID tag

LED	State	Description
green	on	operating voltage OK
	off	operating voltage missing
	flashing slowly	deactivated
yellow	on (permanently)	ID tag detected
	on (pulse)	ID tag read/written successfully
	flashing quickly	error when reading/writing on ID tag
	off	<ul style="list-style-type: none"> • no ID tag in the field • faulty ID tag in the field • invalid ID tag in the field
green and yellow	flashing alternately	error in communication or device fault

9 Parameter setting

The parameters of the device are set using a software via IO-Link (for example ifm moneo configure SA).



More information can be found in the IODD of the unit: www.ifm.com

9.1 Parameter

9.1.1 Data block size

The memory area of an ID tag is organised in data blocks. The parameter specifies the size of a data block. The set value must correspond with the value of the ID tag indicated in the data sheet.

The following values are permissible:

4,8,16 and 32 bytes per block.

The data block size is only required for the internal data processing in the device. The user can access the process data images byte by byte on the memory area of the ID tag.

9.1.2 Data alignment

The parameter sets the order of the data in a data block of the ID tag.

Example

For an ID tag with block size 4 bytes the data can be ordered as in the tables:

Data block 0				Data block 1	
Byte 3	Byte 2	Byte 1	Byte 0	Byte 3	...

Tab. 1: Normal order

Data block 0				Data block 1	
Byte 0	Byte 1	Byte 2	Byte 3	Byte 0	...

Tab. 2: Reversed order

9.1.3 Data hold time

The data hold time indicates the time during which the data of the process data input image can be held constant. Depending on the operating mode, this concerns

- the UID,
- the "Tag present" bit,
- the data in Auto read and Auto write mode.

The parameter "Data hold time" does not influence data transfer in the operating modes "Read data" and "Write data".

Example

When the data hold time is set to 500 ms, the UID and the "Tag present" bit are transferred for min. 500 ms via IO-Link.

This also applies if the ID tag is no longer within the range of the device.

9.1.4 Address for automatic read/write

The parameter "Address for automatic read/write" sets the start address of the memory area that is accessed in the operating modes "Auto read" and "Auto write".

The address is provided in bytes.

In the operating modes "Auto read" and "Auto write" the device reads and writes a specified number of data of the ID tag automatically.

The addressed memory area must be within the available memory area of the ID tag:

$$\begin{aligned} &\text{Address for automatic reading and writing} + \\ &\text{Data length for automatic reading and writing} \leq \\ &\text{Number of available bytes on the ID tag} \end{aligned}$$

The number of available bytes is indicated in the data sheet of the ID tag.

9.1.5 Data length for automatic read/write

The parameter "Data length for automatic read/write" sets the length of the memory area that is read and written.

The length is indicated in bytes. The minimum length is 1 byte and the maximum length is 29 bytes.

In the operating modes "Auto read" and "Auto write" the device reads and writes a specified number of data of the ID tag automatically.

The addressed memory area must be within the available memory area of the ID tag:

$$\begin{aligned} &\text{Address for automatic reading and writing} + \\ &\text{Data length for automatic reading and writing} \leq \\ &\text{Number of available bytes on the ID tag} \end{aligned}$$

The number of available bytes is indicated in the data sheet of the ID tag.

9.2 Status bits

Process data input								
Bit	7	6	5	4	3	2	1	0
Name					Antenna de-activated	Tag present	Cmd End	Cmd Start Acknowledge

Process data output								
Bit	7	6	5	4	3	2	1	0
Name					Cmd Antenna deactivate			Cmd Start

Status bit	Value	Description
Antenna deactivated	0	Antenna activated, device ready to receive
	1	Antenna deactivated, device not ready to receive
Tag present	0	No ID tag in the range of the device
	1	ID tag detected
Cmd End	0	Read or write operation not yet started or active

Status bit	Value	Description
Cmd End	1	Read or write operation terminated
Cmd Start Acknowledge	0	Start of a read or write operation not acknowledged
	1	Start of a read or write operation acknowledged
Cmd Antenna deactivate	0	Activate antenna
	1	Deactivate antenna
Cmd Start	0	Reset trigger for read or write operation
	1	Set trigger for read or write operation



The following status bits cannot be used in the "Read UID" operating mode:

- ▶ Cmd Start
- ▶ Cmd Start Acknowledge
- ▶ Cmd End

10 Operation

The device supports several operation modes selected with the command value in the process data output image:

Operating mode	Command value	Description
Read UID	0x00	Operating mode Read UID (→ □ 17)
Auto read data	0x01	Operating mode Auto read data (→ □ 18)
Auto write data	0x02	Operating mode Auto write data (→ □ 19)
Read data	0x03	Operating mode Read data (→ □ 20)
Write data	0x04	Operating mode Write data (→ □ 24)

For all operating modes, the same status bits and error values in the process images apply.

10.1 Deactivate internal antenna

The internal antenna of the unit can be deactivated at any time. With antenna deactivated

- the device can still be accessed via IO-Link,
- no high-frequency magnetic field is generated by the unit,
- the unit does not recognise ID tags.

Interference between units mounted next to each other is reduced by deactivating the antenna.

Deactivate the internal antenna:

- ▶ Set the "Cmd Antenna deactivate" bit in the process data output.



The status of the internal antenna is queried via the bit "Antenna deactivated" in the process data input image.

10.2 Operating mode Read UID

In the operating mode "Read UID" the UID of an ID tag is read. Then the UID is available in the process data input. If no ID tag is in the range of the device, the 8 bytes of the UID get the value "0x00".

As soon as an ID tag is detected by the device, the UID is transferred. The transfer is continued for the min. length of the data hold time. If a new ID tag appears in the detection range during the data hold time, the UID of the new ID tag is transferred.



The default operating mode after the unit is started is "Read UID".

Byte	Process data output	Process data input
0	Command value = 0x00	Command value = 0x00
1	Status	Status
2	ignored	UID 0
3	ignored	UID 1
4	ignored	UID 2
5	ignored	UID 3
6	ignored	UID 4
7	ignored	UID 5

Byte	Process data output	Process data input
8	ignored	UID 6
9	ignored	UID 7
10	ignored	0x00
11	ignored	0x00
12	ignored	0x00
13	ignored	0x00
14	ignored	0x00
15	ignored	0x00
16	ignored	0x00
17	ignored	0x00
18	ignored	0x00
19	ignored	0x00
20	ignored	0x00
21	ignored	0x00
22	ignored	0x00
23	ignored	0x00
24	ignored	0x00
25	ignored	0x00
26	ignored	0x00
27	ignored	0x00
28	ignored	0x00
29	ignored	0x00
30	ignored	0x00
31	ignored	Error value

10.3 Operating mode Auto read data

In the operating mode "Auto read data" the bytes 0 to 28 represent the data in the memory area of the **ID tag**. The memory area is set by the parameters "Address for Auto Read/Write" and "Data Length for Auto-Read/Write".

For memory areas with a data length of < 29 bytes the data remaining in the process image is filled with the value 0x00.

The data in the process image is updated as soon as an ID tag enters the detection range. The data in the process image is valid as soon as the status bit "Cmd End" is set.

If the ID tag leaves the detection range, the data is held in the process image according to the data hold time. If the data hold time is exceeded and there is no ID tag in the detection range, the data is filled with the value 0x00.

If the ID tag remains in the detection range, the data can be read with the status bit "Cmd Start". If reading was unsuccessful, the error value is shown in the process image.



The smaller the "Length for Auto Read/Write" is set, the less time is needed for reading. That means that the dwell time of the ID tag in the detection range can be shorter.

Byte	Process data output	Process data input
0	Command value = 0x01	Command value = 0x01
1	Status	Status

Byte	Process data output	Process data input
2	ignored	Data 0
3	ignored	Data 1
4	ignored	Data 2
5	ignored	Data 3
6	ignored	Data 4
7	ignored	Data 5
8	ignored	Data 6
9	ignored	Data 7
10	ignored	Data 8
11	ignored	Data 9
12	ignored	Data 10
13	ignored	Data 11
14	ignored	Data 12
15	ignored	Data 13
16	ignored	Data 14
17	ignored	Data 15
18	ignored	Data 16
19	ignored	Data 17
20	ignored	Data 18
21	ignored	Data 19
22	ignored	Data 20
23	ignored	Data 21
24	ignored	Data 22
25	ignored	Data 23
26	ignored	Data 24
27	ignored	Data 25
28	ignored	Data 26
29	ignored	Data 27
30	ignored	Data 28
31	ignored	Error value

10.4 Operating mode Auto write data

In the operating mode "Auto-write data" the data to be written is defined by the process data output image. The data is set with the parameters "Address for Auto Read/Write" and "Data Length for Auto Read/Write".

The data is written with the address and length to an **ID tag** as soon as the ID tag enters the detection range.

Max. 29 bytes become defined in the process data output image (bytes 0 to 28). For memory areas with a data length of < 29 bytes the remaining data is ignored and not written to the ID tag.

If writing was successful, the written data is copied to the process data input image and the status bit "Cmd End" is set.

If the ID tag leaves the detection range, the data is held in the process image according to the data hold time. If the data hold time is exceeded and there is no ID tag in the detection range, the data is filled with the value 0x00.

If the ID tag remains in the detection range, the data can be written with the status bit "Cmd Start". If writing was unsuccessful, the error value is shown in the process image.



The smaller the "Data Length Auto Read/Write" is set, the less time is needed for writing. That means that the dwell time of the ID tag in the detection range can be shorter.

Byte	Process data output	Process data input
0	Command value = 0x02	Command value = 0x02
1	Status	Status
2	Data 0	Data 0
3	Data 1	Data 1
4	Data 2	Data 2
5	Data 3	Data 3
6	Data 4	Data 4
7	Data 5	Data 5
8	Data 6	Data 6
9	Data 7	Data 7
10	Data 8	Data 8
11	Data 9	Data 9
12	Data 10	Data 10
13	Data 11	Data 11
14	Data 12	Data 12
15	Data 13	Data 13
16	Data 14	Data 14
17	Data 15	Data 15
18	Data 16	Data 16
19	Data 17	Data 17
20	Data 18	Data 18
21	Data 19	Data 19
22	Data 20	Data 20
23	Data 21	Data 21
24	Data 22	Data 22
25	Data 23	Data 23
26	Data 24	Data 24
27	Data 25	Data 25
28	Data 26	Data 26
29	Data 27	Data 27
30	Data 28	Data 28
31	ignored	Error value

10.5 Operating mode Read data

In the operating mode "Read data" more than 29 bytes can be read with a read operation. The data is sequentially transferred from the device to the controller.

Transfer data from the device to the controller:

- ▶ Use the control to set the following values in the process data output: the command value "0x03", the address (16 bits) and the data length (16 bits).
- ▶ With the control, start the read operation with the status bit "Cmd Start".
- ▷ The device acknowledges the start of the read operation by setting the status bit "Cmd Start Acknowledge" in the process data input.
- ▷ The device transfers the data in the process data input (data 0 to 27) and increases the block counter by 1 as soon as the first data of the ID tag is available. The block counter is reset to "0" when the value exceeds "255".
- ▶ With the control, acknowledge the receipt of the data by increasing the block counter in the process data output by "1".
- ▶ The last two steps are repeated until all data has been transferred.
- ▷ The device sets the status bit "Cmd End" with the last transfer.

The read operation is terminated.



If reading was unsuccessful, the device sets the error value and the status bit "Cmd End" in the process image. The data transmission is interrupted.

Byte	Process data output	Process data input
0	Command value = 0x03	Command value = 0x03
1	Status	Status
2	ignored	Data 0
3	ignored	Data 1
4	Address (high byte)	Data 2
5	Address (low byte)	Data 3
6	Length (high byte)	Data 4
7	Length (low byte)	Data 5
8	ignored	Data 6
9	ignored	Data 7
10	ignored	Data 8
11	ignored	Data 9
12	ignored	Data 10
13	ignored	Data 11
14	ignored	Data 12
15	ignored	Data 13
16	ignored	Data 14
17	ignored	Data 15
18	ignored	Data 16
19	ignored	Data 17
20	ignored	Data 18
21	ignored	Data 19
22	ignored	Data 20
23	ignored	Data 21
24	ignored	Data 22
25	ignored	Data 23
26	ignored	Data 24
27	ignored	Data 25

Byte	Process data output	Process data input
28	ignored	Data 26
29	ignored	Data 27
30	Block counter	Block counter
31	ignored	Error value

10.5.1 Example successful reading of data

The example shows that reading of the data was successful.

	Command value	Address	Length	Data 0 to 27	Block counter	Status bit "Cmd Start"
Preset command	0x00	0x0000	0x0000	0x00	0x00	0
Controller sets command (read 35 bytes from address 0x12)	0x03	0x0012	0x0023	0x00	0x00	1
Device acknowledges command	0x03	0x0012	0x0023	0x00	0x00	1
Device sets first byte of the data	0x03	0x0012	0x0023	0x00	0x00	1
Controller acknowledges receipt of the data	0x03	0x0012	0x0023	0x00	0x01	1
Device sets more data and terminates reading	0x03	0x0012	0x0023	0x00	0x01	1
Controller acknowledges receipt of the data	0x03	0x0012	0x0023	0x00	0x02	1
Controller withdraws command value	0x00	0x0000	0x0000	0x00	0x00	0
Device carries out preset command	0x00	0x0000	0x0000	0x00	0x00	0

Tab. 3: Process data output

	Command value	Data 0 to 27	Block counter	Error value	Status bit "Cmd End"	Status bit "Cmd Start"
Preset command	0x00	UID	0x00	0x00	0	0
Controller sets command (read 35 bytes from address 0x12)	0x03	UID	0x00	0x00	0	0
Device acknowledges command	0x03	0x00	0x00	0x00	0	1
Device sets first byte of the data	0x03	Data	0x01	0x00	0	1

	Command value	Data 0 to 27	Block counter	Error value	Status bit "Cmd End"	Status bit "Cmd Start"
Controller acknowledges receipt of the data	0x03	Data	0x01	0x00	0	1
Device sets more data and terminates reading	0x03	Data	0x02	0x00	1	1
Controller acknowledges receipt of the data	0x03	Data	0x02	0x00	1	1
Controller withdraws command value	0x03	Data	0x02	0x00	1	1
Device carries out preset command	0x00	UID	0x00	0x00	0	0

Tab. 4: Process data input

10.5.2 Example unsuccessful reading of data

Example shows that reading of the data was unsuccessful.

	Command value	Address	Length	Data 0 to 27	Block counter	Status bit "Cmd Start"
Preset command	0x00	0x0000	0x0000	0x00	0x00	0
Controller sets command (read 35 bytes from address 0x12)	0x03	0x0012	0x0023	0x00	0x00	1
Device acknowledges command	0x03	0x0012	0x0023	0x00	0x00	1
Device sets first byte of the data	0x03	0x0012	0x0023	0x00	0x00	1
Controller acknowledges receipt of the data	0x03	0x0012	0x0023	0x00	0x01	1
Unit sets error value	0x03	0x0012	0x0023	0x00	0x01	1
(ID tag not available)	0x00	0x0000	0x0000	0x00	0x00	0
Controller withdraws command value	0x00	0x0000	0x0000	0x00	0x00	0

Tab. 5: Process data output

	Command value	Data 0 to 27	Block counter	Error value	Status bit "Cmd End"	Status bit "Cmd Start"
Preset command	0x00	UID	0x00	0x00	0	0

	Command value	Data 0 to 27	Block counter	Error value	Status bit "Cmd End"	Status bit "Cmd Start"
Controller sets command (read 35 bytes from address 0x12)	0x03	UID	0x00	0x00	0	0
Device acknowledges command	0x03	0x00	0x00	0x00	0	1
Device sets first byte of the data	0x03	Data	0x00	0x00	0	1
Controller acknowledges receipt of the data	0x03	Data	0x01	0x00	0	1
Unit sets error value	0x03	Data	0x01	0x11	1	1
(ID tag not available)	0x03	0x00	0x01	0x11	1	1
Controller withdraws command value	0x00	UID	0x00	0x00	0	0

Tab. 6: Process data input

10.6 Operating mode Write data

In the operating mode "Write data" more than 29 bytes can be written with one write operation. The data is sequentially transferred from the controller to the device.

Transferring data from the controller to the device:

- ▶ Use the control to set the following values in the process data output: the command value "0x04", the address (16 bits) and the data length (16 bits).
- ▶ With the control, start the write operation with the status bit "Cmd Start".
- ▷ The device acknowledges the start of the write operation by setting the status bit "Cmd Start Acknowledge" in the process data input.
- ▶ With the control, fill the data in the process data output (data 0 to 27) and increase the block counter by "1". The block counter is reset to "0" when the value exceeds "255".
- ▷ The device acknowledges receipt of the data by increasing the block counter in the process data output by "1".
- ▶ The last two steps are repeated until all data has been transferred.
- ▷ The device sets the status bit "Cmd End" with the last transfer to the ID tag.

The write operation is terminated.



If writing was unsuccessful, the device sets the error value and the status bit "Cmd End" in the process image. The data transmission is interrupted.

Byte	Process data output when starting the write operation	Process data output during data transfer	Process data input
0	Command value=0x04	Command value=0x04	Command value=0x04
1	Status	Status	Status
2	ignored	Data 0	0x00
3	ignored	Data 1	0x00

Byte	Process data output when starting the write operation	Process data output during data transfer	Process data input
4	Address (high byte)	Data 2	0x00
5	Address (low byte)	Data 3	0x00
6	Length (high byte)	Data 4	0x00
7	Length (low byte)	Data 5	0x00
8	ignored	Data 6	0x00
9	ignored	Data 7	0x00
10	ignored	Data 8	0x00
11	ignored	Data 9	0x00
12	ignored	Data 10	0x00
13	ignored	Data 11	0x00
14	ignored	Data 12	0x00
15	ignored	Data 13	0x00
16	ignored	Data 14	0x00
17	ignored	Data 15	0x00
18	ignored	Data 16	0x00
19	ignored	Data 17	0x00
20	ignored	Data 18	0x00
21	ignored	Data 19	0x00
22	ignored	Data 20	0x00
23	ignored	Data 21	0x00
24	ignored	Data 22	0x00
25	ignored	Data 23	0x00
26	ignored	Data 24	0x00
27	ignored	Data 25	0x00
28	ignored	Data 26	0x00
29	ignored	Data 27	0x00
30	0x00	Block counter	Block counter
31	ignored	ignored	Error value

10.6.1 Example successful writing of data

The example shows successful writing of data.

	Command value	Address	Length	Data 0 to 27	Block counter	Status bit "Cmd Start"
Preset command	0x00	0x0000	0x0000	0x00	0x00	0
Controller sets command (write 40 bytes to address 0x10)	0x04	0x0010	0x0028	0x00	0x00	1
Device acknowledges command	0x04	0x0010	0x0028	0x00	0x00	1
Controller transfers the first data	0x04	Data for ID tag			0x01	1

	Command value	Address	Length	Data 0 to 27	Block counter	Status bit "Cmd Start"
Device acknowledges data	0x04	Data for ID tag			0x01	1
Controller transfers more data	0x04	Data for ID tag			0x02	1
Device acknowledges data and terminates writing	0x04	Data for ID tag			0x02	1
Controller withdraws command value	0x00	0x0000	0x0000	0x00	0x00	0
Device carries out preset command	0x00	0x0000	0x0000	0x00	0x00	0

Tab. 7: Process data output

	Command value	Data 0 to 27	Block counter	Error value	Status bit "Cmd End"	Status bit "Cmd Start"
Preset command	0x00	UID	0x00	0x00	0	0
Controller sets command (write 40 bytes to address 0x10)	0x04	UID	0x00	0x00	0	0
Device acknowledges command	0x04	0x00	0x00	0x00	0	1
Controller transfers the first data	0x04	0x00	0x00	0x00	0	1
Device acknowledges data	0x04	0x00	0x01	0x00	0	1
Controller transfers more data	0x04	0x00	0x01	0x00	0	1
Device acknowledges data and terminates writing	0x04	0x00	0x02	0x00	1	1
Controller withdraws command value	0x04	0x00	0x02	0x00	1	1
Device carries out preset command	0x00	UID	0x00	0x00	0	0

Tab. 8: Process data input

10.6.2 Example unsuccessful writing of data

Example shows that writing of the data was unsuccessful.

	Command value	Address	Length	Data 0 to 27	Block counter	Status bit "Cmd Start"
Preset command	0x00	0x0000	0x0000	0x00	0x00	0
Controller sets command (write 40 bytes to address 0x10)	0x04	0x0010	0x0028	0x00	0x00	1
Device acknowledges command	0x04	0x0010	0x0028	0x00	0x00	1
Controller transfers the first data	0x04	Data for ID tag			0x01	1
Device acknowledges data	0x04	Data for ID tag			0x01	1
Controller transfers more data	0x04	Data for ID tag			0x02	1
Device sets error value (ID tag not available)	0x04	Data for ID tag			0x02	1
Controller withdraws command value	0x00	0x0000	0x0000	0x00	0x00	0
Device carries out preset command	0x00	0x0000	0x0000	0x00	0x00	0

Tab. 9: Process data output

	Command value	Data 0 to 27	Block counter	Error value	Status bit "Cmd End"	Status bit "Cmd Start"
Preset command	0x00	UID	0x00	0x00	0	0
Controller sets command (write 40 bytes to address 0x10)	0x04	UID	0x00	0x00	0	0
Device acknowledges command	0x04	0x00	0x00	0x00	0	1
Controller transfers the first data	0x04	0x00	0x00	0x00	0	1
Device acknowledges data	0x04	0x00	0x01	0x00	0	1
Controller transfers more data	0x04	0x00	0x01	0x00	0	1
Device acknowledges data and terminates writing	0x04	0x00	0x01	0x11	1	1
Controller withdraws command value	0x04	0x00	0x01	0x11	1	1

	Command value	Data 0 to 27	Block counter	Error value	Status bit "Cmd End"	Status bit "Cmd Start"
Device carries out preset command	0x00	UID	0x00	0x00	0	0

Tab. 10: Process data input

10.7 Error values in the process data input

Value	Name	Description
0x00	RFID_NOERROR	No error, read or write operation successful.
0x01	RFID_UNKNOWN_COMMAND	Unknown command value
0x11	COMMAND_NO_RESPONSE	<ul style="list-style-type: none"> ID tag does not respond. ID tag outside the range. ID tag does not support the operation or wrong parameter (e.g. the data block is too big).
0x12	COMMAND_RX_ERROR	Error during reception of the data of the ID tag.
0x21	TAG_COMMAND_NOT_SPECIFIED	Command is not supported by the ID tag.
0x22	TAG_COMMAND_SYNTAX	Parameter of the command wrong.
0x23	TAG_OPTION_NOT_SUPPORTED	ID tag does not support option of the command.
0x2F	TAG_OTHER	ID tag indicates other error during execution of the command.
0x30	TAG_BLOCK_NOT_USABLE	The data block of the ID tag cannot be used (e.g. the data block does not exist).
0x31	TAG_BLOCK_ALREADY_BLOCKED	The data block was already locked.
0x32	TAG_BLOCK_NOT_UPDATEABLE	The data block is locked and cannot be overwritten.
0x33	TAG_BLOCK_WRITE_VERIFY	The data block was not correctly written (e.g. the memory area is defective).
0x34	TAG_BLOCK_LOCK_VERIFY	The data block cannot be locked (e.g. the memory area is defective).

11 Maintenance, repair and disposal

The unit is maintenance-free.

- ▶ Contact ifm in case of malfunction.
- ▶ Do not open the housing as the unit does not contain any components which can be maintained by the user. The unit must only be repaired by the manufacturer.
- ▶ Clean the device using a dry cloth.
- ▶ Dispose of the unit in accordance with the national environmental regulations.

12 Approvals/standards

For approvals and standards, the following information is available:

- Test standards and regulations: documentation.ifm.com
- EU declaration of conformity and approvals: documentation.ifm.com
- Notes relevant for approval: package inserts of the device

Glossary

ID tag

An ID tag is used to identify objects. A read/write device is used to read the ID tag via a high-frequency radio signal. An ID tag consists of an antenna, an analogue circuit for receiving and transmitting (transceiver), a digital circuit and a non-volatile memory.

IODD

Digital description of the device. The IODD is required for device parameter setting via IO-Link.

IO-Link

IO-Link is a standardised IO technology (IEC 61131-9) for communicating with sensors and actuators. Point-to-point communication is based on 3-wire sensor and actuator connection. IO-Link is not a fieldbus, but the further development of the previous connection technology.

UID

Unique Identification Number; unique identification number of a device.