



CE

Operating instructions  
Electronic manometer

**PG28xx**

UK

11433185 / 00 03 / 2019

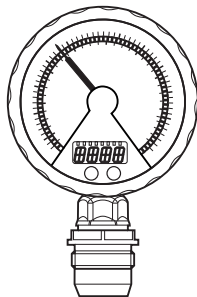

# Contents

1 Preliminary note.....	3
1.1 Symbols used.....	3
2 Safety instructions .....	3
3 Functions and features .....	4
3.1 Applications .....	4
4 Function.....	5
4.1 Processing of the measured signals.....	5
4.2 Pressure monitoring / switching function .....	6
4.3 Pressure monitoring / analogue function .....	6
4.4 Customer-specific calibration .....	8
5 Installation.....	9
6 Electrical connection.....	10
7 Operating and display elements .....	11
8 Menu.....	12
8.1 Menu structure: main menu.....	12
8.2 Explanation of the main menu .....	13
8.3 Menu structure: level 2 (extended functions).....	14
8.4 Explanation of the menu level 2 .....	15
9 Parameter setting .....	16
9.1 General parameter setting.....	16
9.2 Configuration of the digital display (optional).....	18
9.3 Set output signals .....	19
9.3.1 Set output functions.....	19
9.3.2 Set switching limits .....	19
9.3.3 Scale analogue value for OUT2 .....	19
9.4 User settings (optional).....	20
9.4.1 Carry out zero point calibration .....	20
9.4.2 Set delay time for OUT1 .....	20
9.4.3 Set switching logic for OUT1 .....	20
9.4.4 Set damping for the switching signal .....	20
9.4.5 Set damping for the analogue signal .....	21
9.4.6 Calibrate curve of measured values.....	21

9.5 Service functions .....	22
9.5.1 Read min/max values for system pressure .....	22
9.5.2 Reset all parameters to factory setting .....	22
10 Operation.....	22
10.1 Read set parameters .....	22
10.2 Error indications.....	22
10.3 Setting ranges .....	23
10.4 Further technical data.....	23
11 Factory setting .....	24

## 1 Preliminary note

### 1.1 Symbols used

- ▶ Instruction
- > Reaction, result
- [...] Designation of pushbuttons, buttons or indications
- Cross-reference

 Important note  
Non-compliance can result in malfunctions or interference.

 Information  
Supplementary note.

## 2 Safety instructions

- Read this document before setting up the product and keep it during the entire service life.
- The product must be suitable for the corresponding applications and environmental conditions without any restrictions.
- Only use the product for its intended purpose (→ Functions and features).
- Only use the product for permissible media (→ Technical data).
- If the operating instructions or the technical data are not adhered to, personal injury and/or damage to property may occur.
- The manufacturer assumes no liability or warranty for any consequences caused by tampering with the product or incorrect use by the operator.

- Installation, electrical connection, set-up, operation and maintenance of the unit must be carried out by qualified personnel authorised by the machine operator.
- Protect units and cables against damage.



The unit must only be installed in a process connection for G1 sealing cones (e.g. ifm welding adapter, order no. E30013).

If the unit is installed in a 1" thread without sealing cone, this will lead to seal failure. Please use the PG27xx series in these applications.

For the scope of validity cULus:

The device shall be supplied from an isolating transformer having a secondary Listed fuse rated either

- max 5 amps for voltages 0~20 Vrms (0~28.3 Vp) or
- 100/Vp for voltages of 20~30 Vrms (28.3~42.4 Vp).

The Sensor shall be connected only by using any R/C (CYJV2) cord, having suitable ratings.

### 3 Functions and features

The unit monitors the system pressure in a plant.

#### 3.1 Applications

Type of pressure: relative pressure

Order no.	Measuring range (in brackets: extended display range)		Permissible overpressure		Bursting pressure	
	bar	PSI	bar	PSI	bar	PSI
PG2893	-1...25 (40)	-14.4...362.7 (580.2)	100	1450	350	5070
PG2894	-1...10 (16)	-14.5...145 (232)	50	725	150	2175
PG2895	-1...4 (6.4)	-14.5...58 (92.8)	30	435	100	1450
PG2896	-0.124...2.5 (4)	-1.8...36.27 (58.02)	20	290	50	725
PG2897	-0.05...1 (1.6)	-0.73...14.5 (23.21)	10	145	30	435
PG2899	-1...1 (1.6)	-14.5...14.5 (23.20)	10	145	30	435
	mbar	inH2O	bar	PSI	bar	PSI
PG2898	-12.4...250 (400)	-5.0...100.4 (160.6)	6	84	30	435
PG2889	-5...100 (160)	-2.0...40.15 (64.25)	4	58	30	435



Avoid static and dynamic overpressure exceeding the given overload pressure by taking appropriate measures.

The indicated bursting pressure must not be exceeded.

Even if the bursting pressure is exceeded only for a short time, the unit may be destroyed. **ATTENTION: risk of injury!**

Use in gases at pressures > 25 bar only after contacting the manufacturer ifm.



The unit can be operated at media temperatures up to 145°C (max. 1h) / 125°C (permanently). Therefore it is suitable for all standard cleaning and sterilisation processes (CIP, SIP).

## 4 Function

### 4.1 Processing of the measured signals

- The unit generates 2 output signals according to the parameter settings.

OUT1	• Switching signal for system pressure limit value.
OUT2	• Analogue signal (4...20 mA, 20...4 mA).

- The unit displays the current system pressure.

Analogue display: circular scale with pointer.
Digital display (alphanumeric display, 4 digits).

- In addition, an LED ring with one of the following display options is available:

Display of set point and reset point.
Trend display (rising pressure / falling pressure).
Lag indicator function for maximum value or minimum value.
Display of pulsating signals and pressure peaks.

## 4.2 Pressure monitoring / switching function

OUT1 changes its switching state if it is above or below the set switching limits (SP1, rP1). The following switching functions can be selected:

- Hysteresis function / normally open: [OU1] = [Hno] (→ fig. 1).
- Hysteresis function / normally closed: [OU1] = [Hnc] (→ fig. 1).

First the set point (SP1) is set, then the reset point (rP1) with the requested difference.

- Window function / normally open: [OU1] = [Fno] (→ fig. 2).
- Window function / normally closed: [OU1] = [Fnc] (→ fig. 2).

The width of the window can be set by means of the difference between SP1 and rP1. SP1 = upper value, rP1 = lower value.

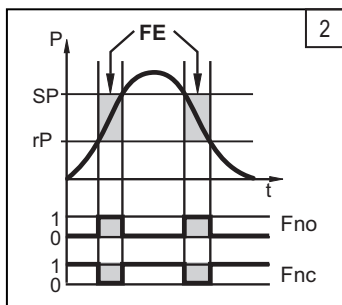
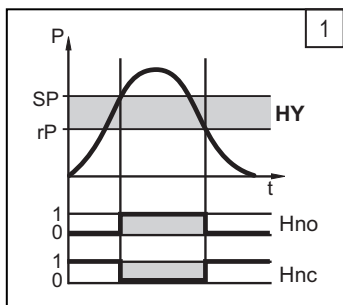

P = system pressure; HY = hysteresis; FE = window

## 4.3 Pressure monitoring / analogue function

The analogue output can be configured: [OU2] defines whether the set measuring range is provided as 4...20 mA ([OU2] = [I]) or as 20...4 mA ([OU2] = [InEG]).

Scaling can be set by means of the teaching process or by entering a value for the ASP and AEP parameters.

- Teaching the analogue start point [tASP] or setting the parameter [ASP] defines at which measured value the analogue signal is 4 mA (20 mA at [InEG]).
- Teaching the analogue end point [tAEP] or setting the parameter [AEP] defines at which measured value the output signal is 20 mA (4 mA at [InEG]).

Minimum distance between [ASP] and [AEP] = 25 % of the final value of the measuring range.

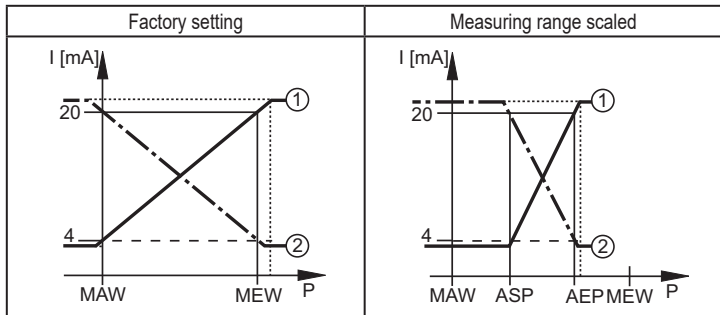

P = system pressure , MAW = initial value / MEW = final value of the measuring range

①: [OU2] = [I]; ②: [OU2] = [InEG]

In the set measuring range the output signal is between 4 and 20 mA ([OU2] = [I]) or between 20 and 4 mA ([OU2] = [InEG]).

It is also indicated:

- System pressure above the measuring range:
  - Output signal 20 to 20.5 mA at [OU2] = [I].
  - Output signal 4 to 3.8 mA at [OU2] = [InEG].
- System pressure below the measuring range:
  - Output signal 4 to 3.8 mA at [OU2] = [I].
  - Output signal 20 to 20.5 mA at [OU2] = [InEG].

## 4.4 Customer-specific calibration

The customer-specific calibration changes the curve of measured values compared to the real measured values (shifting / change of the gradient; ( $\rightarrow$  9.4.6) [CAL]).

- Two calibration points can be defined (CP1, CP2). The two points are independent of each other. They must be within the measuring range and not in the extended display range.
- The zero point calibration [COF] influences the calibration of the curve of measured values. Recommendation: set [COF] to 0 ( $\rightarrow$  9.4.1) [COF]), then calibrate the curve of measured values.

After a change the calibration can be reset to factory setting ( $\rightarrow$  9.5.2) [rES]).

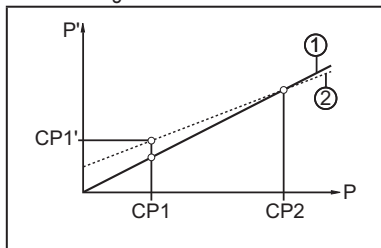

- P = measured pressure;
- P' = modified measured value
- CP1 = calibration point 1;
- CP1' = modified measured value for CP1
- CP2 = calibration point 2;
- 1 = curve of measured values at factory setting
- 2 = curve of measured values after calibration

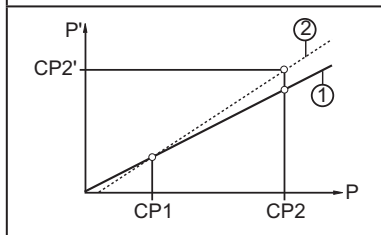

- P = measured pressure;
- P' = modified measured value
- CP1 = calibration point 1;
- CP2 = calibration point 2;
- CP2' = modified measured value for CP2
- 1 = curve of measured values at factory setting
- 2 = curve of measured values after calibration

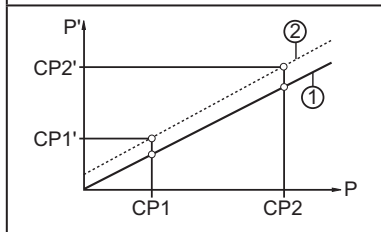

- P = measured pressure;
- P' = modified measured value
- CP1 = calibration point 1;
- CP1' = modified measured value for CP1
- CP2 = calibration point 2;
- CP2' = modified measured value for CP2
- 1 = curve of measured values at factory setting
- 2 = curve of measured values after calibration



## 5 Installation



Before installing and removing the unit: make sure that no pressure is applied to the system. Note: If 0% is displayed and no pointer is visible, this does not mean that no pressure is applied to the system!



The unit must only be installed in a process connection for G1 sealing cones (e.g. ifm welding adapter, order no. E30013).

If the unit is installed in a 1" thread without sealing cone, this will lead to seal failure. Please use the PG27xx series in these applications.

### Installation in a process connection for a G1 sealing cones

- ▶ Slightly grease the thread of the threaded sleeve (B) using a lubricating paste which is suitable and approved for the application.
- ▶ Insert the unit (A) into the process connection (C), push the threaded sleeve towards the internal thread of the process connection and lightly screw it in.
- ▶ Orientate the unit, tighten the threaded sleeve with a spanner and ensure that the unit is correctly oriented while doing so.  
Tightening torque 20 Nm.

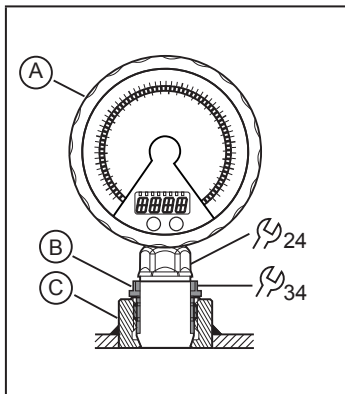

### Use in hygienic areas to EHEDG

- ▶ Make sure that the sensors are integrated into the system in accordance with EHEDG.



After installation the analogue display can be rotated / adapted to the installation position. Use gloves to do so.

## 6 Electrical connection



The unit must be connected by a qualified electrician.

The national and international regulations for the installation of electrical equipment must be adhered to.

Voltage supply according to EN 50178, SELV, PELV.

- ▶ Disconnect power.
- ▶ Connect the unit as follows:

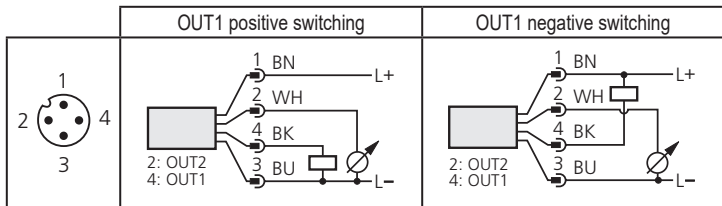

Pin 1	Ub+
Pin 3	Ub-
Pin 4 (OUT1)	• Binary switching output pressure monitoring
Pin 2 (OUT2)	• Analogue output for system pressure

Core colours of ifm sockets:

1 = BN (brown), 2 = WH (white), 3 = BU (blue), 4 = BK (black)

## 7 Operating and display elements

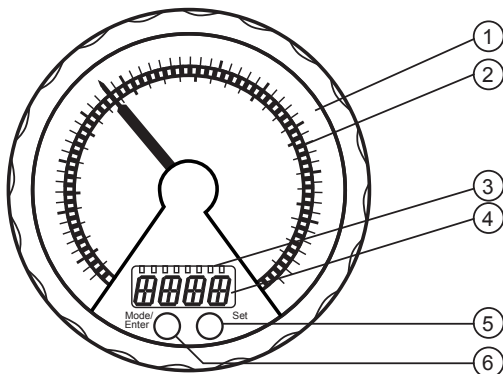

### 1: Analogue display

- Display of the current system pressure in bar and PSI or mbar and inH2O.

### 2: LED ring

According to the setting of parameter [LED] (→ 9.2):

- Display of set point and reset point.
- Lag indicator function for maximum value or minimum value.
- Display of pulsating signals and pressure peaks.
- Trend display: rising pressure or falling pressure.

### 3: Indicator LEDs

- LED 1 = system pressure of the digital display in bar.
- LED 2 = system pressure of the digital display in mbar.
- LED 3 = system pressure of the digital display in PSI.
- LED 4 = system pressure of the digital display in inH2O.
- LED 6 = system pressure in % of the scaling (range ASP to AEP) or COF value in %.
- LEDs 5, 7 = not used.
- LED 8 = switching status OUT1 (lights if output 1 is switched)

### 4: Alphanumeric display, 4 digits

- Display of the current system pressure.
- Display of the parameters and parameter values.

### 5: Touch button Set\*

- Setting of the parameter values (continuously by touching permanently; step by step by touching briefly several times).

## 6: Touch button Mode/Enter\*

- Selection of the parameters and acknowledgement of the parameter values.

\* The two touch buttons are activated simply by touching / deactivated by releasing the touch button.

The touch button must be completely covered to be activated.

Slow covering (e.g. liquid flows over the display) does not activate the touch button.

# 8 Menu

## 8.1 Menu structure: main menu

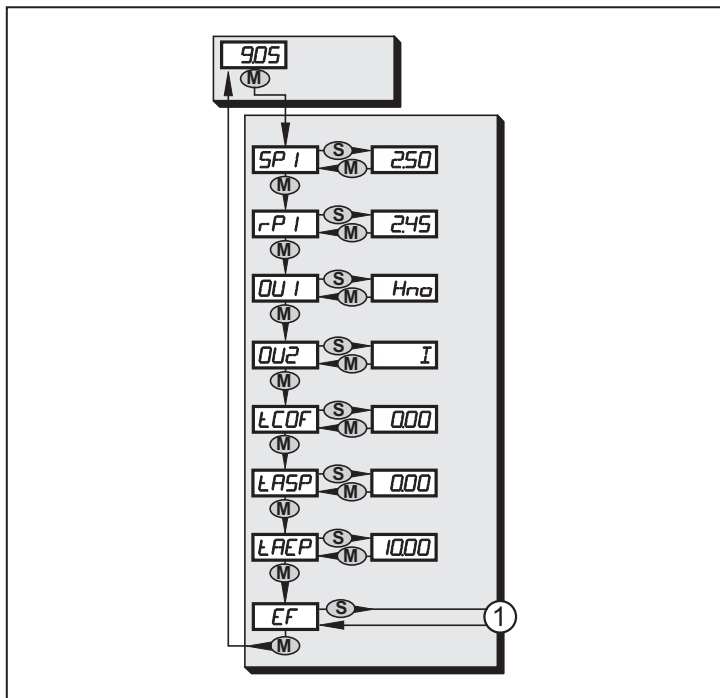

1: Change to menu level 2 (extended functions)

## 8.2 Explanation of the main menu

SP1/rP1	Upper / lower limit value for system pressure at which OUT1 switches.
OU1	Output function for OUT1: <ul style="list-style-type: none"><li>• Switching signal for the pressure limit values: hysteresis function [H ..] or window function [F ..], either normally open [. no] or normally closed [. nc].</li></ul>
OU2	Output function for OUT2: <ul style="list-style-type: none"><li>• Analogue signal for the current system pressure: 4...20 mA [I], 20...4 mA [InEG].</li></ul>
tCOF	Teach zero-point calibration.
tASP	Teach analogue start point for system pressure: set measured value at which 4 mA is provided (20 mA if [OU2] = [InEG]).
tAEP	Teach analogue end point for system pressure: set measured value at which 20 mA is provided (4 mA if [OU2] = [InEG]).
EF	Extended functions / opening of menu level 2.

UK



## 8.4 Explanation of the menu level 2

Uni	Standard unit of measurement for system pressure.
SEld	Display mode: <ul style="list-style-type: none"><li>• Pressure in the unit set in [Uni].</li><li>• Pressure in % of the set scaling of the analogue output.</li></ul>
ASP	Analogue start point for system pressure: measured value at which 4 mA is provided (20 mA if [OU2] = [InEG]).
AEP	Analogue end point for system pressure: measured value at which 20 mA is provided (4 mA if [OU2] = [InEG]).
HI	Maximum value memory for system pressure.
LO	Minimum value memory for system pressure.
COF	Zero-point calibration.
dS1	Switch-on delay for OUT1.
dr1	Switch-off delay for OUT1.
P-n	Switching logic for OUT1: pnp or npn.
dAP	Damping for switching outputs and display.
dAA	Damping for analogue output (OUT2).
diS	Update rate and orientation of the display.
LED	Setting for the LED ring.
CAL	Calibration function (setting the curve of measured values).
CP1	Calibration point 1
CP2	Calibration point 2
rES	Restore factory settings.

UK



## 9 Parameter setting

During parameter setting the unit remains in the operating mode. It continues its monitoring function with the existing parameters until the parameter setting has been completed.

Exceptions: changes to the parameters COF (→ 9.4.1), CP1 and CP2 (→ 9.4.6) take effect immediately

### 9.1 General parameter setting

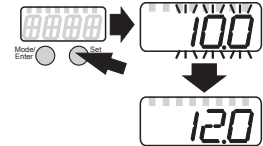
3 steps must be taken for each parameter setting:



1	Select parameter ▶ Touch [Mode/Enter] until the requested parameter is displayed.	
2	Set parameter value ▶ Touch [Set] and keep it touched. > Current setting value of the parameter flashes for 5 s. > After 5 s: setting value is changed: step by step by touching briefly several times or continuously by touching permanently.	
Numerical values are incremented continuously. To reduce the value: let the display move to the maximum setting value. Then the cycle starts again at the minimum setting value.		
3	Acknowledge parameter value ▶ Touch [Mode/Enter] briefly. > The parameter is displayed again. The new setting value is saved.	
Set other parameters ▶ Start again with step 1.		
Finish parameter setting ▶ Touch [Mode/Enter] several times until the current measured value is displayed or wait for 15 s. > The unit returns to the operating mode.		

#### • Timeout:

If no touch button is activated for 15 s during parameter setting, the unit returns to the operating mode with unchanged values.



- Change from menu level 1 to menu level 2:

<ul style="list-style-type: none"> <li>▶ Touch [Mode/Enter] until [EF] is displayed.</li> </ul>	
<ul style="list-style-type: none"> <li>▶ Touch [Set] briefly.</li> <li>&gt; The first parameter of the submenu is displayed (here: [Uni]).</li> </ul> <p>If the menu level 2 is protected by an access code, "Cod1" flashes in the display.</p> <ul style="list-style-type: none"> <li>▶ Touch [Set] and keep it touched until the valid code no. appears.</li> <li>▶ Touch [Mode/Enter] briefly.</li> </ul> <p>On delivery by ifm electronic: no access restriction.</p>	

- Locking / unlocking

The unit can be locked electronically to prevent an unintentional operation.

<ul style="list-style-type: none"> <li>▶ Make sure that the unit is in the normal operating mode.</li> <li>▶ Touch [Set],</li> <li>▶ additionally touch [Mode/Enter] and keep both buttons touched for 10 s.</li> <li>&gt; The LED for the current unit of measurement flashes, the current system pressure continues to be displayed. After 10 s the display goes out for approx. 1 s.</li> <li>▶ Release [Mode/Enter] and [Set] again. Both buttons must be released within 4 s. If this does not happen, the unit remains unlocked.</li> <li>&gt; [Loc] is displayed, the unit is locked. .</li> </ul> <p>During operation the indicator LED for the display unit (→ 7 Operating and display elements) is flashing if you try to open the menu.</p>
<p>For unlocking:</p> <ul style="list-style-type: none"> <li>▶ Make sure that the unit is in the normal operating mode.</li> <li>▶ Touch [Set],</li> <li>▶ additionally touch [Mode/Enter] and keep both buttons touched for 10 s.</li> <li>&gt; The LED for the current unit of measurement flashes, the current system pressure continues to be displayed. After 10 s the display goes out for approx. 1 s.</li> <li>▶ Release [Mode/Enter] and [Set] again. Both buttons must be released within 4 s. If this does not happen, the unit remains locked.</li> <li>&gt; [uLoc] is displayed, the unit is unlocked.</li> </ul>

On delivery: unlocked.

## 9.2 Configuration of the digital display (optional)

<p>▶ Select [Uni] and set the unit of measurement: - [bAr], [mbAr], [PSI], [inHO].</p> <p> The unit of measurement available for selection depends on the device. See table Setting ranges (→ 10.3).</p>	<b>Uni</b>
<p>▶ Select [SELD] and set type of indication: - [P]: system pressure in the unit set in Uni. - [P%]: system pressure in % of the set scaling of the analogue output; the following applies: 0% = ASP value / 100% = AEP value. Note: display "0%" does not mean that no pressure is applied to the system.</p>	<b>SELD</b>
<p>▶ Select [diS] and set the update rate of the display: - [d1]: update of the measured values every 50 ms. - [d2]: update of the measured values every 200 ms. - [d3]: update of the measured values every 600 ms. - [OFF] = The measured value display is deactivated in the Run mode. Touching one of the buttons indicates the current measured value for 15 s. Touching the [Mode/Enter] button again activates the display mode. The indicator LEDs remain active even if the display is deactivated.</p>	<b>d, S</b>
<p>▶ Select [LED] and set the display function for the digital display and LED ring:</p> <ul style="list-style-type: none"> <li>- [SPRP]: One LED on the LED ring indicates the set point and a second LED the reset point.</li> <li>- [HInd]: 2 adjacent LEDs on the LED ring mark the lag indicator for maximum value ([HInd], high indication).</li> <li>- [LInd]: 2 adjacent LEDs on the LED ring mark the lag indicator for minimum value ([LInd], low indication).</li> </ul> <p>To reset:</p> <ul style="list-style-type: none"> <li>▶ Touch [Set] for 1 second.             <ul style="list-style-type: none"> <li>&gt; The two LEDs jump to the current position of the pointer.</li> </ul> </li> <li>- [Ph]: Display of pulsating signals and pressure peaks:             <ul style="list-style-type: none"> <li>- In case of quick pressure changes (quickly pulsating signals) the digital display and LED ring indicate the minimum value and the maximum value.</li> <li>- In case of one-time short pressure peaks the digital display and LED ring show the indication for a longer time.</li> </ul> </li> <li>- [Pdir]: The LED ring indicates the trend of the pressure changes (5 LEDs below the pointer for rising pressure; 5 LEDs above the pointer for falling pressure).</li> </ul> <p>A damping set with dAP or dAA also has an effect on this display.</p>	<b>LED</b>

## 9.3 Set output signals

### 9.3.1 Set output functions

<ul style="list-style-type: none"><li>▶ Select [OU1] and set the switching function:<ul style="list-style-type: none"><li>- [Hno] = hysteresis function/NO.</li><li>- [Hnc] = hysteresis function/NC.</li><li>- [Fno] = window function/NO.</li><li>- [Fnc] = window function/NC.</li></ul></li></ul>	<i>OU 1</i>
<ul style="list-style-type: none"><li>▶ Select [OU2] and set the analogue function:<ul style="list-style-type: none"><li>- [I] = current signal proportional to pressure 4...20 mA.</li><li>- [InEG] = current signal proportional to pressure 20...4 mA.</li></ul></li></ul>	<i>OU2</i>

UK

### 9.3.2 Set switching limits

<ul style="list-style-type: none"><li>▶ Select [SP1] and set the value at which the output switches.</li></ul>	<i>SP 1</i>
<ul style="list-style-type: none"><li>▶ Select [rP1] and set the value at which OUT1 switches off. rP1 is always smaller than SP1. The unit only accepts values which are lower than SP1.</li></ul>	<i>rP 1</i>



### 9.3.3 Scale analogue value for OUT2

<ul style="list-style-type: none"><li>▶ Set the minimum pressure requested in the system.</li><li>▶ Touch [Mode/Enter] until [tASP] appears.</li><li>▶ Touch [Set] and keep it touched.<ul style="list-style-type: none"><li>&gt; Current setting value flashes.</li></ul></li><li>▶ Release [Set] when the display stops flashing.<ul style="list-style-type: none"><li>&gt; New setting value is displayed.</li></ul></li><li>▶ Touch [Mode/Enter] briefly.<ul style="list-style-type: none"><li>&gt; The current system pressure is defined as start value for the analogue signal.</li></ul></li></ul>	<i>tASP</i>
<ul style="list-style-type: none"><li>▶ Set the maximum pressure requested in the system.</li><li>▶ Touch [Mode/Enter] until [tAEP] appears.</li><li>▶ Touch [Set] and keep it touched.<ul style="list-style-type: none"><li>&gt; Current setting value flashes.</li></ul></li><li>▶ Release [Set] when the display stops flashing.<ul style="list-style-type: none"><li>&gt; New setting value is displayed.</li></ul></li><li>▶ Touch [Mode/Enter] briefly.<ul style="list-style-type: none"><li>&gt; The current system pressure is defined as end value for the analogue signal.</li></ul></li></ul>	<i>tAEP</i>
ASP / AEP can only be set automatically within defined limits (→ 10.3 Setting ranges). If automatic setting is carried out at an invalid pressure value, [UL] or [OL] is displayed. After acknowledgement by [Mode/Enter] [Err] flashes, the ASP value / AEP value is not changed.	

<p>As an alternative:</p> <ul style="list-style-type: none"> <li>▶ Select [ASP] and set the measured value at which 4 mA is provided (20 mA at [OU2] = [InEG]).</li> <li>▶ Select [AEP] and set the measured value at which 20 mA is provided (4 mA at [OU2] = [InEG]).</li> </ul> <p>Minimum distance between ASP and AEP = 25 % of the final value of the measuring range (turn-down 1:4).</p>	
--	--

## 9.4 User settings (optional)

### 9.4.1 Carry out zero point calibration

<ul style="list-style-type: none"> <li>▶ Select [COF] and set a value between -5% and 5% of the final value of the measuring range. The internal measured value "0" is shifted by this value.</li> </ul>	
<p>As an alternative: automatic adjustment of the offset in the range 0 bar ± 5 %.</p> <ul style="list-style-type: none"> <li>▶ Make sure that no pressure is applied to the system.</li> <li>▶ Touch [Mode/Enter] until [tCOF] appears.</li> <li>▶ Touch [Set] and keep it touched.</li> <li>&gt; The current offset value (in %) flashes briefly.</li> <li>&gt; The current system pressure is displayed.</li> <li>▶ Release [Set].</li> <li>▶ Touch [Mode/Enter] briefly (= to confirm the new offset value).</li> </ul>	

### 9.4.2 Set delay time for OUT1

<p>[dS1] = switch-on delay / [dr1] = switch-off delay.</p> <ul style="list-style-type: none"> <li>▶ Select [dS1] or [dr1] and set a value between 0.1 and 50 s (at 0.0 the delay time is not active).</li> </ul>	
--	---

### 9.4.3 Set switching logic for OUT1

<ul style="list-style-type: none"> <li>▶ Select [P-n] and set [PnP] or [nPn].</li> </ul>	
--	--

### 9.4.4 Set damping for the switching signal

<ul style="list-style-type: none"> <li>▶ Select [dAP] and set a value between 0.01 and 30 s.</li> </ul> <p>dAP value = response time between pressure change and change of the switching status in seconds.</p> <p>[dAP] influences the switching frequency: <math>f_{\max} = 1 \div 2dAP</math>.</p> <p>[dAP] also has an effect on the display.</p>	
---	---

## 9.4.5 Set damping for the analogue signal

- ▶ Select [dAA] and set a value between 0.01 and 30 s.  
dAA value = response time between pressure change and change of the analogue signal in seconds.

dAA

## 9.4.6 Calibrate curve of measured values

If the unit is to adopt the settings for the calibration points, the following conditions must be adhered to:

- CP1 and CP2 must be within the measuring range (i.e. between ASP and AEP).
- CP1 and CP2 must not be in the extended display range.
- Minimum distance between the calibration points CP1 and CP2 = 5 % of the final value of the measuring range.
- Maximum correction value =  $\pm 2$  % of the final value of the measuring range.

- ▶ Set a defined reference pressure between ASP and AEP in the system.
  - ▶ Select [CAL].
  - ▶ Touch [Set] briefly.
  - > [CP1] is displayed.
  - ▶ Touch [Set] for 5 s.
  - > The pressure measured by the unit is displayed.
  - ▶ Touch [Set] until the set reference pressure is indicated (measured pressure = reference pressure) or the corresponding analogue signal is provided to OUT2.
  - ▶ Touch [Mode/Enter] briefly.
  - > [CP1] is displayed.
  - ▶ Touch [Mode/Enter] briefly.
  - > [CP2] is displayed.
- Continue with a) or b).

CAL  
CP 1

a) Finish calibration:

- ▶ Touch [Mode/Enter] briefly.
  - > [CAL] is displayed.
- b) Change a 2nd point on the curve of measured values:
- ▶ Set a second defined reference pressure in the system.
  - ▶ Touch [Set] for 5 s.
  - > The pressure measured by the unit is displayed.
  - ▶ Touch [Set] until the set reference pressure is indicated (measured pressure = reference pressure) or the corresponding analogue signal is provided to OUT2.
  - ▶ Touch [Mode/Enter] briefly.
  - > [CP2] is displayed.
  - ▶ Touch [Mode/Enter] briefly.
  - > [CAL] is displayed, the process is finished.

CP2

UK

## 9.5 Service functions

### 9.5.1 Read min/max values for system pressure

<ul style="list-style-type: none"><li>▶ Select [HI] or [LO] and touch [Set] briefly. [HI] = maximum value, [LO] = minimum value.</li></ul> Delete memory: <ul style="list-style-type: none"><li>▶ Select [HI] or [LO].</li><li>▶ Touch [Set] and keep it touched until [----] is displayed.</li><li>▶ Touch [Mode/Enter] briefly.</li></ul>	HI LO
---	----------

### 9.5.2 Reset all parameters to factory setting

<ul style="list-style-type: none"><li>▶ Select [rES].</li><li>▶ Touch [Set] and keep it touched until [----] is displayed.</li><li>▶ Touch [Mode/Enter] briefly.</li></ul> It is recommended to take down your own settings in the table before carrying out a reset (→ 11 Factory setting).	rES
--	-----

## 10 Operation

After power on, the unit is in the Run mode (= normal operating mode). It carries out its measurement and evaluation functions and provides output signals according to the set parameters.

Operating indicators (→ 7 Operating and display elements).

Reset the lag indicator (if [LED] = [HInd] or [LInd]):

- ▶ Touch [Set] for 1 second.
- > The two lag indicator LEDs jump to the current position of the pointer.

### 10.1 Read set parameters

- ▶ Touch [Mode/Enter] until the requested parameter is displayed.
- ▶ Touch [Set] briefly.
- > The unit displays the corresponding parameter value for about 15 s. After another 15 s it returns to the Run mode.

### 10.2 Error indications

[OL]	Overload pressure (measuring range exceeded).
[UL]	Underload pressure (below measuring range).
[SC1]	Short circuit in OUT1. The output is switched off as long as the short circuit persists.
[Err]	Flashing: internal error, invalid entry.

The messages SC1 and Err are displayed even if the display is switched off.

## 10.3 Setting ranges

		SP1		rP1		ASP		AEP		ΔP
		min	max	min	max	min	max	min	max	
PG2889	mbar	-4.8	160.0	-5.0	159.8	-5.0	135.0	20.0	160.0	0.1
	inH2O	-1.95	64.25	-2.05	64.15	-2.00	54.20	8.05	64.25	0.05
PG2893	bar	-0.96	40.00	-1.00	39.96	-1.00	33.76	5.24	40.00	0.02
	PSI	-13.8	579.9	-14.4	579.3	-14.4	489.3	75.9	579.9	0.3
PG2894	bar	-0.98	16.00	-1.00	15.98	-1.00	13.50	1.50	16.00	0.01
	PSI	-14.3	232.0	-14.5	231.8	-14.5	195.7	21.8	232.0	0.1
PG2895	bar	-0.990	6.400	-1.000	6.390	-1.000	5.400	0.000	6.400	0.005
	PSI	-14.35	92.80	-14.50	92.70	-14.50	78.30	0.00	92.80	0.05
PG2896	bar	-0.120	4.000	-0.124	3.996	-0.124	3.370	0.500	4.000	0.002
	PSI	-1.74	58.02	-1.80	57.96	-1.80	48.87	7.26	58.02	0.03
PG2897	bar	-0.048	1.600	-0.050	1.598	-0.050	1.350	0.200	1.600	0.001
	PSI	-0.69	23.22	-0.73	23.19	-0.73	19.59	2.91	23.22	0.01
PG2898	mbar	-12.0	400.0	-12.4	399.6	-12.4	337.6	50.0	400.0	0.2
	inH2O	-4.8	160.6	-5.0	160.4	-5.0	135.5	20.1	160.6	0.1
PG2899	bar	-0.998	1.600	-1.000	1.598	-1.000	1.100	-0.500	1.600	0.001
	PSI	-14.45	23.20	-14.50	23.18	-14.50	15.95	-7.25	23.20	0.02

ΔP = step increment

## 10.4 Further technical data



Further technical data and scale drawing at [www.ifm.com](http://www.ifm.com).

## 11 Factory setting

	Factory setting	User setting
SP1	25.0 % VMR*	
rP1	24.9 % VMR*	
OU1	Hno	
OU2	I	
COF / tCOF	0.0	
ASP / tASP	0% VMR*	
AEP / tAEP	100% VMR*	
Uni	bAr / mbAr	
SELd	P	
dS1	0.0	
dr1	0.0	
P-n	pnp	
dAP	0.06	
dAA	0.03	
dis	d2	
LED	SPRP	
CP1	0.00	
CP2	0.00	

\* = the indicated percentage of the final value of the measuring range (VMR) of the corresponding sensor is set (for PG2899 the percentage of the measuring span).



More information at [www.ifm.com](http://www.ifm.com)