



CE

Operating instructions
LED dome light

O2D93x

UK

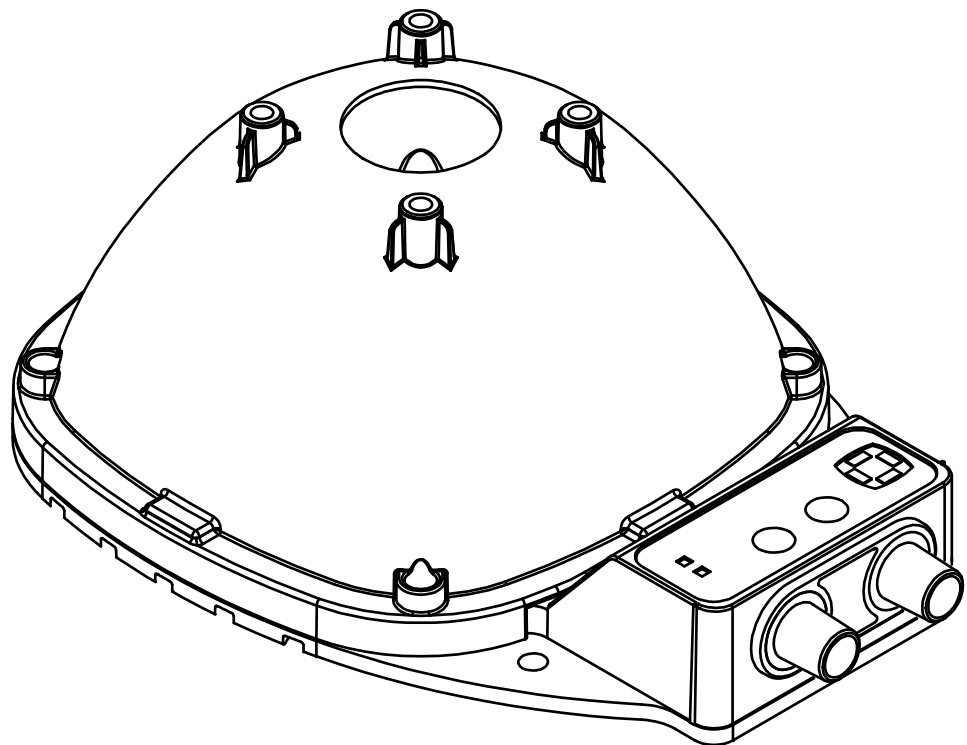

80279745 / 01 08 / 2019



Content

1	Preliminary note	3
1.1	Symbols used	3
1.2	Warnings used	3
1.3	Copyright and trademarks	3
2	Safety instructions	4
3	Functions and features	5
4	Items supplied.	5
5	Installation.	6
5.1	Install device.	6
5.2	Install vision sensor	6
6	Electrical connection.	7
6.1	Wiring	7
6.2	Mode continuous light	8
6.2.1	PNP	8
6.2.2	NPN	8
6.3	Mode pulse operation	8
6.3.1	PNP	8
6.3.2	NPN	8
7	Operating and display elements	9
7.1	Set colours and segments	9
8	Set-up	10
8.1	Mode continuous light	10
8.2	Mode pulse operation.	10
8.2.1	High lighting power	10
8.2.2	Signal delay	11
8.3	Dim lighting power	11
8.4	External control	12
9	Maintenance, repair and disposal.	12

1 Preliminary note

Technical data, approvals, accessories and further information →
www.ifm.com.

1.1 Symbols used

- ▶ Instruction
- > Reaction, result
- [...] Designation of keys, buttons or indications
- Cross-reference
-  Important note
Non-compliance may result in malfunction or interference.
-  Information
Supplementary note.

UK

1.2 Warnings used



CAUTION!

Warning of personal injury.
Slight reversible injuries may result.

ATTENTION!

Warning of damage to property

1.3 Copyright and trademarks

© All rights reserved by ifm electronic gmbh. No part of these instructions may be reproduced and used without the consent of ifm electronic gmbh.

All product names, pictures, companies or other brands used on our pages are the property of the respective rights owners.

2 Safety instructions

- The device described is a subcomponent for integration into a system.
 - The manufacturer is responsible for the safety of the system.
 - The system manufacturer undertakes to perform a risk assessment and to create a documentation in accordance with legal and normative requirements to be provided to the operator and user of the system. This documentation must contain all necessary information and safety instructions for the operator, the user and, if applicable, for any service personnel authorised by the manufacturer of the system.
- Read this document before setting up the product and keep it during the entire service life.
- The product must be suitable for the corresponding applications and environmental conditions without any restrictions.
- Only use the product for its intended purpose (→ Functions and features).
- If the operating instructions or the technical data are not adhered to, personal injury and/or damage to property may occur.
- The manufacturer assumes no liability or warranty for any consequences caused by tampering with the product or incorrect use by the operator.
- Installation, electrical connection, set-up, operation and maintenance of the product must be carried out by qualified personnel authorised by the machine operator.
- Protect units and cables against damage.



CAUTION!

Invisible infrared light

The device emits infrared light of risk group 1 (IEC 62471) invisible to the human eye.

The infrared light can cause damage to the retina.

- ▶ Use the device for its intended purpose.
- ▶ Avoid staring into the infrared beam.

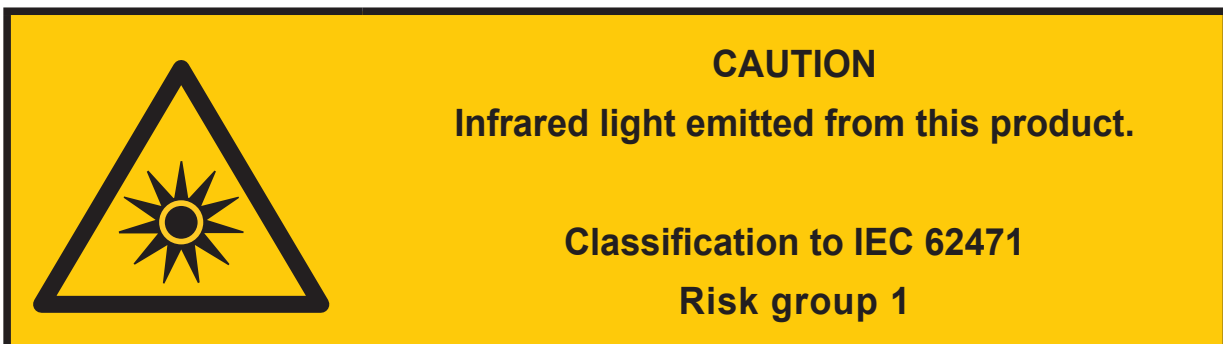

3 Functions and features

The O2D93x illumination unit is an LED dome light for uniform illumination of camera scenes. The LED dome light is split into 4 segments which are arranged as a ring. The segments are programmable regarding light colour and switch-on/switch-off characteristics. Programming is done on the LED dome light via the 2 operating buttons or via external control.

The active mode and the active segments are indicated via LEDs.

The device is designed for indoor use.

Because of the requirements for electromagnetic interference emissions, the device is intended for use in industrial environments. The device is not suitable for use in domestic areas.

UK



The device may only be used under the operating conditions specified in the data sheet.

4 Items supplied

- O2D93x illumination unit
- Operating instructions
- ▶ In the event of incomplete or damaged items supplied please contact ifm electronic.



The device is supplied without mounting and connection accessories.

5 Installation

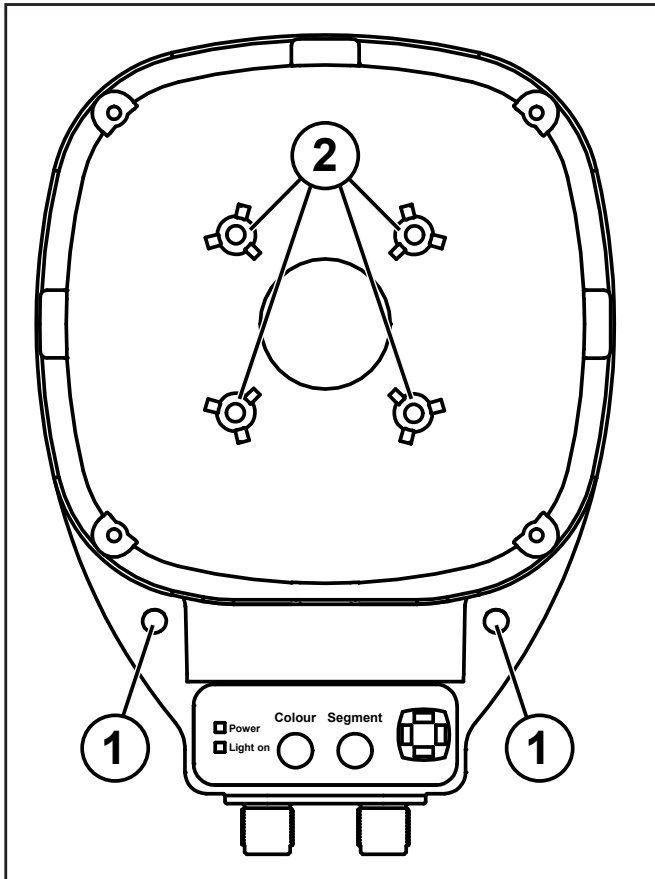

- ①: Mounting holes
- ②: Fixtures for accessory

Fig. 1: Installation

5.1 Install device

- ▶ Install the device via the mounting holes with 2x M5 screws.
 - ▶  For an additional locking of the screws seal them with a screw retaining compound.
- ▶ Tighten the screws with a tightening torque of 0.5 to 1.5 Nm.
- ▶ Use strain reliefs for cables connected to the device.

5.2 Install vision sensor

- ▶ Mount the accessory E2D117 via the fixtures with 4x M3 screws.
- ▶ Tighten the screws with a tightening torque of 0.5 to 1.0 Nm.
- ▶ Mount the vision sensor to the accessory E2D117.
- ▶ Use strain reliefs for cables connected to the vision sensor.

6 Electrical connection

Observe the following instructions before electrical installation.

ATTENTION!

The device must be connected by a qualified electrician. Observe the electrical data in the data sheet.

Device of protection class III (PC III).

The electrical supply must only be made via PELV circuits.

For cable lengths > 30 m use an additional protection against surge voltages to IEC 61000-4-5.

Disconnect power before connecting the device.

UK

6.1 Wiring

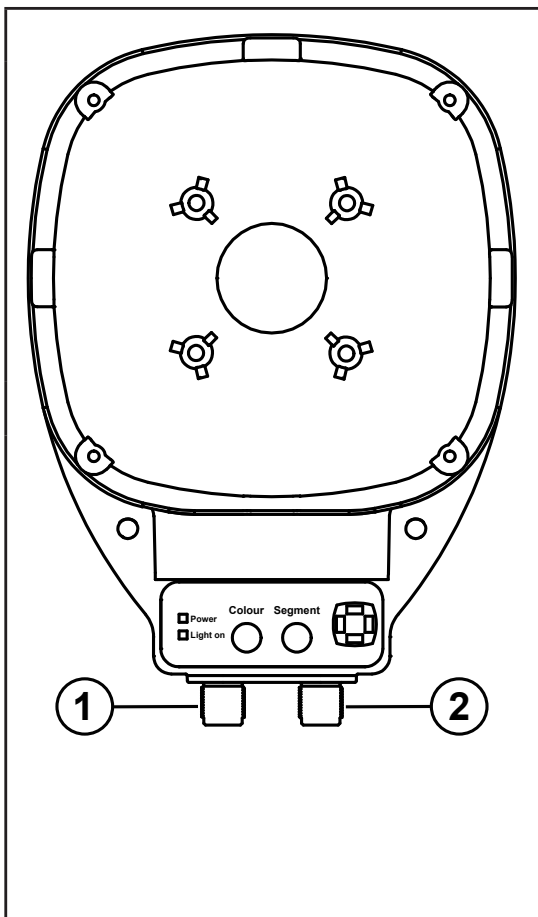

①: Power supply: 5-pole M12 connector

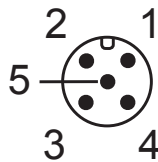

Pin	Connection
1	L+
2	trigger input NPN
3	GND
4	trigger input PNP
5	dimmer 0-10 V

②: External control: 8-pole M12 connector

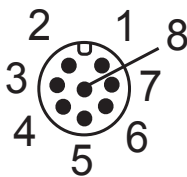

Pin	Connection
1	activate high lighting power
2	activate colour 2
3	GND
4	activate segment 1
5	activate segment 2
6	activate segment 3
7	activate segment 4
8	deactivate buttons

6.2 Mode continuous light

6.2.1 PNP

5-pole M12 connector

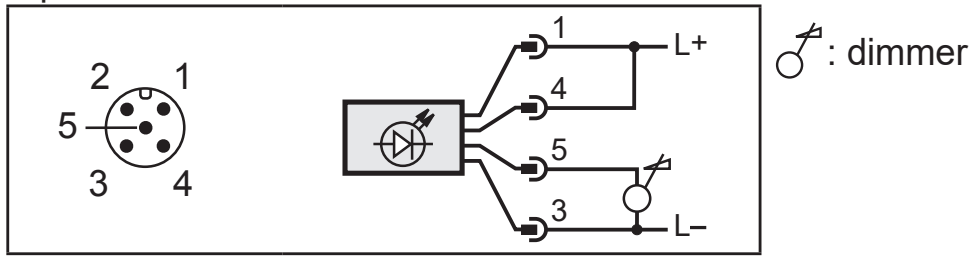

6.2.2 NPN

5-pole M12 connector

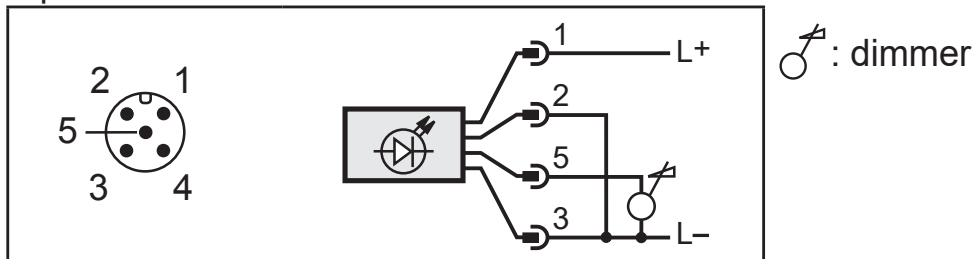

6.3 Mode pulse operation



The EMC noise immunity of the unit can be increased:

- ▶ In the "mode pulse operation PNP" connect pin 2 to L+.
- ▶ In the "mode pulse operation NPN" connect pin 4 to L-.

As a result of the connection the antenna characteristics of the cables are reduced.

6.3.1 PNP

5-pole M12 connector

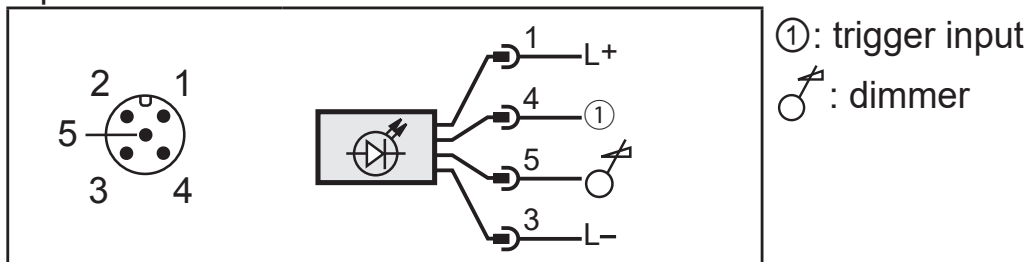

6.3.2 NPN

5-pole M12 connector

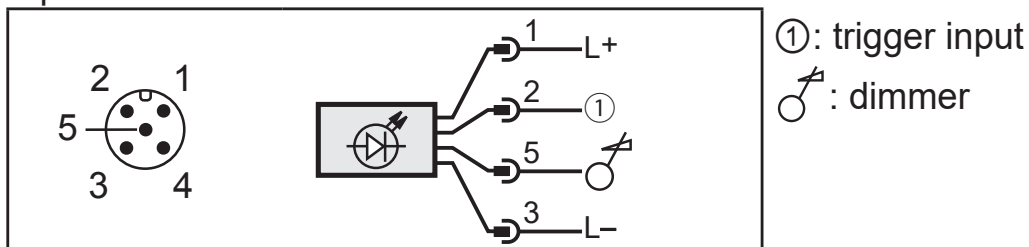

7 Operating and display elements

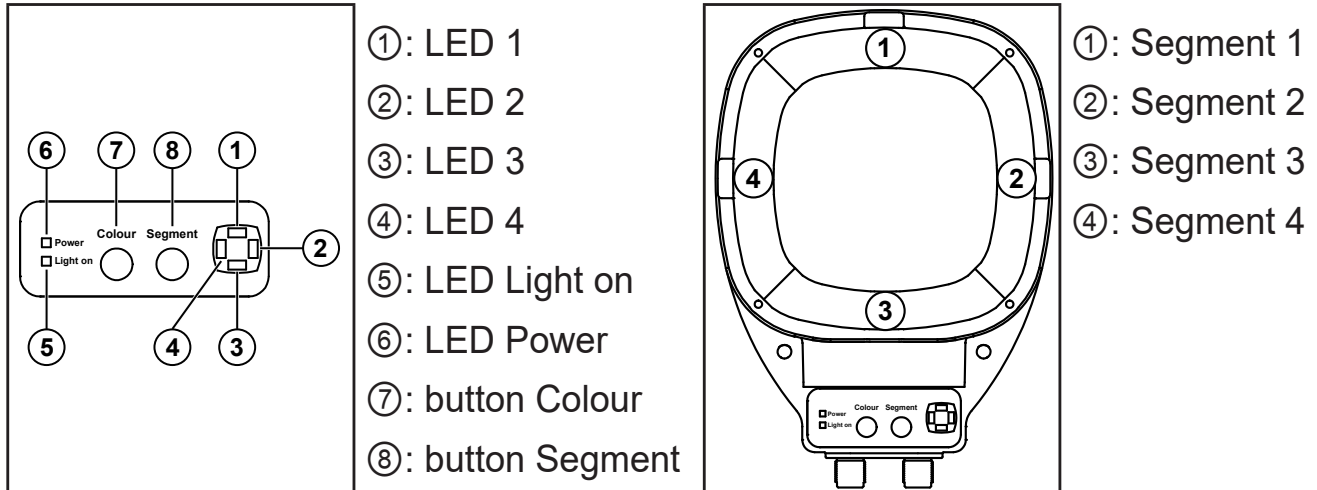

UK

The **LEDs "1" to "4"** indicate what segments will be activated in case of a trigger (→ 7.1 Set colours and segments).

Example: If LEDs 2 and 4 are on, segments 2 and 4 will be activated in case of a trigger.

The **LED "Light on"** is on if a segment is active.

The **LED "Power"** is on if power is supplied.

The **button [Colour]** sets the colour of the segments.

The **button [Segment]** sets the active segments.

7.1 Set colours and segments

- ▶ Press the buttons [Colour] and [Segment] at the same time for 3-4 s.
- > The LEDs "1-4" flash. The button lock is deactivated.
- ▶ Select the colours with the button [Colour]:

Device	Colour 1	Colour 2
O2D930	white	infrared
O2D931	red	cyan
O2D932	white	infrared
O2D933	red	cyan

- ▶ Select the following combinations with the button [Segment]:
 - Segments 2 and 4 active
 - Segments 1 and 3 active
 - Segments 1 to 4 active
- ▶ Press the buttons [Colour] and [Segment] at the same time for 3-4 s.
- > The LEDs "1-4" flash. The button lock is activated. The settings are saved.

8 Set-up

After power on the device is put into operation.

8.1 Mode continuous light

In the mode "continuous light" the device is continuously on. This mode is available after power on (→ 6.2 Mode continuous light).

8.2 Mode pulse operation

In the mode "pulse operation" the device flashes with the frequency of the signal at the trigger input (→ 6.3 Mode pulse operation).

The voltage at the trigger input must have the following characteristics:

Circuit	Voltage	Function
PNP	0-4 V	switch off lighting
PNP	5-24 V	switch on lighting
NPN	2.2-24 V	switch off lighting
NPN	0-2 V	switch on lighting

The frequency at the trigger input must have the following characteristics:

D_{\max}	t_{\min}	t_{\max}	f_{\max}
100 %	5 μ s	continuous operation	50 kHz

8.2.1 High lighting power

In the pulse operation mode the lighting power can be increased. The high lighting power is activated via the external control (→ 8.4 External control).

The frequency at the trigger input must have the following characteristics:

D_{\max}	t_{\min}	t_{\max}	f_{\max}
10 %	5 μ s	2 ms	310 Hz

ATTENTION!

With an active high lighting power the maximum possible frequency is reduced.

A frequency higher than f_{\max} can damage the device.

► f_{\max} = remain continuously below 310 Hz with an active high lighting power.



With $t_{\max} = 2$ ms the illumination is switched on for maximum 2 ms.

If the duty cycle $D_{\max} = 10$ % is exceeded, an internal protection circuit is activated.



With an active high lighting power the response of the illumination is delayed by 10 μ s during switch-on and switch-off.

8.2.2 Signal delay

Changing the colours and segments leads to a signal delay. The signal delay concerns the mode pulse operation with PNP circuit.

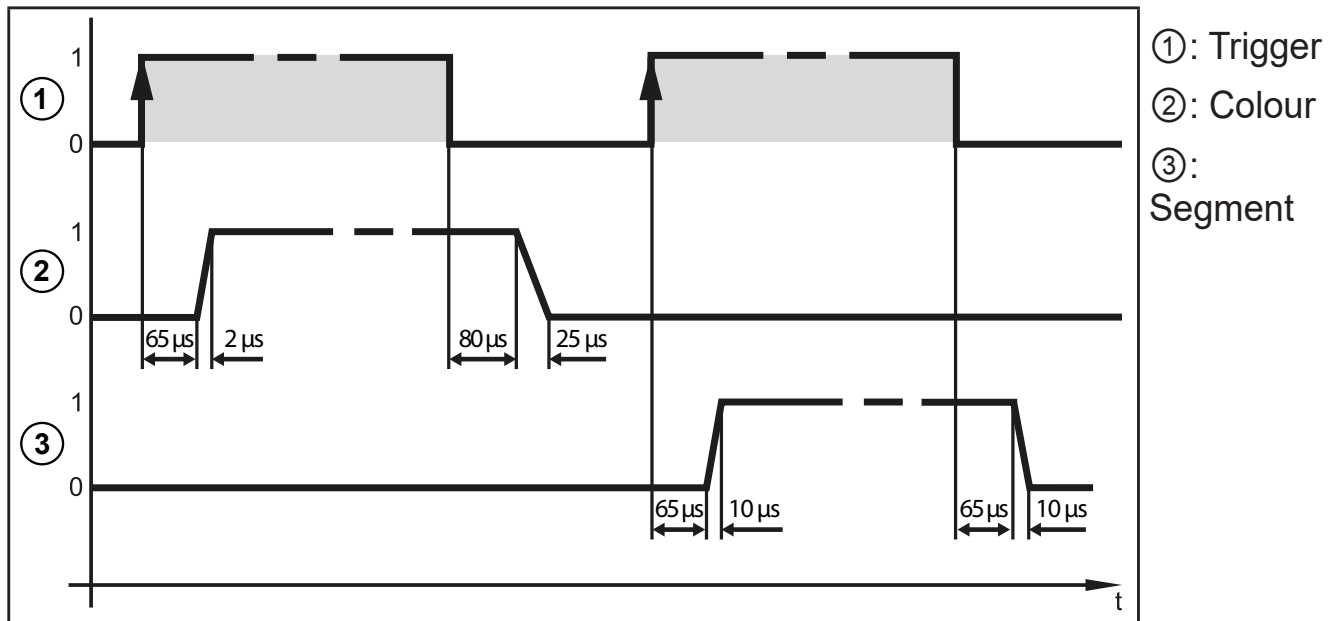

UK

8.3 Dim lighting power

Lighting power can be dimmed in the modes continuous light and pulse operation. For dimming connect a voltage of 0-10 V to pin 5.

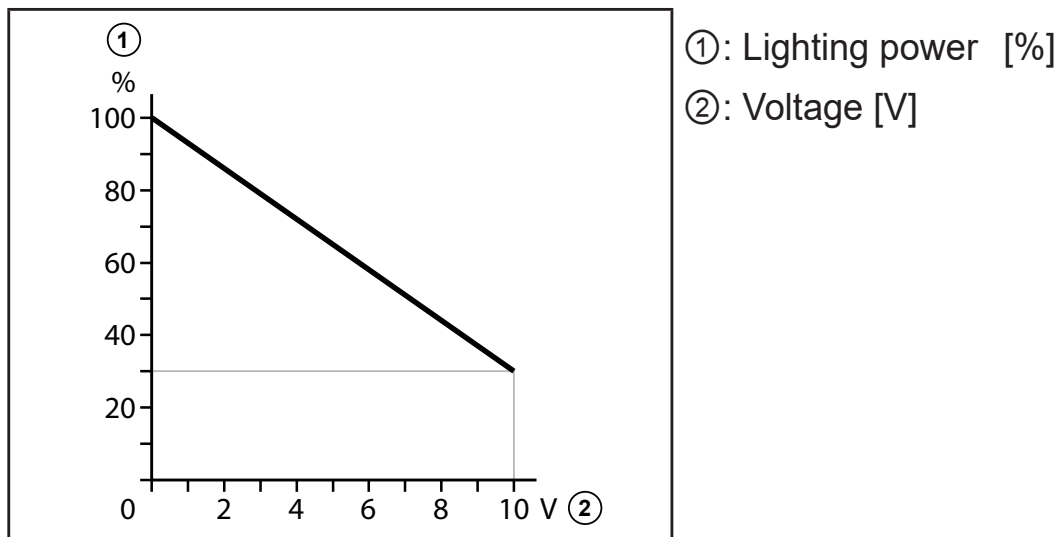

The device lights with 100 % at 0 V at pin 5.

The device lights with 30 % at 10 V at pin 5.

8.4 External control

The device can be controlled externally by connecting the respective pin of the 8-pole M12 connector to a 24 V voltage (→ 6.1 Wiring).

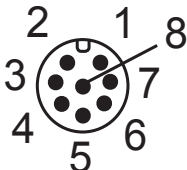

Pin	Connection
1	activate high lighting power
2	activate colour 2
3	GND
4	activate segment 1
5	activate segment 2
6	activate segment 3
7	activate segment 4
8	deactivate buttons

 The following colours are available:

Device	Colour 1	Colour 2
O2D930	white	infrared
O2D931	red	cyan
O2D932	white	infrared
O2D933	red	cyan

9 Maintenance, repair and disposal

The device does not contain any components which can be maintained.

- ▶ Do not open the device
- > The device must only be repaired by the manufacturer.
- ▶ Dispose of the device in accordance with the national environmental regulations.

UK