

Operating instructions
Infrared temperature sensor

TW20xx

TW21xx

UK

80270318 / 00 09 / 2021

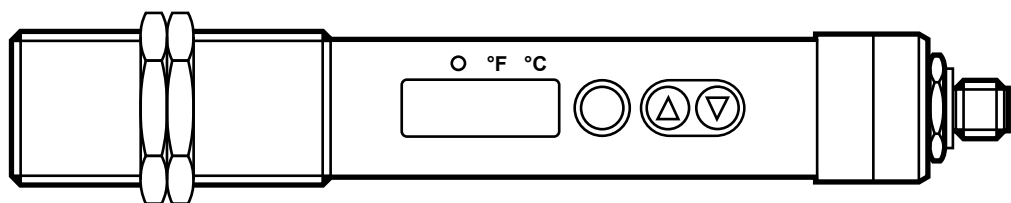

Contents

1	Preliminary note.....	4
1.1	Key to the symbols	4
2	Safety instructions	4
3	Functions and features	4
4	Function.....	5
4.1	Process measured signals	5
4.2	Emissivity of the objects to be measured	5
4.3	Switching function.....	6
4.4	Analogue function	7
4.5	Delay time for the switching output OUT1	8
4.6	Simulation function	9
4.7	Test function.....	9
4.8	Damping function.....	10
4.9	Peak-hold function.....	10
4.10	IO-Link	10
5	Installation.....	11
6	Electrical connection.....	15
6.1	Screening and grounding	16
7	Operating and display elements	16
8	Menu.....	17
8.1	Menu structure.....	17
8.2	Explanation main menu	17
8.3	Explanation extended functions (EF).....	18
8.4	Submenu simulation (SIM)	18
9	Set-up	19
10	Parameter setting	19
10.1	Parameter setting in general	20
10.1.1	Switching between the menu levels	21
10.1.2	Locking / unlocking	21
10.1.3	Timeout.....	21
10.2	Settings for temperature monitoring	22
10.2.1	Setting the degree of emissivity.....	22

10.2.2	Emissivity for TW2000 / TW2003 / TW2100	22
10.2.3	Emissivities for TW2001, TW2101, TW2011, TW2002.....	23
10.2.4	Settings for limit value monitoring with OUT1.....	24
10.2.5	Set the analogue signal for OUT2	24
10.3	User settings (optional).....	24
10.3.1	Set the standard unit of measurement for temperature.....	24
10.3.2	Set delay time for OUT1	24
10.3.3	Set the measured value damping.....	24
10.3.4	Set the peak-hold function.....	25
10.3.5	Setting the simulation function.....	25
10.4	Service functions	25
10.4.1	Reset all parameters to factory setting.....	25
11	Operation	25
11.1	Changing the display unit in the Run mode	25
11.2	Read the set parameters	25
12	Technical data and scale drawing.....	26
13	Troubleshooting	26
14	Maintenance, repair and disposal.....	26
15	Factory setting	27

1 Preliminary note

Technical data, approvals, accessories and further information at www.ifm.com.

1.1 Key to the symbols

▶ Instructions

> Reaction, result

[...] Designation of keys, buttons or indications

→ Cross-reference



Important note

Non-compliance may result in malfunction or interference.



Information

Supplementary note.

2 Safety instructions

- Read this document before setting up the product and keep it during the entire service life.
- The product must be suitable for the corresponding applications and environmental conditions without any restrictions.
- Only use the product for its intended purpose (→ Functions and features).
- If the operating instructions or the technical data are not adhered to, personal injury and/or damage to property may occur.
- The manufacturer assumes no liability or warranty for any consequences caused by tampering with the product or incorrect use by the operator.
- Installation, electrical connection, set-up, operation and maintenance of the unit must be carried out by qualified personnel authorised by the machine operator.
- Protect units and cables against damage.

3 Functions and features

The unit monitors the temperature of particularly hot objects or those with difficult access.

It detects the infrared radiation of objects without contact and converts it into an electrical signal and an analogue output signal (4...20 mA).

4 Function

4.1 Process measured signals

- The unit features an IO-Link interface
- The unit displays the measured temperature.
- It generates two output signals according to the parameter setting:

OUT1: switching output / IO-Link Parameter setting
(→ 10.2.4)
- switching signal: limit values for temperature

OUT2: analogue output Parameter setting
(→ 10.2.5)
- analogue signal for temperature

UK

4.2 Emissivity of the objects to be measured

The infrared temperature sensor reacts to the heat or infrared radiation emitted from the object. This depends on the material and the surface. To get exact measurement results, the emissivity of the object to be measured has to be set on the unit (→ 10.2.1 Setting the degree of emissivity).

The emissivity of an ideal heat radiator (black body) is 100%. The emissivity for real bodies is below 100 %. The emissivities indicated in the tables (→ 10.2.2 and → 10.2.3) are approximate values. To determine the temperature precisely a reference value measurement should be made.



The reference value for TW2000 / TW2003 / TW2100 up to a temperature of 250 °C can be measured using the enclosed label



To compensate environmental influences it may be useful to set a higher emissivity. Therefore a setting up to 110 % is possible.



An incorrectly set emissivity leads to faults during temperature measurement.

4.3 Switching function

OUT1 changes its switching state if it is above or below the set switching limits (SP1, rP1).

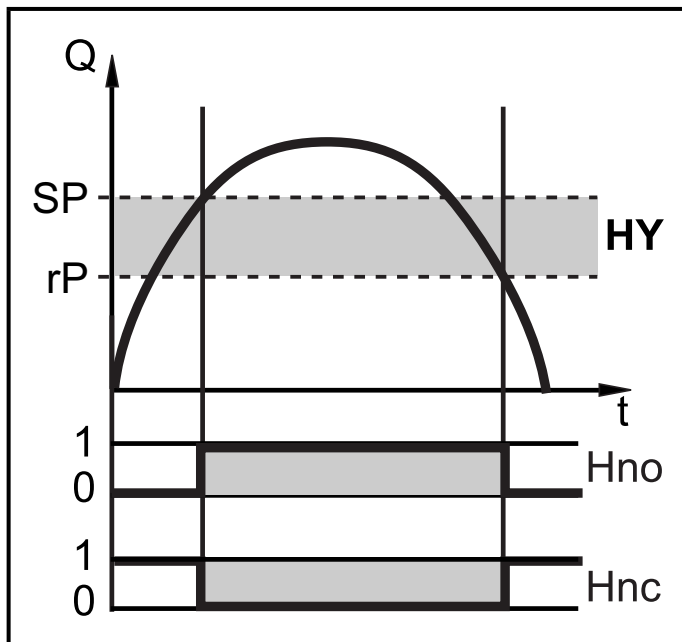

NO: [ou1] = [Hno]

NC: [ou1] = [Hnc]

First the set point (SP1) is set, then the reset point (rP1) with the requested difference.



When SP1 is adjusted, rP1 is changed automatically; the difference remains the same.

Exception: SP1 is reduced to such an extent that if the distance is kept constant, rP1 would fall below the measuring range. In such a case rP1 is kept on the initial value of the measuring range.

4.4 Analogue function

The unit converts the measured signal into a temperature-proportional analogue signal ranging from 4...20 mA.

The measuring range is scalable:

- [ASP2] determines at which measured value the output signal is 4 mA.
- [AEP2] determines at which measured value the output signal is 20mA.

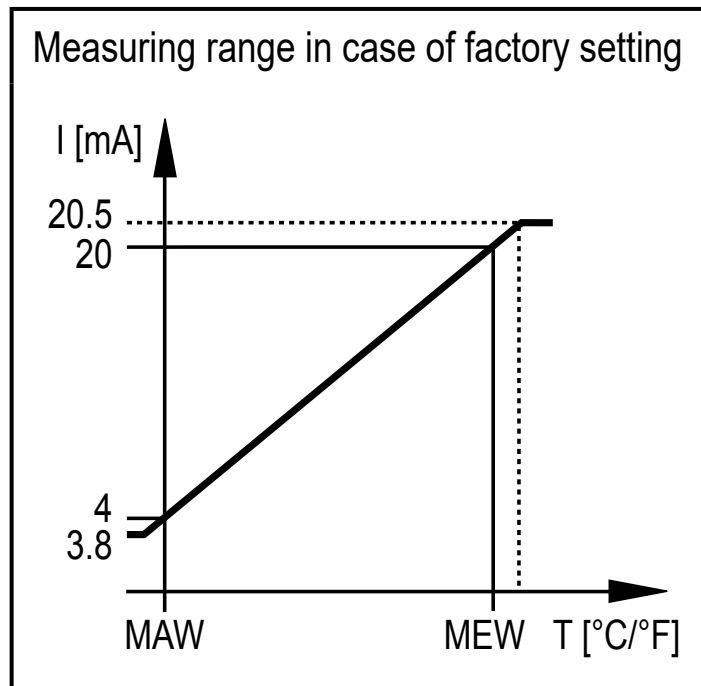

MAW = Initial value of the measuring range
MEW = Final value of the measuring range

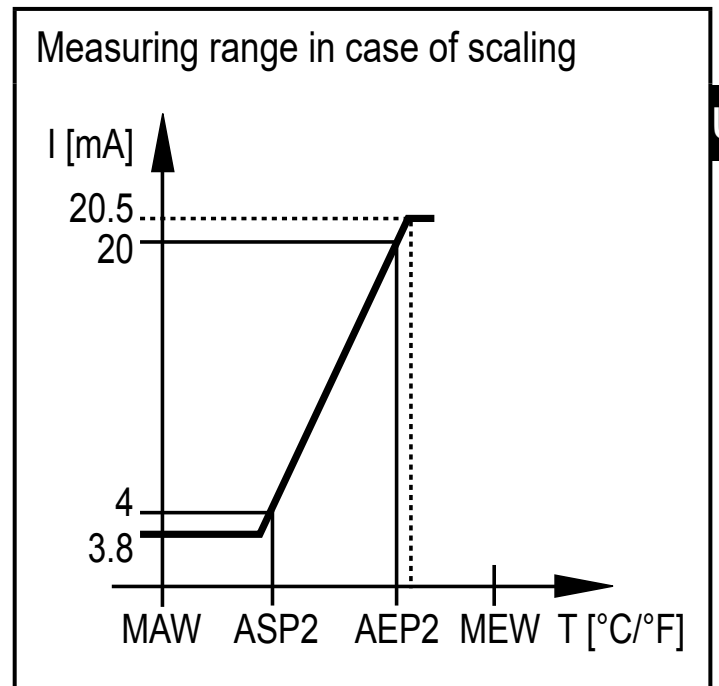

ASP2 = Analogue start point
AEP2 = Analogue end point

UK

4.5 Delay time for the switching output OUT1

When a delay time is set (\rightarrow 10.3.2), OUT1 does not change its switching state right away when the set switching limits (SP1, rP1) are exceeded or not reached but only after the delay time (power-on delay time dS1, power-off delay time dr1) has elapsed. If the switching condition is no longer met after the delay has elapsed, the switching state of the output does not change.

Switching function on OUT1 with and without delay time:

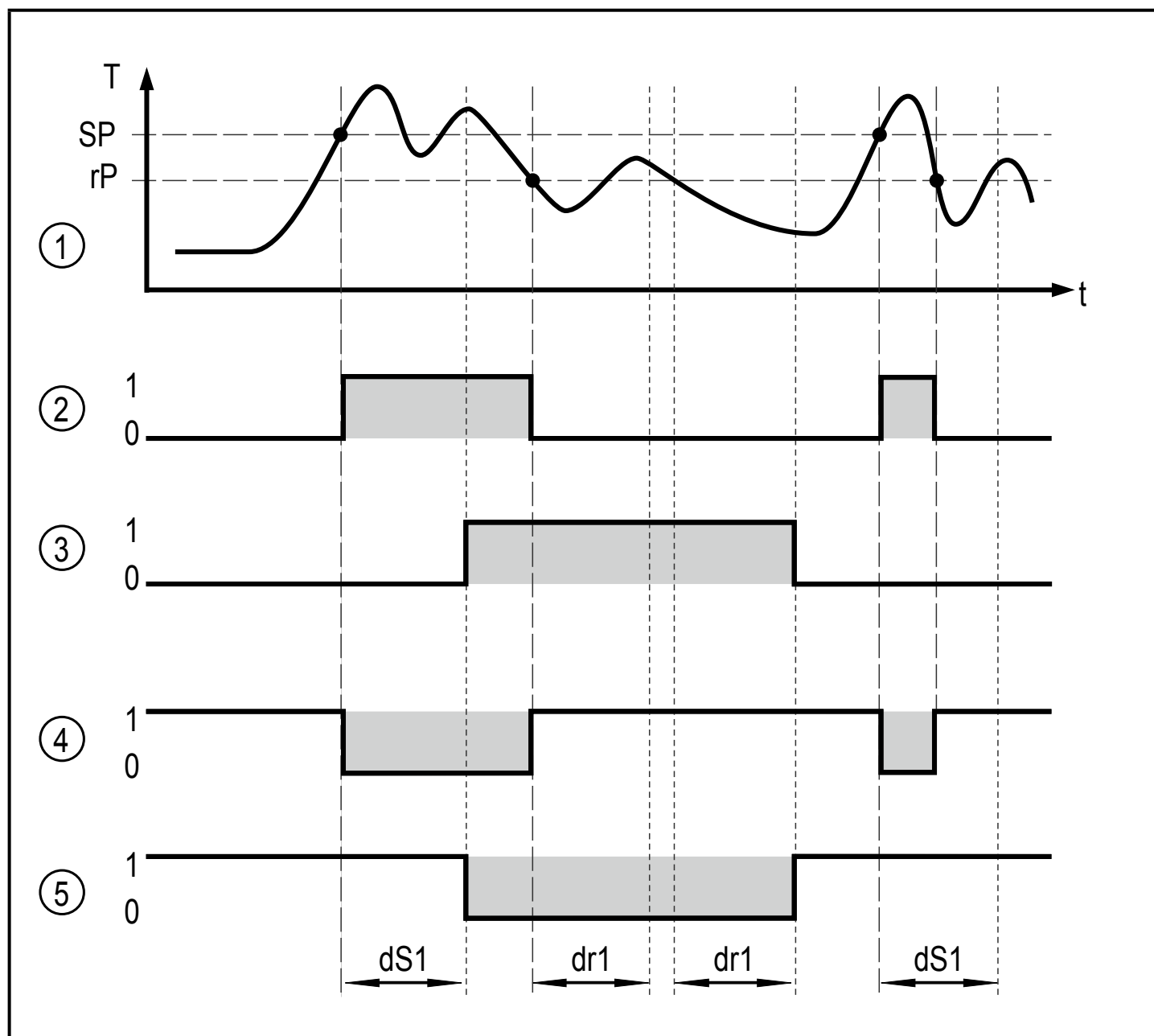

T = temperature

SP = set point

rP = reset point

t = time

dS1 = switch-on delay time

dr1 = switch-off delay time

- (1) Temperature curve of the medium
- (2) Hno (hysteresis function / normally open)
- (3) Hno with switch-on and switch-off delay
- (4) Hnc (hysteresis function, normally closed)
- (5) Hnc with power-on and power-off delay

4.6 Simulation function

The simulation function is helpful when setting up the installation.

Via the SIM menu (→ 10.3.5), it is possible to activate a simulation of any measured temperature within the measuring range. The simulation influences the display and the outputs. After an adjustable period of time, the simulation function stops automatically. To indicate that the simulation mode is activated, the display alternates between the simulated measured value and "SIM".

UK

4.7 Test function

The infrared temperature sensor has an internal test function to check the complete signal processing, the switching output and the analogue output.

The test function is activated by a static signal on pin 5 or via IO-Link. The test function simulates a radiation detector signal which generates an output current of 20.5 mA and triggers the switching function when the sensor operates correctly unless the switching output has already switched depending on the configuration. [OL] is displayed.

The unit remains in the test mode as long as the static signal is on pin 5. If the test function is started via IO-Link, the duration is 10 s. After that, the unit automatically returns to the RUN mode.

To trigger the test function a static signal (10...34 V to IEC 61131-2) > 300 ms has to be applied via pin 5. The test function is deactivated via a static "low" signal > 300 ms on pin 5.



If the test function is not used:

- ▶ Put the test input (pin 5) to minus supply.
- ▶ Alternatively use a 4-pole socket in which pin 5 is not connected.

4.8 Damping function

If there are brief fluctuations in the temperature of the object to be measured, the damping function stabilises the measured signal. The higher the selected time constant dAP (→ 10.3.3 Set the measured value damping) the lower the influence of the interfering temperature fluctuations on the measured value.

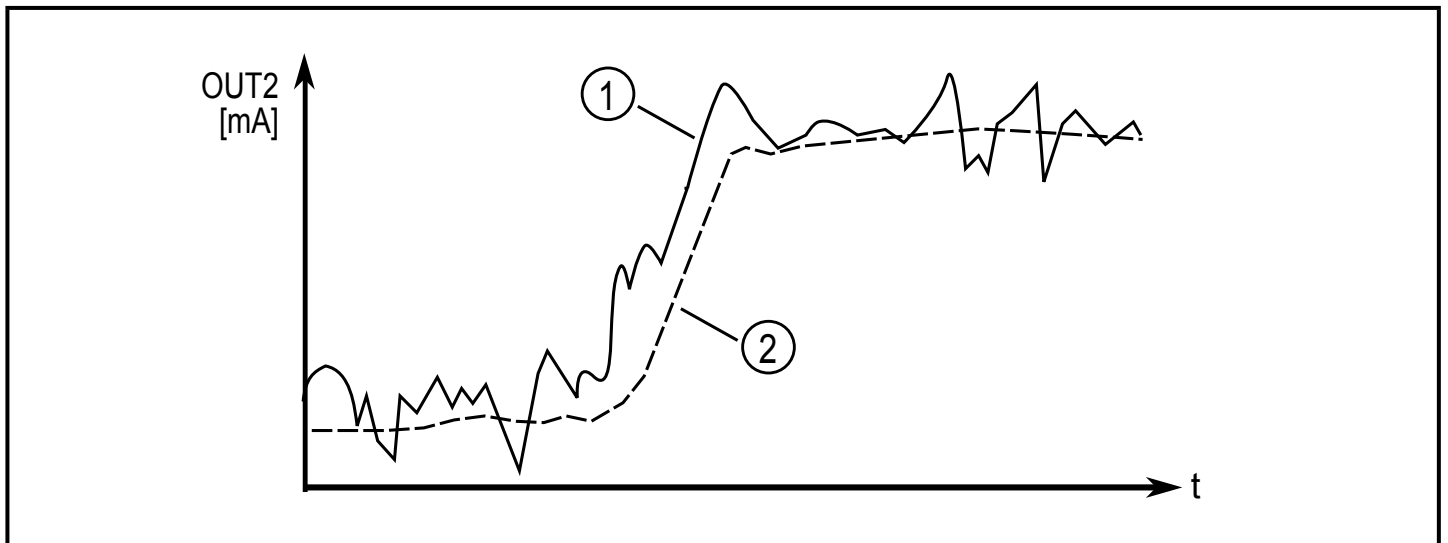

- (1) Output signal without smoothing function
- (2) Output signal with smoothing function

4.9 Peak-hold function

To detect cyclically occurring temperatures such as for objects passing by the infrared temperature sensor it is possible to set a hold time. During this hold time only the maximal measured value is displayed and provided.

It is recommended to set the hold time to approx. the 1.5 times the object cycle time.

The hold time [Phld] can be set to 0...600 s (→ 10.3.4 Set the peak-hold function).

4.10 IO-Link

This unit has an IO-Link communication interface which enables direct access to process and diagnostic data. In addition it is possible to set the parameters of the unit during operation. Operation of the unit via IO-Link interface requires an IO-Link capable module (IO-Link master).

With a PC, suitable IO-Link software and an IO-Link adapter cable communication is possible when the system is not in operation.

The IODDs necessary for the configuration of the unit, detailed information about process data structure, diagnostic information, parameter addresses and the

necessary information about the required IO-Link hardware and software can be found at www.ifm.com.

5 Installation

► Secure the unit with a suitable bracket.

Accessories → www.ifm.com.



At an ambient temperature $> 65\text{ °C}$ the unit must be cooled or protected against the radiated heat by means of a shielding screen.

For correct orientation observe the measuring segment diameter (1) and the measuring distance (2). The object to be measured should not be smaller than the measured spot diameter:

UK

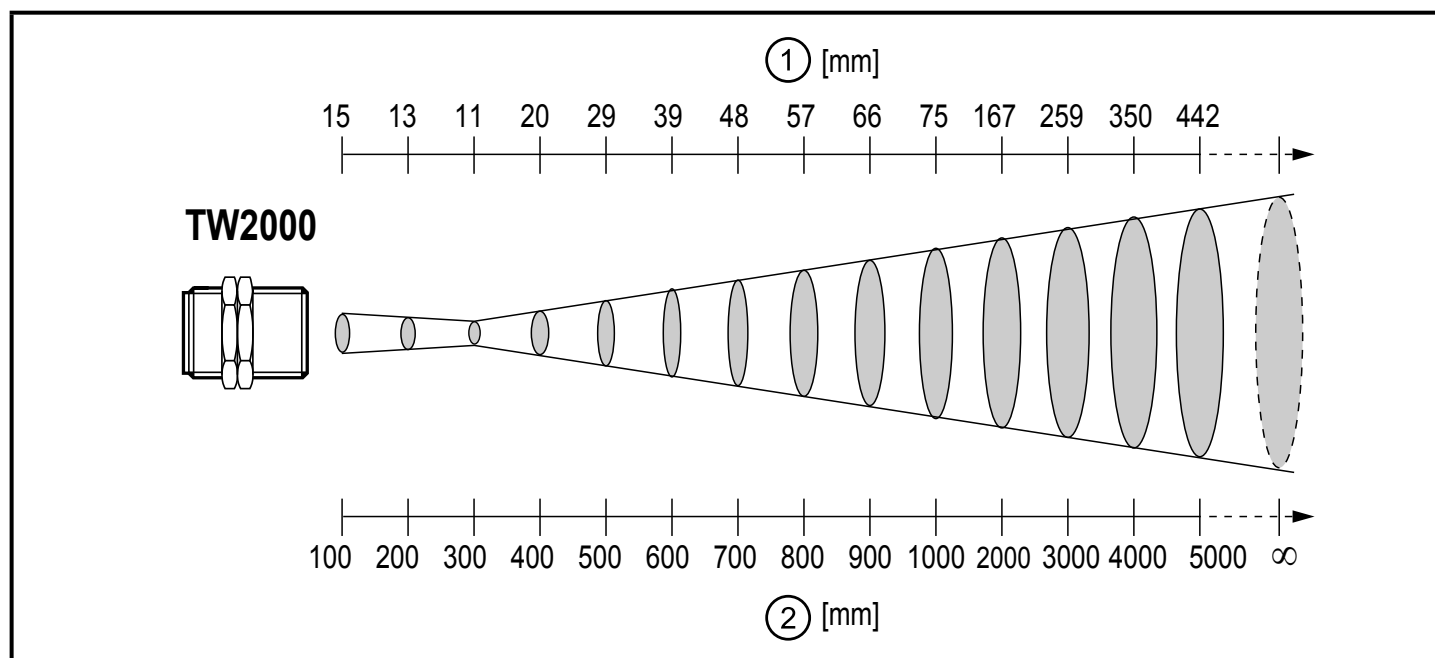

(1) Measuring segment diameter

(2) Measuring distance

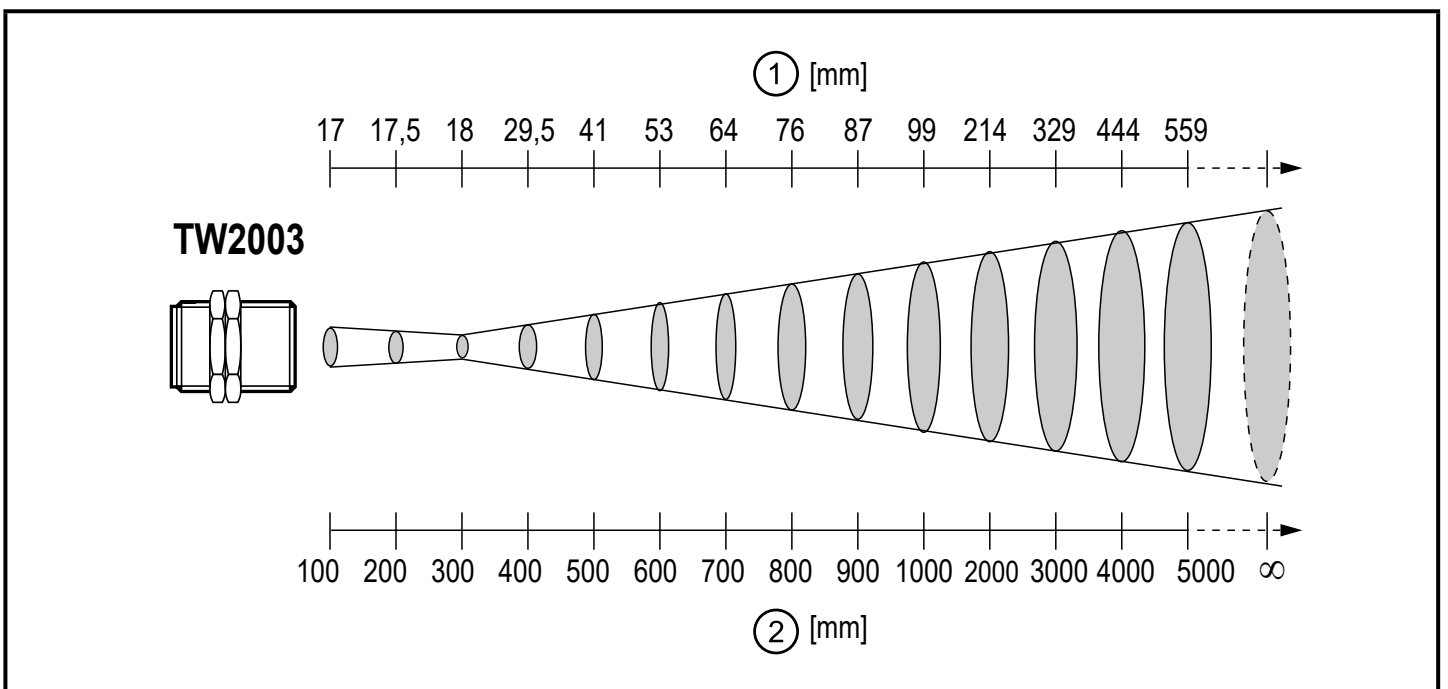
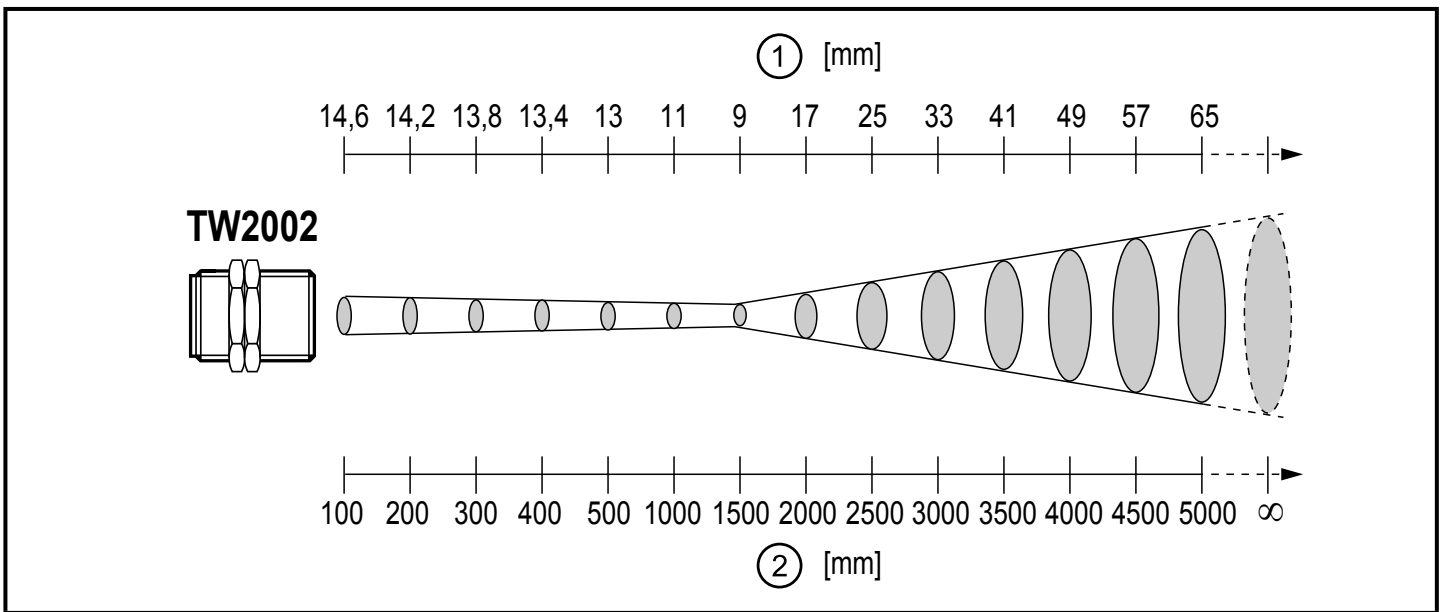
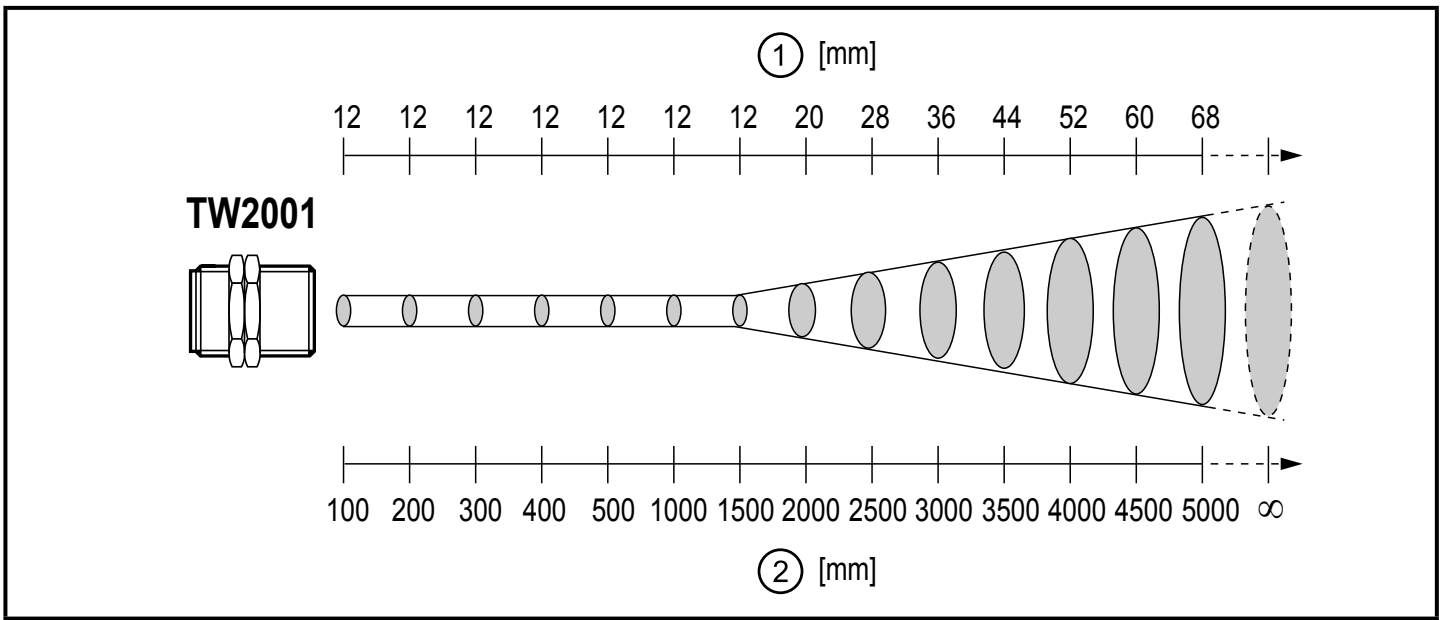

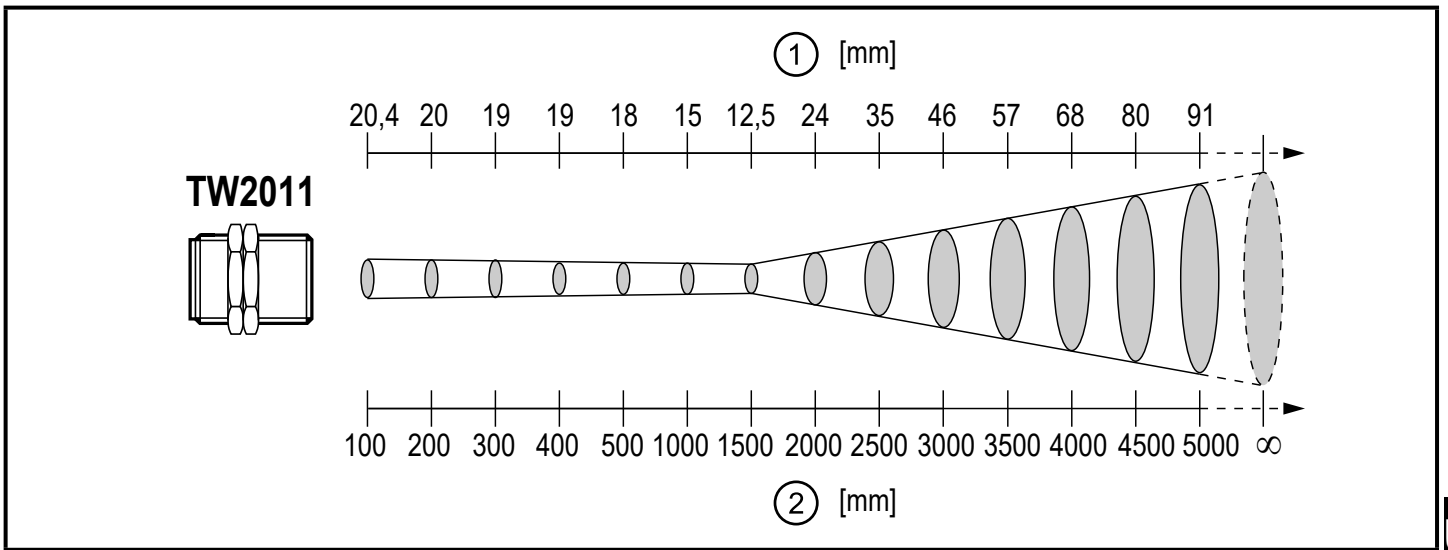

UK



For types TW21xx:

- ▶ Align the measuring head so that the green LED pilot light is visible on the object to be measured as a round light spot.

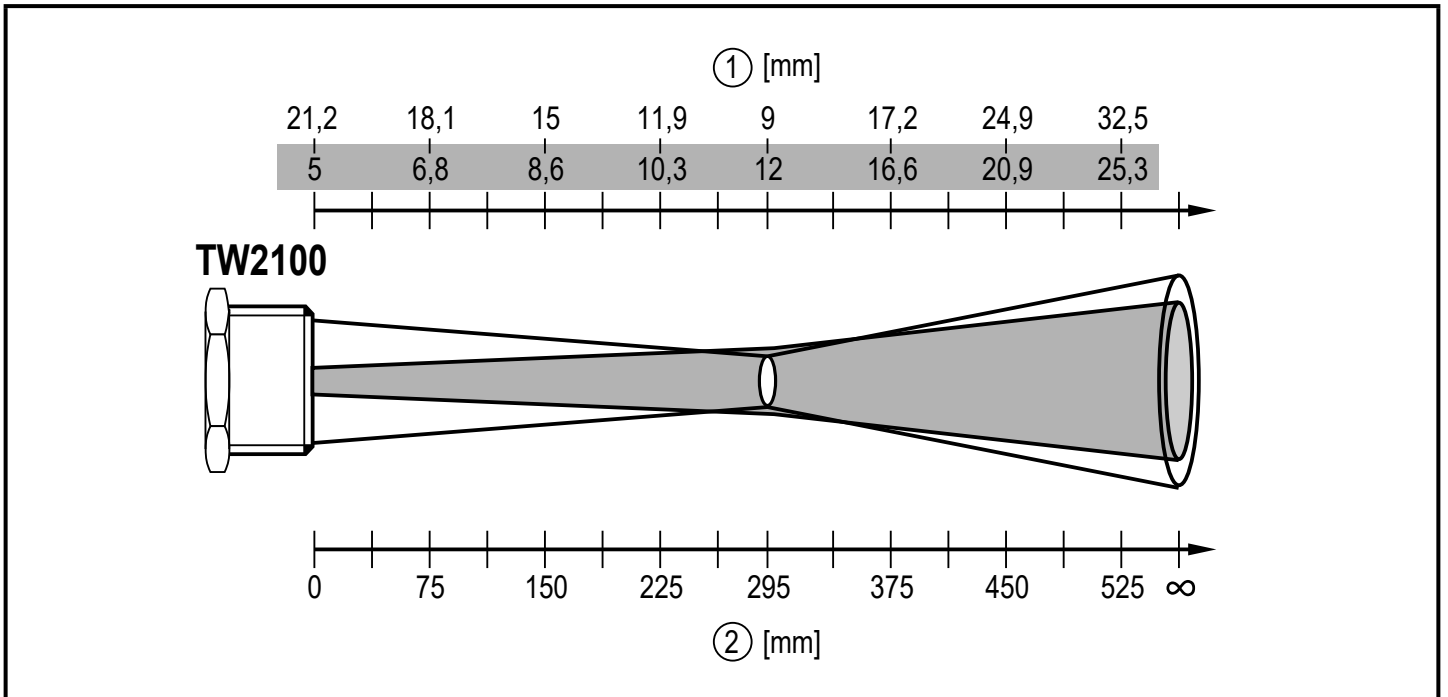

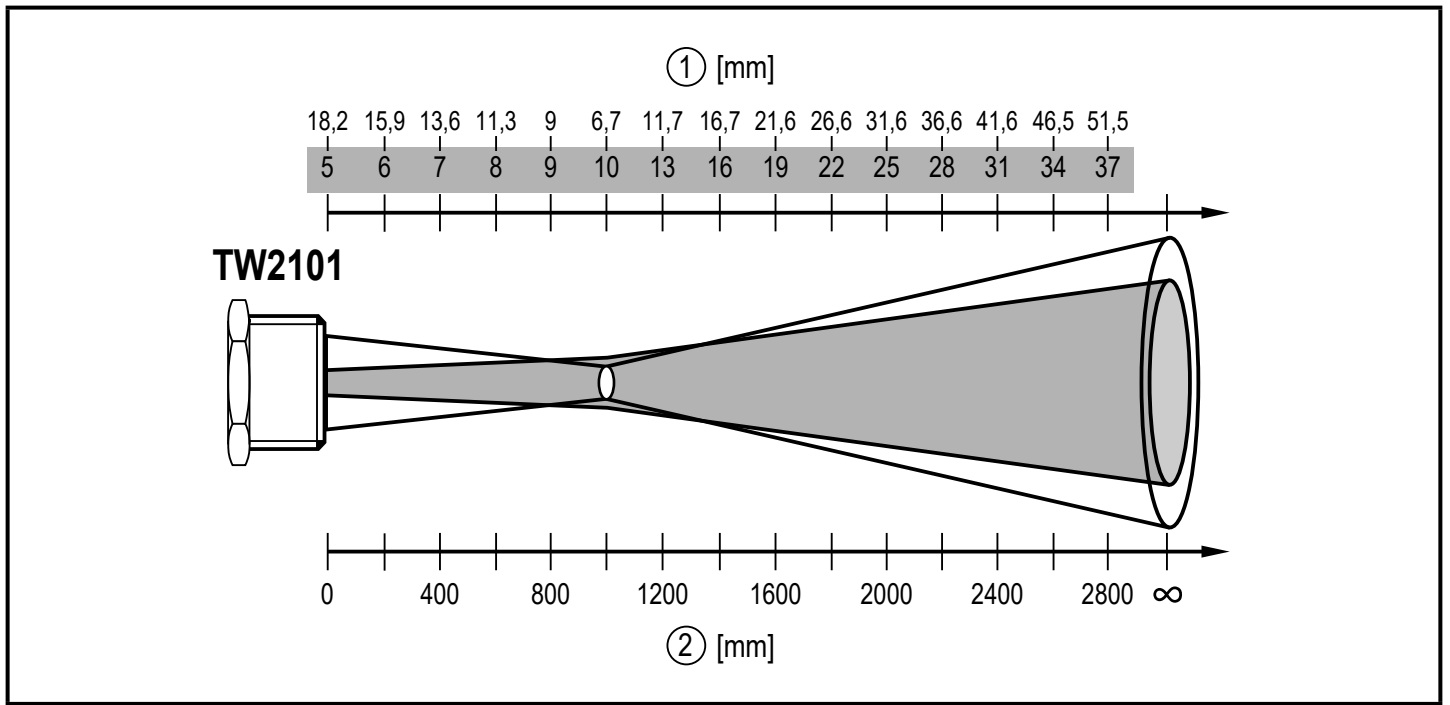

(1) Measuring segment diameter; Diameter LED pilot light
 (2) Measuring distance

6 Electrical connection



The unit must be connected by a qualified electrician.

The national and international regulations for the installation of electrical equipment must be adhered to.

Voltage supply according to EN 50178, SELV, PELV.



The unit is supplied with 24 V DC (18...32 V DC) low voltage.

The voltage supply must comply with the provisions of protective low voltage EN 50178, SELV, PELV.

► Disconnect power.

► Connect the unit as follows:

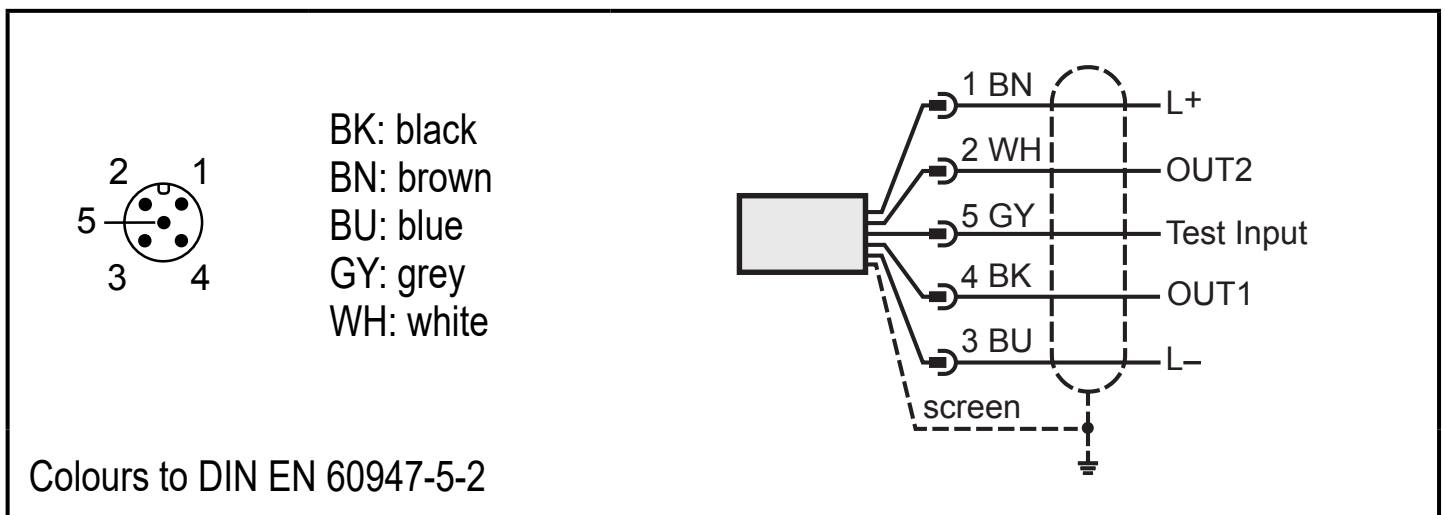

Pin 1	L+
Pin 2 (OUT2)	analogue output
Pin 3	L-
Pin 4 (OUT1)	switching output IO-Link
Pin 5	test input



► Use a screened cable. The screen of the cable must be connected to the sensor housing.



When inductive loads are switched:

► Use a free wheel diode.

6.1 Screening and grounding

The unit housing is connected to the cable screen via the connector.

If there are potential differences between the grounding points, a compensation current can flow across the screen connected at both sides. In this case, lay an additional cable for equalisation of the potential.

To avoid compensation currents the unit can also be installed as isolated. The screen must then be connected to the functional earth of the plant.



Without isolated installation and without potential equalisation the maximum interference voltage on the infrared temperature sensor may be 32 V.

7 Operating and display elements

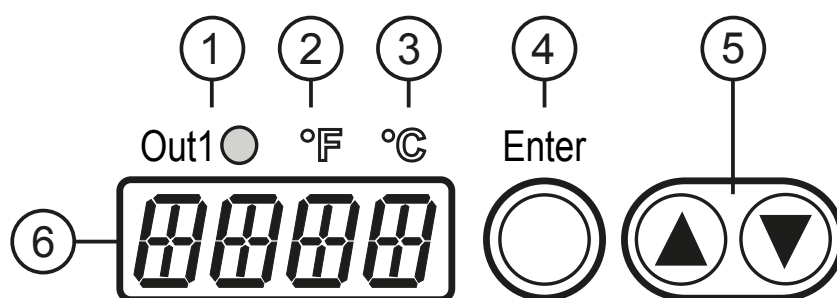

1 to 3: Indicator LEDs

LED 1 = switching status of the output

LED 2 = temperature indication in °F

LED 3 = temperature indication in °C

4: [Enter] button

- Selection of the parameters
- Reading the set values
- Confirmation of the parameter values

5: Set buttons [▲] and [▼]

- Selection of the parameters
- Activation of the setting functions
- Changing the parameter values
- Change of the display unit in the normal operating mode (RUN mode)
- Locking / unlocking

6: Alphanumeric display, 4 digits

- Display of the temperature value
- Display of the parameters and configuration
- Error indication

8 Menu

8.1 Menu structure

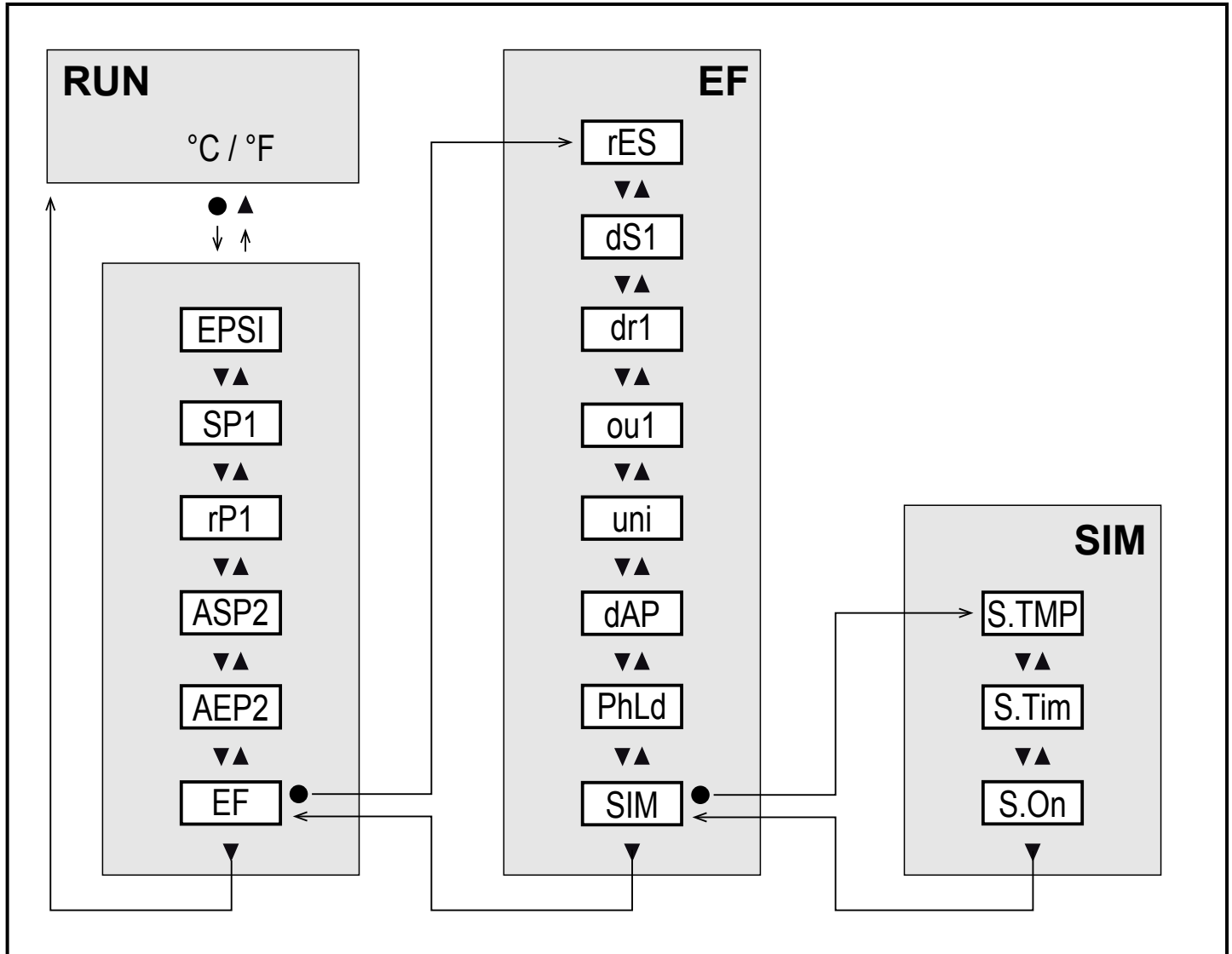

8.2 Explanation main menu

Parameter	Function and setting options
EPSI	Emissivity: Correction of the radiation characteristics of the object to be measured
SP1	Switch point 1 = upper limit value for the switching output OUT1
rP1	Reset point = lower limit value for the switching output OUT1

ASP2	Analogue start point with scaled measuring range for the analogue output OUT2
AEP2	Analogue end point with scaled measuring range for the analogue output OUT2
EF	Opening the lower menu level "Extended functions"

8.3 Explanation extended functions (EF)

Parameters	Function and setting options
rES	Reset to factory settings
dS1	Switch-on delay for OUT1: Value in seconds (maximum 10 s in steps of 0.1 s)
dr1	Switch-off delay for OUT1: Value in seconds (maximum 10 s in steps of 0.1 s)
ou1	Output function for OUT1: - Hno: Hysteresis normally open - Hnc: hysteresis normally closed
uni	Standard unit of measurement for temperature: °F or °C
dAP	Damping for the temperature display, switching output and analogue output
PhLd	Configuration of the peak-hold function
SIM	Opening of the lower menu level "Simulation"

8.4 Submenu simulation (SIM)

Parameter	Function and setting options
S.TMP	Simulated temperature value
S.Tim	Duration of the simulation in minutes
S.On	Start of the simulation: - On (simulation starts) - OFF (simulation inactive)

9 Set-up

When the supply voltage is switched on for the first time or after reset of the parameters to factory setting, [̄̄̄̄] is displayed. The emissivity has to be set:

▶ Press [Enter].

[EPSI] is indicated in the display.

▶ Press [Enter].

> [nonE] is indicated in the display.

▶ Press and hold [▼] until the requested value is indicated

▶ Press [Enter]

> The current temperature value is displayed. Now the unit operates permanently with the set emissivity.

When the emissivity has been set and the supply voltage has been switched on, the device performs an internal initialisation and self-diagnostics. After approx. 0.5 seconds the unit is ready for operation and starts the measurement and evaluation function.

10 Parameter setting

Parameters can be set before installation or during operation.



If you change parameters during operation, this will influence the function of the plant.



▶ Ensure that there will be no malfunctions in your plant.

During parameter setting the unit remains in the operating mode. It continues to monitor with the existing parameter until the parameter setting has been completed.

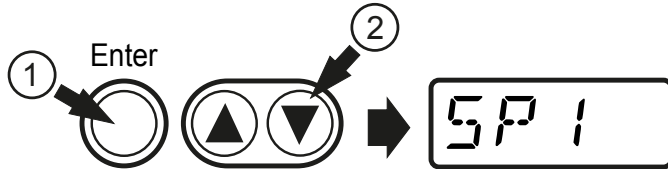

The parameters can also be set via the IO-Link interface (→ 4.10 IO-Link).

10.1 Parameter setting in general

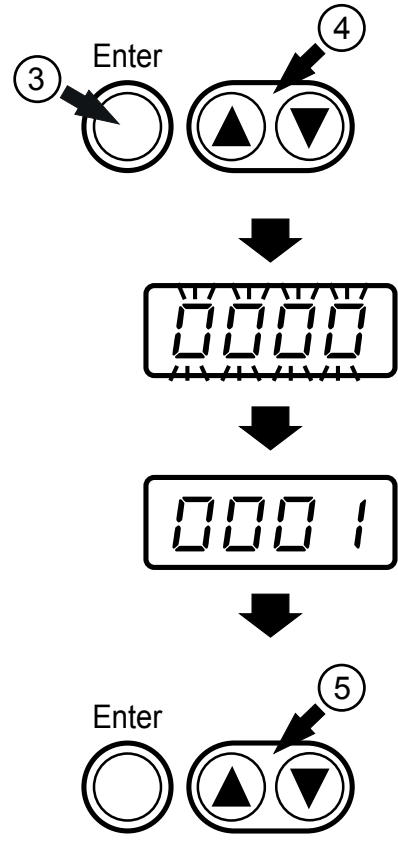
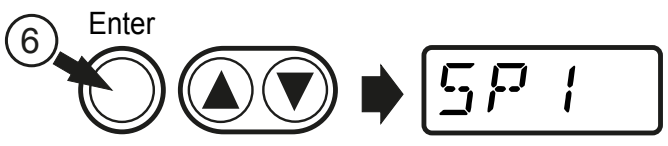
<p>Select parameter</p> <ol style="list-style-type: none"> 1. Briefly press [Enter]. 2. Press [▲] or [▼] until the requested parameter is displayed. 	
<p>Changing the parameter value</p> <ol style="list-style-type: none"> 3. Briefly press [Enter]. > The currently set value is displayed. 4. Keep [▲] or [▼] pressed for 1 s. > Display flashes first, then permanent. 5. Change value by pressing [▲] or [▼]. <p> Keep [▲] or [▼] pressed. > Faster cycle of the numerical values.</p>	
<p>Acknowledge parameter value</p> <ol style="list-style-type: none"> 6. Briefly press [Enter]. > The parameter is displayed again. The new setting value is saved. 	
<p>Finish parameter setting and change to the process value display:</p> <ul style="list-style-type: none"> ▶ wait for 30 seconds <p>or</p> <ul style="list-style-type: none"> ▶ change from the submenu to the main menu, from the main menu to the process value display with [▲] or [▼]. 	

10.1.1 Switching between the menu levels

Change to the submenu	▶ Select [EF] or [SIM] and switch to the submenu by pressing [Enter].
Back to the process value display	▶ Change from the submenu to the main menu, from the main menu to the process value display with [▲] or [▼] or timeout: ▶ wait for 30 seconds or escape function: ▶ press [▲] and [▼] simultaneously.

UK

10.1.2 Locking / unlocking

The unit can be locked electronically to prevent unintentional settings. On delivery: not locked.



<p>Locking</p> <ul style="list-style-type: none"> ▶ Make sure that the unit is in the normal operating mode. ▶ Press [▲] and [▼] simultaneously for 10 s. <p>> [Loc] is displayed.</p> <p> During operation: [Loc] is briefly displayed if you try to change parameter values.</p> <p>Unlocking</p> <ul style="list-style-type: none"> ▶ Press [▲] and [▼] simultaneously for 10 s. <p>> [uLoc] is displayed.</p>	<p>[Loc] [uLoc]</p>
--	-------------------------

10.1.3 Timeout

If no button is pressed for 30 s during parameter setting, the unit returns to the operating mode with unchanged parameter.

10.2 Settings for temperature monitoring

10.2.1 Setting the degree of emissivity

<p>▶ Select [EPSI] and set the emissivity using [▲] or [▼].</p> <p> When [▲] or [▼] is released, the changed target temperature is displayed for approx. 2 s. After that, EPSI is displayed again. Confirm the requested value with [Enter].</p> <p>TW2000 / TW2003 / TW2100 – Set emissivity with the supplied label (up to maximum 250 °C):</p> <p> Ensure during the following measurements that the temperature of the object to be measured remains constant.</p> <ul style="list-style-type: none"> ▶ Select [EPSI] and set the emissivity to 94 %. ▶ Apply the label to the object to be measured and measure the temperature with the infrared temperature sensor (= reference temperature). ▶ Remove the label and measure the temperature of the object again. > Displayed temperature deviates from the reference temperature. ▶ Select [EPSI] and change the emissivity. ▶ Measure the object again. ▶ Repeat the process until the displayed value corresponds to the determined reference temperature. <p> Decreasing the emissivity leads to an increased temperature display and vice versa.</p>	<p>Main menu: [EPSI]</p>
--	------------------------------

10.2.2 Emissivity for TW2000 / TW2003 / TW2100

($\lambda = 8...14 \mu\text{m}$)

Material	[%]
Alumina	76
Asphalt	90...98
Baking oven	96
Concrete	55...65
Bitumen (roofing cardboard)	96
Bread in the oven	88
Iron oxide	85...89
Enamel	84...88
Soil	92...96
Paints and lacquers, shiny	92

Material	[%]
Lime plaster	91
Clinker brick, glazed	75
Table stove	95
Copper, oxidised	78
Plastics, opaque	65...95
Leather	75...80
Marble	94
Brass, oxidised	56...64
Paper	70...94
Sand	90

Material	[%]
Paints and lacquers, matt	96
Plaster	80...90
Glass	85...95
Graphite	98
Rubber, black	94
Skin, human	98
Radiator	80...85
Wood	80...90

Material	[%]
Chamotte	75
Black body	100
Steel, antirust	45
Steel, red oxidised	69
Textiles	75...88
Water	92...98
Cement	90
Brick	93...96

UK

10.2.3 Emissivities for TW2001, TW2101, TW2011, TW2002

Material	TW2001, TW2101, TW2011 ($\lambda = 1.1...1.7 \mu\text{m}$)	TW2002 ($\lambda = 0.78...1.06 \mu\text{m}$)
	[%]	[%]
Aluminium, polished	5	15
Aluminium, finished	10	25
Asbestos cement	60	70
Bronze, polished	1	3
Bronze, finished	15	30
Chromium, blank	15	30
Iron, heavily scaled	90	95
Iron, rolling skin	75	90
Iron, molten	15	30
Gold and silver	1	2
Graphite, finished	85	90
Copper, oxidised	70	90
Brass, oxidised (tarnished)	50	70
Nickel	8	20
Porcelain, glazed	50	60
Porcelain, rough	75	85
Soot	90	95
Chamotte	40	50

	TW2001, TW2101, TW2011 ($\lambda = 1.1...1.7 \mu\text{m}$)	TW2002 ($\lambda = 0.78...1.06 \mu\text{m}$)
Material	[%]	[%]
Slag	80	85
Black body	100	100
Pottery, glazed	85	90
Brick	85	90
zinc	40	60

10.2.4 Settings for limit value monitoring with OUT1

<ul style="list-style-type: none"> ▶ Select [ou1] and set the switching function: <ul style="list-style-type: none"> - Hno = hysteresis function/NO, - Hnc = hysteresis function/NC ▶ Select [SP1] and set the value at which the output is set. ▶ Select [rP1] and set the value at which the output is reset. 	Menu EF: [ou1] Main menu: [SP1] [rP1]
---	---

10.2.5 Set the analogue signal for OUT2

<ul style="list-style-type: none"> ▶ Select [ASP2] and set the value at which the minimum value is provided. ▶ Select [AEP2] and set the value at which the maximum value is provided. 	Main menu: [ASP2] [AEP2]
--	--------------------------------

10.3 User settings (optional)

10.3.1 Set the standard unit of measurement for temperature

<ul style="list-style-type: none"> ▶ Select [uni] and set the unit of measurement: [°C or °F]. 	Menu EF: [uni]
---	-------------------

10.3.2 Set delay time for OUT1

[dS1] = switch-on delay, [dr1] = switch-off delay. <ul style="list-style-type: none"> ▶ Select [dS1] or [dr1] and set a value in seconds (at 0.0 the delay time is not active). 	Menu EF: [dS1] [dr1]
---	----------------------------

10.3.3 Set the measured value damping

<ul style="list-style-type: none"> ▶ Select [dAP] and set a damping constant in seconds: 0...600 s in steps of 0.1 s. 	Menu EF: [dAP]
--	-------------------

10.3.4 Set the peak-hold function

▶ Select [Phld] and set the hold time in seconds: 0...600 s in steps of 0.1 s.	Menu EF: [PhLd]
---	--------------------

10.3.5 Setting the simulation function

▶ Select [S.TMP] and set the temperature value to be simulated. ▶ Select [S.Tim] and set the time of the simulation in minutes. ▶ Select [S.On] and set the function: - On: The simulation starts. The values are simulated for the time set at [S.Tim]. SIM]is displayed simultaneously with the process values. Cancel with [Enter]. - OFF: The simulation is not active.	Menu SIM: [S.TMP] [S.Tim] [S.On]
---	---

UK

10.4 Service functions

10.4.1 Reset all parameters to factory setting

▶ Select [rES]. ▶ Briefly press [Enter]. ▶ Keep [▲] or [▼] pressed. > [----] is displayed. ▶ Briefly press [Enter]. > [≡ ≡ ≡ ≡] is displayed. The emissivity has to be reset (→ 10.2.1). We recommend taking down your own settings in a table before carrying out a reset (→ 15 Factory setting).	Menu EF: [rES]
--	-------------------

11 Operation

11.1 Changing the display unit in the Run mode

The temperature is displayed in the set standard unit of measurement (→ 10.3.1). The display unit can be changed by pressing the pushbutton:

- ▶ Briefly press [▼] or [▲] in the Run mode.
- > The process value is displayed in the other temperature unit for 30 s; the respective LED is lit.

11.2 Read the set parameters

- ▶ Briefly press [Enter].
- ▶ Press [▼] or [▲] until the required parameter is displayed.
- ▶ Briefly press [Enter].

- > The unit displays the currently set parameter value for 30 seconds. Then it returns to the Run mode.

12 Technical data and scale drawing

Technical data and scale drawing at www.ifm.com.

13 Troubleshooting

Display	Error
[SC1] flashes at 2 Hz LED OUT1 flashes at 4 Hz	Overload switching output
[ot] and the process value change at 0.5 Hz	Overtemperature in the unit (> 75 °C)
[ot] and the process value change with 0.5 Hz LED OUT1 flashes at 4 Hz	Overtemperature in the unit (> 120 °C) > The switching output is deactivated.
LED OUT1 flashes at 2 Hz	Faulty connection of the supply voltage
No display	Supply voltage too low
[UL]	Measuring range not reached
[OL]	Measuring range exceeded

14 Maintenance, repair and disposal

A soiled lens leads to a wrong display of the measured value.

- ▶ Check the lens regularly and clean it, if required:
 - Remove dust by blowing or use a soft brush.
 - Use clean, soft and lint-free cloths or those offered on the market for lens cleaning.
 - For heavier contamination, use washing-up liquid or liquid soap. Then carefully rinse with clear water. Hold the lens downwards.
 - Exert only little pressure on the lens during cleaning to avoid scratches.

15 Factory setting

Parameter	Factory setting					User setting
	TW2000 TW2100	TW2003	TW2001 TW2101	TW2002	TW2011	
SP1	250 °C	50 °C	500 °C	1000 °C	550 °C	
rP1	230 °C	45 °C	480 °C	960 °C	530 °C	
ASP2	0 °C	-30 °C	250 °C	500 °C	300 °C	
AEP2	1000 °C	300 °C	1600 °C	2500 °C	1600 °C	
rES	-					
dS1	0.0 s					
dr1	0.0 s					
ou1	Hno					
uni	°C					
dAP	0.0 s					
PhLd	0					
EPSI	None					
tESt	OFF					

UK

More information at www.ifm.com