



CE

Operating instructions
Electronic pressure sensor

PN7x72

UK

11420493 / 00 10 / 2021

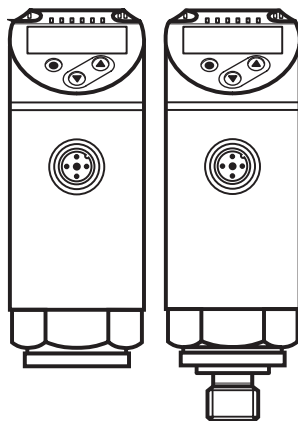

Contents

1	Preliminary note.....	3
1.1	Symbols used.....	3
2	Safety instructions.....	4
3	Functions and features.....	5
3.1	Applications.....	5
4	Function.....	5
4.1	Operating modes.....	6
4.2	Communication, parameter setting, evaluation.....	7
4.3	Switching function.....	8
4.4	IO-Link.....	9
4.4.1	General information.....	9
4.4.2	Functions only available via IO-Link communication.....	9
5	Installation.....	10
6	Electrical connection.....	10
7	Operating and display elements.....	11
8	Menu.....	12
8.1	Menu structure: main menu.....	12
8.2	Explanation of the menu.....	13
8.2.1	Explanation of menu level 1.....	13
8.2.2	Explanation of menu level 2.....	13
9	Parameter setting.....	14
9.1	Parameter setting in general.....	14
9.2	Define operating mode (optional).....	17
9.3	Configure display (optional).....	17
9.4	Set output signals.....	18
9.4.1	Set output functions.....	18
9.4.2	Define switching limits for the hysteresis function.....	18
9.4.3	Define switching limits for the window function.....	18
9.5	User settings (optional).....	19
9.5.1	Set delay time for the switching outputs.....	19
9.5.2	Set output logic for the switching outputs.....	20
9.5.3	Set damping for the switching signal.....	20

9.5.4	Reset all parameters to factory setting	20
9.5.5	Set colour change of the display	21
9.5.6	Graphical depiction of the colour change of the display	22
9.6	Diagnostic functions	24
9.6.1	Read min/max values for the system pressure	24
9.6.2	Read overload processes	25
10	Operation	25
10.1	Read set parameters	25
10.2	Self-diagnostics / fault indications	25
11	Technical data	27
11.1	Setting ranges	27
11.1.1	Setting ranges in operating mode 2	27
11.1.2	Setting ranges in operating mode 3	27
11.2	Further technical data	27
12	Factory setting	28

1 Preliminary note

1.1 Symbols used

- ▶ Instruction
- > Reaction, result
- [...] Designation of keys, buttons or indications
- Cross-reference



Important note

Non-compliance may result in malfunction or interference



Information\Supplementary note

2 Safety instructions

- The device described is a subcomponent for integration into a system.
 - The manufacturer is responsible for the safety of the system.
 - The system manufacturer undertakes to perform a risk assessment and to create a documentation in accordance with legal and normative requirements to be provided to the operator and user of the system. This documentation must contain all necessary information and safety instructions for the operator, the user and, if applicable, for any service personnel authorised by the manufacturer of the system.
- Read this document before setting up the product and keep it during the entire service life.
- The product must be suitable for the corresponding applications and environmental conditions without any restrictions.
- Only use the product for its intended purpose (→ Functions and features).
- Only use the product for permissible media (→ Technical data).
- If the operating instructions or the technical data are not adhered to, personal injury and/or damage to property may occur.
- The manufacturer assumes no liability or warranty for any consequences caused by tampering with the product or incorrect use by the operator.
- Installation, electrical connection, set-up, programming, configuration, operation and maintenance of the product must be carried out by personnel qualified and authorised for the respective activity.
- Protect units and cables against damage.

3 Functions and features

The device monitors the system pressure of machines and installations.

3.1 Applications

Type of pressure: relative pressure



Information on pressure rating and bursting pressure → data sheet.



Avoid static and dynamic overpressure exceeding the specified overload pressure by taking appropriate measures. The indicated bursting pressure must not be exceeded.

Even if the bursting pressure is exceeded only for a short time, the unit may be destroyed. **ATTENTION: Risk of injury!**



The units are vacuum resistant.



Pressure Equipment Directive (PED):

The units comply with the Pressure Equipment Directive and are designed and manufactured for group 2 fluids in accordance with the sound engineering practice.

Use of group 1 fluids on request!

4 Function

- The unit displays the current system pressure.
- It generates output signals according to the operating mode and the parameter setting.
- Moreover, it provides the process data via IO-Link.
- The unit is designed for fully bidirectional communication.

So the following options are possible:

- Remote display: reading and display of the current system pressure.
- Remote parameter setting: reading and changing the current parameter setting.
- IO-Link parameter setting (→ 4.4)

4.1 Operating modes

Operating mode 1



If operating mode 1 is used, note the operation instructions of the old devices, as the device functions may differ from these operating instructions. Operating instructions: → www.ifm.com

Description	In this operating mode the sensor behaves like its previous version. The following old devices are concerned: PN7002.
Application	To ensure compatibility to old devices if sensors are replaced.
IODD designation	IO Device Description - IODD: at www.ifm.com in the download area of the corresponding old device.

Operating mode 2

Description	Operating mode on delivery.
Application	Standard applications
IODD designation	Example PN7072 factory setting / (CMPT=2): at www.ifm.com in the download area of the corresponding article.

Operating mode 3

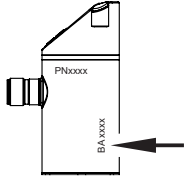
Description	<p>High IO-Link process value and parameter resolution (device-specific: see operating mode of the corresponding IODD). The menu items [ou1] and [ou2] are extended by the setting option [OFF] (→ 9.4.1). IO-Link standard command "Flash on" is available (→ 4.4.2). The following IO-Link markings are available: Application Specific Tag, Function Tag and Location Tag (→ 4.4.2).</p> <p> This operating mode is available as of device status BA. For the device status see the labelling on the device.</p> <div style="text-align: center;">  </div>
Application	<p>Improved controllability via IO-Link. Highly granular setting of set and reset points.</p>
IODD designation	<p>Example PN7072 Status_B High Resolution / (CMPT=3): at www.ifm.com in the download area of the corresponding article.</p>

 Manual operating mode selection, see (→ 9.2),
selection of the operating mode via IO-Link interface see
→ additional document: selection of the operating mode, at www.ifm.com.

4.2 Communication, parameter setting, evaluation

OUT1 (pin 4)	<ul style="list-style-type: none"> • Switching signal for system pressure limit • Communication via IO-Link
OUT2 (pin 2)	<ul style="list-style-type: none"> • Switching signal for system pressure limit

4.3 Switching function

OUTx changes its switching status if it is above or below the set switching limits (SPx, rPx). The following switching functions can be selected:

- Hysteresis function / normally open: [OUx] = [Hno] (→ Fig. 1)
- Hysteresis function / normally closed: [OUx] = [Hnc] (→ Fig. 1)

First the set point (SPx) is set, then the reset point (rPx).

The hysteresis defined remains even if SPx is changed again.

- Window function / normally open: [OUx] = [Fno] (→ Fig. 2).
- Window function / normally closed: [OUx] = [Fnc] (→ Fig. 2).

The width of the window can be set by means of the difference between FHx and FLx. FHx = upper value, FLx = lower value.

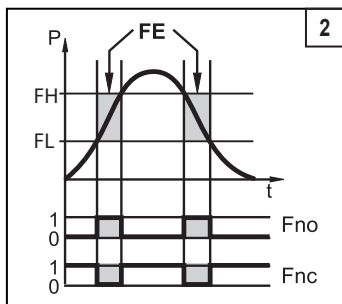
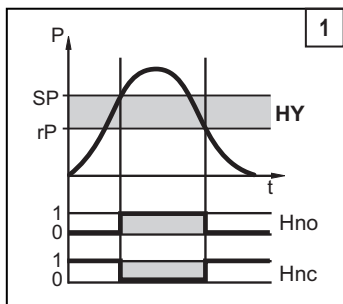

P = system pressure; HY = hysteresis; FE = window



When set to the window function the set and reset points have a fixed hysteresis of 0.25 % of the measuring span.

4.4 IO-Link

4.4.1 General information

The device has an IO-Link communication interface which requires an IO-Link-capable module (IO-Link master).

The IO-Link interface enables direct access to the process and diagnostic data and provides the possibility to set the parameters of the unit during operation.

In addition, communication is possible via a point-to-point connection with a USB adapter cable.

The IODDs necessary for the configuration of the unit, detailed information about process data structure, diagnostic information, parameter addresses and the necessary information about the required IO-Link hardware and software can be found at www.ifm.com.

4.4.2 Functions only available via IO-Link communication

- HIPC: Number of overload processes (→ 9.6.2).
- HIPS: Threshold for the overload counter (→ 9.6.2).
- Flashing: Via this standard command, the sensor can be localised in the plant. When the command is used, the switching status LEDs will flash and the device display will signal "IO-L".
(Function only available in operating mode [3]).
- Application Specific Tag: Freely definable text assigned to the unit.
- Function Tag: Freely definable text describing the device function in the plant.
(Function only available in operating mode [3]).
- Location Tag: Freely definable text describing the installation location in the plant. (Function only available in operating mode [3]).

For more detailed information refer to the device-specific IO Device Description PDF at www.ifm.com.

5 Installation



Before installing and removing the unit: Make sure that no pressure is applied to the system.

- ▶ Insert the unit in a G $\frac{1}{4}$ process connection.
- ▶ Tighten firmly. Recommended tightening torque: 25...35 Nm

The sensor housing can be rotated by 345° with regard to the process connection.



Do not rotate past the end stop!

6 Electrical connection



The unit must be connected by a qualified electrician.

The national and international regulations for the installation of electrical equipment must be adhered to.

Voltage supply according to EN 50178, SELV, PELV.

- ▶ Disconnect power.
- ▶ Connect the unit as follows:

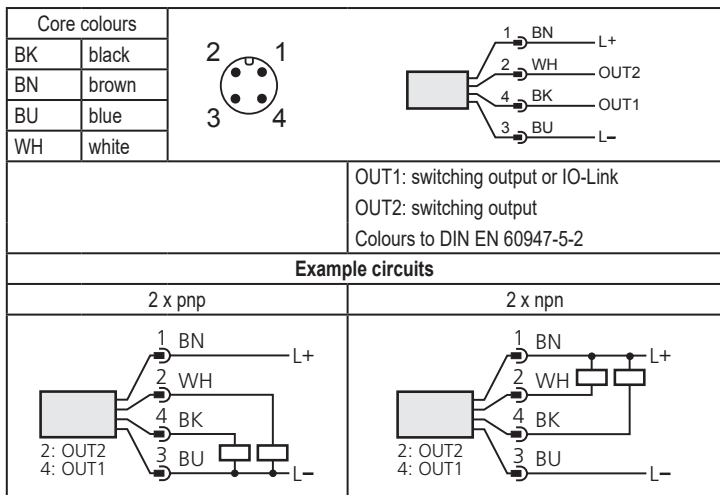

7 Operating and display elements

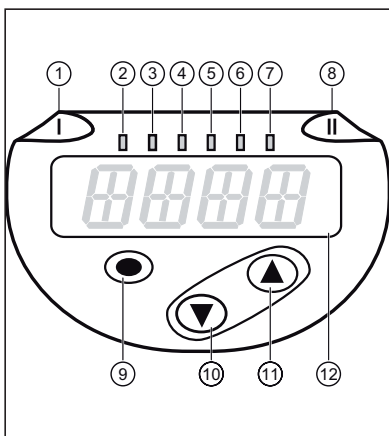

UK

1 to 8: Indicator LEDs	
LED 1	Switching status OUT1 (on if output 1 is switched).
LED 8	Switching status OUT2 (on if output 2 is switched).
LEDs 2 - 7	System pressure in the indicated unit of measurement.
9: Enter button [●]	
- Selection of the parameters and acknowledgement of the parameter values.	
10 to 11: Arrow keys up [▲] and down [▼]	
- Setting of the parameter values (scrolling by holding pressed, incrementally by pressing once).	
12: Alphanumeric display, 4 digits	
- Display of the current system pressure.	
- Display of the parameters and parameter values.	

8 Menu

8.1 Menu structure: main menu

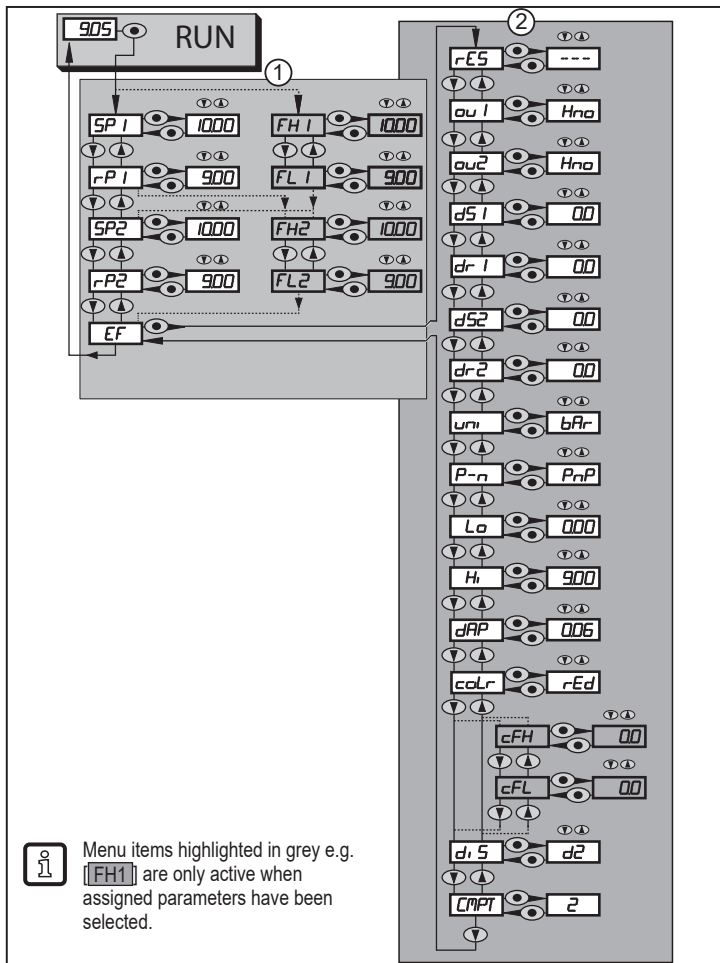

8.2 Explanation of the menu

8.2.1 Explanation of menu level 1

SPx/rPx	Upper / lower limit for system pressure at which OUTx switches with hysteresis setting. SPx/rPx is displayed if the parameter [Hno] or [Hnc] for OUTx was set in the extended functions "EF" menu.
FHx/FLx	Upper / lower limit for system pressure at which OUTx switches with window setting. FHx/FLx is displayed if the parameter [Fno] or [Fnc] for OUTx was set in the extended functions "EF" menu.
EF	Extended functions / opening of menu level 2.

UK

8.2.2 Explanation of menu level 2

rES	Restore factory setting.
ou1	Output function for OUT1: <ul style="list-style-type: none">• Switching signal for the pressure limits: hysteresis function [H ..] or window function [F ..], either normally open [. no] or normally closed [. nc] each.• Output off [OFF] (function only available in operating mode [3]).
ou2	Output function for OUT2: <ul style="list-style-type: none">• Switching signal for the pressure limits: hysteresis function [H . .] or window function [F . .] as normally open (. no) or normally closed (. nc) each.• Output off [OFF] (function only available in operating mode [3]).
dS1 / dS2	Switch-on delay for OUT1 or OUT2.
dr1 / dr2	Switch-off delay for OUT1 / OUT2.
uni	Standard unit of measurement for system pressure (display): [bAr] / [MPa], [PSI].
P-n	Output logic: PnP / nPn.
Lo	Minimum value memory for system pressure.
Hi	Maximum value memory for system pressure.
dAP	Damping of the measured signal.
coLr	Assignment of the display colours "red" and "green" within the measuring range.
cFH / cFL	Upper / lower value for colour change. Parameter only active after selection of a freely definable colour window in the coLr parameter: [r-cF] or [G-cF].
diS	Update rate and orientation of the display.
CMPT	Selection of the operating mode.

9 Parameter setting

During parameter setting the unit remains in the operating mode. It continues to monitor with the existing parameters until the parameter setting has been completed.

9.1 Parameter setting in general

3 steps must be taken for each parameter setting:

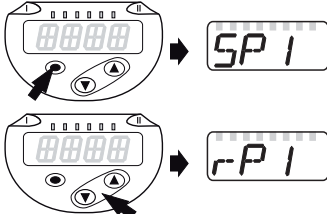
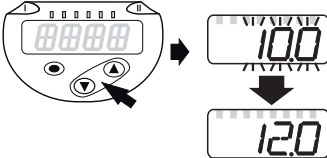
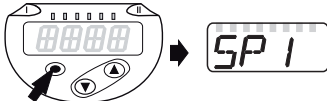
<p>1 Select parameter</p> <ul style="list-style-type: none">▶ Press [●] to get to the menu.▶ Press [▲] or [▼] until the required parameter is displayed.	
<p>2 Set parameter value</p> <ul style="list-style-type: none">▶ Press [●] to edit the selected parameter.▶ Press [▲] or [▼] for at least 1 s.> After 1 s: setting value is changed: incrementally by pressing the button once or scrolling by keeping the button pressed.	
<p>Numerical values are incremented continuously with [▲] or decremented with [▼].</p>	
<p>3 Acknowledge parameter value</p> <ul style="list-style-type: none">▶ Briefly press [●].> The parameter is displayed again. The new setting value is saved.	
<p>Set other parameters</p> <ul style="list-style-type: none">▶ Press [▲] or [▼] until the required parameter is displayed.	
<p>Finish parameter setting</p> <ul style="list-style-type: none">▶ Press [▲] or [▼] several times until the current measured value is displayed or wait for 30 s.> The unit returns to the process value display.	



If [C.Loc] is displayed when an attempt is made to modify a parameter value, an IO-Link communication is active (temporary locking).



If [S.Loc] is displayed, the sensor is permanently locked via software. This locking can only be removed with a parameter setting software.

- Change from menu level 1 to menu level 2:

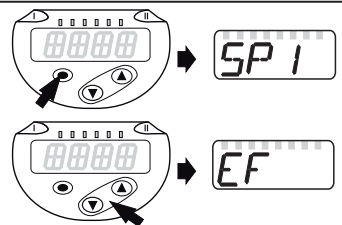
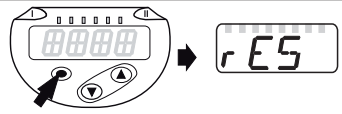
<ul style="list-style-type: none"> ▶ Press [●] to get to the menu. ▶ Press [▲] or [▼] until [EF] is displayed. 	
<ul style="list-style-type: none"> ▶ Press [●]. > The first parameter of the submenu is displayed (here: [rES]). 	

UK



Change from menu level 1 to menu level 2 when a parameter setting software is used:
Activate the [EF] button.

- Locking / unlocking

The unit can be locked electronically to prevent unintentional settings.

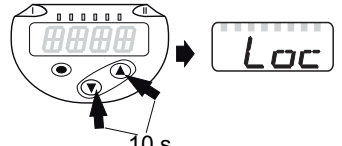
<ul style="list-style-type: none"> ▶ Make sure that the unit is in the normal operating mode. ▶ Press [▲] + [▼] simultaneously for 10 s. > [Loc] is displayed. 	
<p>During operation: [Loc] is briefly displayed if you try to change parameter values.</p>	

For unlocking:

- ▶ Press [▲] + [▼] simultaneously for 10 s.
- > [uLoc] is displayed.

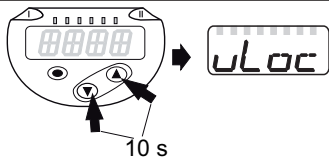

On delivery: not locked.

- Timeout:

If no button is pressed for 30 s during parameter setting, the unit returns to the operating mode with unchanged values.

- Exit parameter without applying the settings

To exit a parameter without applying the settings:

- ▶ Press [▲] + [▼] simultaneously.
- > Return to the menu level.

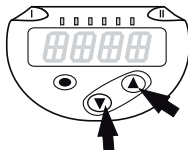



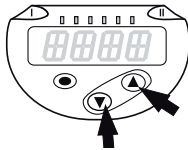

- Exit menu level

To exit the menu level:

- ▶ Press [▲] + [▼] simultaneously.
- > Menu level 2 changes to level 1
or
level 1 changes to the display.





9.2 Define operating mode (optional)

<p>▶ Select [CMPT] and set the required operating mode</p> <ul style="list-style-type: none"> - [1] = operating mode 1 - [2] = operating mode 2 - [3] = operating mode 3 	
<p> Description of the operating modes, see (→ 4.1).</p>	
<p> If IO-Link is used, an IODD that corresponds with the operating mode must be used.</p>	
<p> When the operating mode is changed, all parameters are reset to factory setting.</p>	



UK

9.3 Configure display (optional)

<p>▶ Select [uni] and set the unit of measurement:</p> <ul style="list-style-type: none"> - [bAr], - [MPa], - [PSI] 	
<p>▶ Select [diS] and set the update rate and orientation of the display:</p> <ul style="list-style-type: none"> - [d1]: update of the measured values every 50 ms. - [d2]: update of the measured values every 200 ms. - [d3]: update of the measured values every 600 ms. - [rd1], [rd2], [rd3]: display as with d1, d2, d3; rotated by 180°. - [OFF] = The measured value display is deactivated in the Run mode. The LEDs remain active even if the display is deactivated. Error messages are displayed even if the display is deactivated. 	
<p> Even with unsteady pressure characteristics [d1] provides optimum readability; corresponding algorithms are stored.</p>	

9.4 Set output signals

9.4.1 Set output functions

<p>▶ Select [ou1] and set the switching function:</p> <ul style="list-style-type: none">- [Hno] = hysteresis function / normally open- [Hnc] = hysteresis function / normally closed- [Fno] = window function / normally open- [Fnc] = window function / normally closed- [OFF] = output off. <p> Parameter [OFF] is only available in operating mode 3 ([CMPT] = [3]).</p>	<i>ou 1</i>
<p>▶ Select [ou2] and set the function:</p> <ul style="list-style-type: none">- [Hno] = hysteresis function / normally open- [Hnc] = hysteresis function / normally closed- [Fno] = window function / normally open- [Fnc] = window function / normally closed- [OFF] = output off. <p> Parameter [OFF] is only available in operating mode 3 ([CMPT] = [3]).</p>	<i>ou2</i>

9.4.2 Define switching limits for the hysteresis function

<p>▶ [ou1] / [ou2] must be set as [Hno] or [Hnc].</p> <p>▶ Select [SP1] / [SP2] and set the value at which the output switches.</p>	<i>SP 1</i> <i>SP 2</i>
<p>▶ Select [rP1] / [rP2] and set the value at which the output switches off.</p> <p>rPx is always smaller than SPx. The unit only accepts values which are lower than the value for SPx.</p>	<i>rP 1</i> <i>rP 2</i>

9.4.3 Define switching limits for the window function

<p>▶ [ou1] / [ou2] must be set as [Hno] or [Hnc].</p> <p>▶ Select [FH1] / [FH2] and set the upper limit value.</p>	<i>FH 1</i> <i>FH 2</i>
<p>▶ Select [FL1] / [FL2] and set the lower limit value.</p> <p>FLx is always lower than FHx. The unit only accepts values which are lower than the value for FHx.</p>	<i>FL 1</i> <i>FL 2</i>

9.5 User settings (optional)

9.5.1 Set delay time for the switching outputs

[dS1] / [dS2] = switching delay for OUT1 / OUT2.

[dr1] / [dr2] = reset delay for OUT1 / OUT2.

- ▶ Select [dS1], [dS2], [dr1] or [dr2] and set a value between 0 and 50 s (at 0 the delay time is not active).

dS1
dr1
dS2
dr2

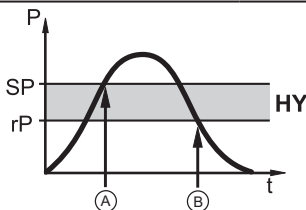

Output function:	A:	B:
[Hno] / [Hnc]	dS	dr

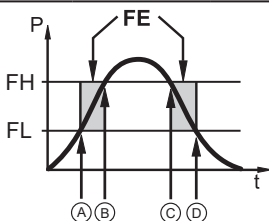

Output function:	A:	B:	C:	D:
[Fno] / [Fnc]	dS	dr	dS	dr

P = system pressure; SP = set point; rP = reset point; HY = hysteresis;
FE = window; FH = upper value; FL = lower value.



If operating mode 1 is used, the delay time will not behave as described here. Refer to the operating instructions of the old device for details: → www.ifm.com



For this unit, the assignment of the parameters [dSx] and [drx] to the set and reset points is strictly designed according to the VDMA guideline.

9.5.2 Set output logic for the switching outputs

▶ Select [P-n] and set [PnP] or [nPn].	<i>P-n</i>
--	------------

9.5.3 Set damping for the switching signal

▶ Select [dAP] and set the damping constant in seconds (τ value: 63 %); setting range 0.000...4.000 s.	<i>dAP</i>
 Damping [dAP] affects the switch point / process data flow (IO-Link communication) and the display.	



9.5.4 Reset all parameters to factory setting

▶ Select [rES]. ▶ Press [•]. ▶ Press [▲] or [▼] and keep pressed until [----] is displayed. ▶ Briefly press [•]. We recommend noting down your own settings before carrying out a reset (→ 12).	<i>rES</i>
 The operating mode [CMPT] will also be reset to the factory setting ([CMPT] = [2]).	

9.5.5 Set colour change of the display

<p>▶ Select [coLr] and set the function:</p> <ul style="list-style-type: none">- [rEd] = display colour red (independent of the measured value).- [GrEn] = display colour green (independent of the measured value).- [r1ou] = display colour red when OUT1 switches.- [G1ou] = display colour green when OUT1 switches.- [r2ou] = display colour red when OUT2 switches.- [G2ou] = display colour green when OUT2 switches.- [r-12] = display colour red when the measured value is between the limits of OUT1 and OUT2.- [G-12] = display colour green when the measured value is between the limits of OUT1 and OUT2.- [r-cF] = display colour is red if the measured value is between the freely definable limits [cFL^{*)} and [cFH^{*)}.- [G-cF] = display colour is red if the measured value is between the freely definable limits [cFL^{*)} and [cFH^{*)}. <p>^{*)} The parameters [cFL] and [cFH] can only be selected in the menu tree if [r-cF] or [G-cF] has been activated.</p>	<i>coLr</i>
<p>▶ Select [cFL] and set the lower limit (only possible if [r-cF] or [G-cF] has been activated).</p> <p>> The setting range corresponds to the measuring range and its maximum limit is [cFH].</p>	<i>cFL</i>
<p>▶ Select [cFH] and set the upper limit (only possible if [r-cF] or [G-cF] has been activated).</p> <p>> The setting range corresponds to the measuring range and its minimum limit is [cFL].</p>	<i>cFH</i>

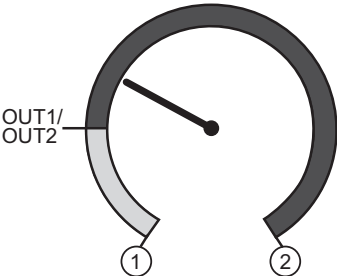
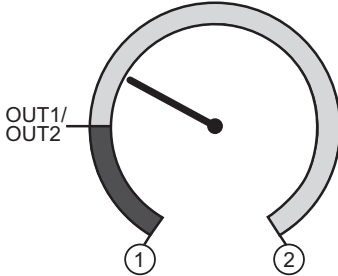
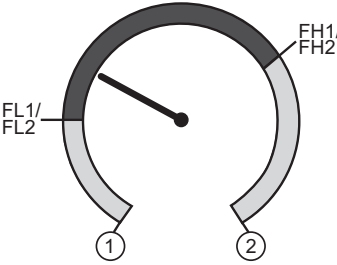
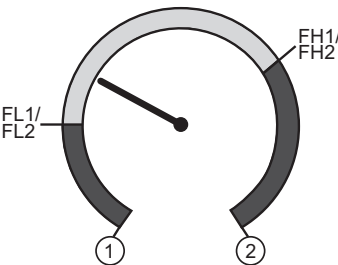
9.5.6 Graphical depiction of the colour change of the display

Display colour change for the parameters [r1ou] / [r2ou] , mode hysteresis function	Display colour change for the parameters [G1ou] / [G2ou] , mode hysteresis function
	
Measured value > switch point OUT1/OUT2 ; display = red	Measured value > switch point OUT1/OUT2 ; display = green
Display colour change for the parameters [r1ou] / [r2ou] , mode window function	Display colour change for the parameters [G1ou] / [G2ou] , mode window function
	
Measured value between FL1/FL2 and FH1/FH2 ; display = red	Measured value between FL1/FL2 and FH1/FH2 ; display = green
	Colour change display green
	Colour change display red
1	Initial value of the measuring range
2	Final value of the measuring range

Display colour change for the parameter [r-12], mode hysteresis function	Display colour change for the parameter [G-12], mode hysteresis function
Measured value between OUT1 and OUT2; display = red	Measured value between OUT1 and OUT2; display = green

Display colour change for the parameter [r-12], mode window function	Display colour change for the parameter [G-12], mode window function
Measured value outside FL1...FH1 and FL2...FH2; display = red	Measured value outside FL1...FH1 and FL2...FH2; display = green

	Colour change display green
	Colour change display red
1	Initial value of the measuring range
2	Final value of the measuring range
FL1/FL2	Lower limit window function outputs OUT1 / OUT2
FH1/FH2	Upper limit window function outputs OUT1 / OUT2

Display colour change with parameter [r-cF] independent of OUT1 / OUT2.	Display colour change with parameter [G-cF] independent of OUT1 / OUT2
Measured value between cFL and cFH; display = red	Measured value between cFL and cFH; display = green

	Colour change display green
	Colour change display red
1	Initial value of the measuring range
2	Final value of the measuring range
cFL	Lower limit (independent of the output function)
cFH	Upper limit (independent of the output function)

9.6 Diagnostic functions

9.6.1 Read min/max values for the system pressure

<ul style="list-style-type: none"> ▶ Select [Hi] or [Lo] and briefly press [●]. [Hi] = maximum value, [Lo] = minimum value. Delete memory: ▶ Select [Hi] or [Lo]. ▶ Press [▲] or [▼] and keep pressed until [----] is displayed. ▶ Briefly press [●]. 	<p>Hi</p> <p>Lo</p>
---	---------------------

9.6.2 Read overload processes

<ul style="list-style-type: none"> • HIPC: Number of overload processes HIPC counts how often the limit HIPS has been exceeded. The limit must be exceeded for at least 0.5 ms. • HIPS: Setting of the threshold for the overload counter. 	HIPC HIPS
 The parameters HIPC and HIPS are only available via IO-Link communication.	

10 Operation

UK

After power on, the unit is in the Run mode (= normal operating mode). It carries out its measurement and evaluation functions and provides output signals according to the set parameters.

Operation indication (→ 7 Operating and display elements).

10.1 Read set parameters

- ▶ Press [●].
- ▶ Press [▲] or [▼] until the required parameter is displayed.
- ▶ Briefly press [●].
- > The unit displays the corresponding parameter value for approx. 30 s; then it changes to the process value display.

10.2 Self-diagnostics / fault indications

The unit has many self-diagnostic options.

- It monitors itself automatically during operation.
- Warnings and faults are displayed (even if the display is deactivated), in addition they are available via IO-Link.

Display	Status LED OUT1	Status LED OUT2	Type of fault *)	Fault / warning	Corrective measures
none			F	Supply voltage too low.	▶ Check / correct the supply voltage.
SC flashes	flashes	flashes	F	Excessive current on switching outputs OUT1 and OUT2 **).	▶ Check switching outputs for short circuit or excessive current; remove the fault.

Display	Status LED OUT1	Status LED OUT2	Type of fault *)	Fault / warning	Corrective measures
SC1 flashes	flashes		F	Excessive current at switching output OUT1 **).	► Check switching output OUT1 for short-circuit or excessive current; remove the fault.
SC2 flashes		flashes	F	Excessive current at switching output OUT2 **).	► Check switching output OUT2 for short-circuit or excessive current; remove the fault.
Loc			W	Parameter setting locked via buttons.	► Unlock buttons (→ 9.1 Parameter setting in general) → "Locking / unlocking".
C.Loc			W	Parameter setting locked via pushbuttons, parameter setting is enabled via IO-Link communication (→ 9.1).	► Wait until parameter setting via IO-Link is finished.
S.Loc			W	Setting buttons locked via parameter setting software. Parameter change is rejected (→ 9.1).	► Unlocking only possible via IO-Link interface / parameter setting software.
OL			W	Process value too high (measuring range exceeded).	► Check / reduce system pressure / select unit with corresponding measuring range.
UL			W	Process value too low (value below measuring range).	► Check / increase system pressure / select unit with corresponding measuring range.
Err flashes			F	Internal fault / malfunction.	► Contact the manufacturer.

*) F = fault

W = warning

**) The output remains deactivated as long as the excessive current / short circuit continues.

11 Technical data

11.1 Setting ranges



The setting ranges depend on the operating mode (→ 4.1).

11.1.1 Setting ranges in operating mode 2

		rP / SP		cFL / cFH		ΔP
		Setting range	Min. distance	Setting range	Min. distance	
PN7072 PN7572	bar	0.5...100	0.5	0...100	0.5	0.5
	psi	5...1450	10	0...1450	10	5
	MPa	0.05...10	0.05	0...10	0.05	0.05

ΔP = step increment

11.1.2 Setting ranges in operating mode 3

		rP / SP		cFL / cFH		ΔP
		Setting range	Min. distance	Setting range	Min. distance	
PN7072 PN7572	bar	0.3...100	0.5	0...100	0.5	0.1
	psi	5...1450	8	0...1450	8	1
	MPa	0.03...10	0.05	0...10	0.05	0.01

ΔP = step increment

11.2 Further technical data



Further technical data and scale drawing at: www.ifm.com.

12 Factory setting

	Factory setting	User setting
SP1	25% VMR *	
rP1	23% VMR *	
OU1	Hno	
OU2	Hno	
SP2	75% VMR *	
rP2	73% VMR *	
dS1	0.0	
dr1	0.0	
dS2	0.0	
dr2	0.0	
P-n	PnP	
dAP	0.06	
Uni	bAr	
colr	rEd	
diS	d2	
cFH	VMR	
cFL	MAW	
HIPS**	VMR	
CMPT	2	

VMR Final value of the measuring range.

MAW Initial value of the measuring range.

* = The indicated percentage of the final value of the measuring range (VMR) of the corresponding sensor is set in bar.

** = HIPS is only available via IO-Link communication

