



Operating instructions  
Cylinder sensor with IO-Link  
**MK59xx**

**GB**

11463922 / 00 12 / 2022



## Contents

1	Preliminary note	3
1.1	Symbols used	3
2	Safety instructions	4
3	Items supplied	5
4	Intended use	6
4.1	Application area	6
4.2	Restriction of the application area	6
5	Function	7
5.1	Measuring principle	7
5.2	Signal range	7
5.3	Switching signal	8
5.4	Application examples for position monitoring	9
5.4.1	End position with setting aid	9
5.4.2	Detecting two end positions (short-stroke cylinder)	9
5.4.3	Position detection	10
5.4.4	Inline material detection	10
5.5	IO-Link	11
6	Installation	12
6.1	Geometric alignment	12
7	Electrical connection	13
8	Operating and display elements	14
9	Parameter setting	15
9.1	Setting switch points	15
9.2	Teach functions	16
9.2.1	Switch point teach	16
9.2.2	Section Teach	17
9.2.3	Teach In Application	18
9.3	Switch point logic	19
9.4	Switching delay	19
9.5	Signal direction	19
9.6	Output polarity of the switching outputs	20
9.7	Output off	20
9.8	Diagnostics	21
9.8.1	Stroke time monitoring	21
9.8.2	Switching cycle monitoring	23
9.8.3	Magnetic field monitoring	24
9.8.4	Operating hours counter	24
9.8.5	Power cycles	24
9.8.6	Internal temperature	24
9.9	Parameter setting examples	25
9.9.1	Detecting two end positions (short-stroke cylinder)	25
9.9.2	Inline material detection	26
9.9.3	Soiling indication	27
9.10	Resetting the device	28
9.11	Identification	29
9.11.1	Device information	29
9.11.2	Optical localisation	29
10	Operation	30
11	Troubleshooting	31
12	Maintenance, repair and disposal	32
13	Factory settings	33

# 1 Preliminary note

You will find instructions, technical data, approvals, accessories and further information using the QR code on the unit / packaging or at [www.ifm.com](http://www.ifm.com).

## 1.1 Symbols used

- ✓ Requirement
- ▶ Instructions
- ▷ Reaction, result
- [...] Designation of keys, buttons or indications
- Cross-reference
-  Important note  
Non-compliance may result in malfunction or interference.
-  Information  
Supplementary note

## 2 Safety instructions

- The unit described is a subcomponent for integration into a system.
  - The system architect is responsible for the safety of the system.
  - The system architect undertakes to perform a risk assessment and to create documentation in accordance with legal and normative requirements to be provided to the operator and user of the system. This documentation must contain all necessary information and safety instructions for the operator, the user and, if applicable, for any service personnel authorised by the architect of the system.
- Read this document before setting up the product and keep it during the entire service life.
- The product must be suitable for the corresponding applications and environmental conditions without any restrictions.
- Only use the product for its intended purpose (→ Intended use).
- If the operating instructions or the technical data are not adhered to, personal injury and/or damage to property may occur.
- The manufacturer assumes no liability or warranty for any consequences caused by tampering with the product or incorrect use by the operator.
- Installation, electrical connection, set-up, operation and maintenance of the product must be carried out by qualified personnel authorised by the machine operator.
- Protect units and cables against damage.

### 3 Items supplied

- Cylinder sensor
- Cable clip
- Rubber placeholder



The following are additionally required for installation: hexagon socket 1.5 mm or slotted screwdriver (not included).

## 4 Intended use

The device continuously monitors the position of a permanent magnet without contact.

The permanent magnet is detected through non-ferromagnetic cylinder housings.

### 4.1 Application area

The device is used to detect the position of the piston in pneumatic cylinders.

The device detects the ring magnet attached to a piston through a housing wall of non-magnetisable material (aluminium, brass or stainless steel).

Special adapters for mounting on the following cylinder profiles are available as accessories:

- Clean line and tie rod cylinders
- Integrated profile cylinder
- Trapezoidal slot cylinder

### 4.2 Restriction of the application area

The device is not approved for use in potentially explosive atmospheres.

Incorrect measurements may be caused by the following environmental conditions:

- Ferromagnetic environment (elements made of iron)
  - Alternating electromagnetic fields
  - Rotation of magnets can lead to fluctuations in field strength.
- Check the correct function by performing an application test.

## 5 Function

The device provides the following functions and signals them with a switching signal:

- monitoring the piston position in pneumatic cylinders.
- diagnostic functions:
  - [Stroke time monitoring](#) (→ [21](#))
  - [Switching cycle monitoring](#) (→ [23](#))
  - [Magnetic field monitoring](#) (→ [24](#))

Depending on the device type, one or two physical switching outputs are available:

T-slot sensors	Number of switching outputs
MK5904, MK5907, MK5908, MK5909	2
MK5905, MK5906	1

### 5.1 Measuring principle

The device measures the magnetic field in 2 spatial directions ( $B_x$  and  $B_y$ ) and calculates the absolute magnetic field ( $B_{abs}$ ) and a position-dependent signal [PDV1].

The absolute magnetic field must be in the range of 1 mT...20 mT.

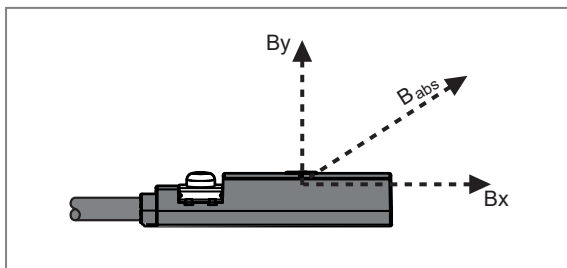

$B_x$ : Magnetic field in x-direction  
 $B_y$ : Magnetic field in y-direction  
 $B_{abs}$ : Absolute magnetic field

If the magnetic system is designed accordingly, the calculated output signal is linear and proportional to the position of an encoder magnet.

**!** Ferromagnetic materials (iron), permanent magnets and magnetic fields in the vicinity of the device or the encoder magnet can influence and falsify the signal.

### 5.2 Signal range

The device provides a measured value [PDV1] depending on the position of the encoder magnet in the range of 0...4000. This value is dimensionless, but proportional to the position of the encoder magnet.

The output signal corresponds to the value 2000 when the encoder magnet is centred under the target marking "T" on the sensor. Due to the shape of the encoder magnet and the distance between the device and the magnet, different slopes of the signal curve as well as different resolutions and measuring ranges can be achieved.

**i** The longer a magnet is, the lower the slope of the signal curve and the resolution and the larger the measuring range becomes.

**!** If the magnets are too weak or the distance between the device and the magnet is too great, the signal range may be limited at the edges if the magnetic field is too weak.

**!** If the magnets are too strong or the distance between the device and the magnet is too small, the signal range may be interrupted in the middle if the magnetic field is too strong.

### 5.3 Switching signal

The device has 2 switching signal channels SSC1.1 and SSC1.2. Each switching signal channel has a parameter set with which the switching behaviour can be adjusted.

Using the parameter setting software, the switching signal channels can be freely assigned to one of the outputs OUT1 or OUT2.



For devices that have only one output, the switching signal channels SSC1.1 and SSC1.2 can only be assigned to OUT1.

The switch points and the switch point logic are set when the switching signal channel parameters are set. If the process data value (PDV) exceeds a switch point, the hardware output changes its switching state (active or inactive). Depending on the setting of the switch point logic, the output is in the active switching state [High active] or [Low active]:

- [High active]: Output in active state closed/ON (normally open/NO).
- [Low active]: Output in active state open/OFF (normally closed/NC).

You can choose between the following switch point modes according to the IO-Link smart sensor profile - Function Class "Object Detection" - : [Deactivated], [Single Point], [Window], [Two Point].

#### Deactivated

If the [Deactivated] mode is set for a switching signal channel, the assigned hardware output will not change its switching state depending on the process data value, but permanently assumes the inactive state: If the deactivated switching signal channel is set to [High active], it is permanently "low", if it is set to [Low active], it is permanently "high".

#### Single-point mode

Only one switch point (SP1) is manually set or taught. The switch-off point results from the switch point and the set hysteresis (H).

The switch point SP2 will be ignored in Single Point Mode.

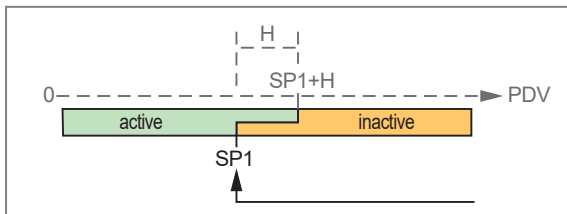

Fig. 1: Single-point mode

#### Two-point mode

A switch point and a reset point are manually set or taught.

It is possible to configure which of the two switch points is the larger one. The larger switch point is the reset point. In the example shown, SP2 is the switch point and SP1 is the reset point.

The hysteresis will be ignored in Two Point Mode.

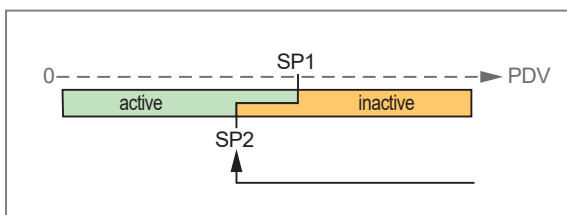

Fig. 2: TwoPoint Mode



## Window mode

Two switch points (SP1) and (SP2) are manually set or taught. The two switch points delimit a window area.

Switching back takes place when the hysteresis is exceeded after leaving the window area.

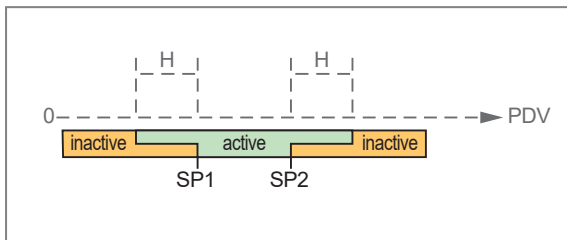
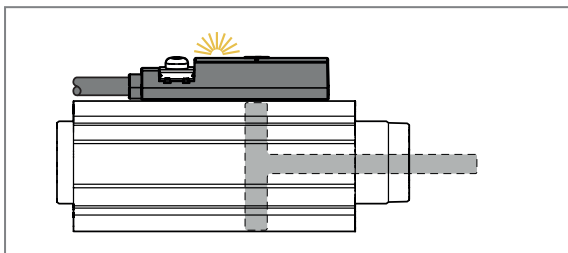

Fig. 3: Window mode

## 5.4 Application examples for position monitoring

### 5.4.1 End position with setting aid

The setting aid can be used to shut down a device or valve prematurely so that the cylinder moves more smoothly into the end stop.



Cylinder shortly before the end position (e.g. at 80 % of the end position):

LED 1 is on. The output to which SSC1.1 has been assigned switches.

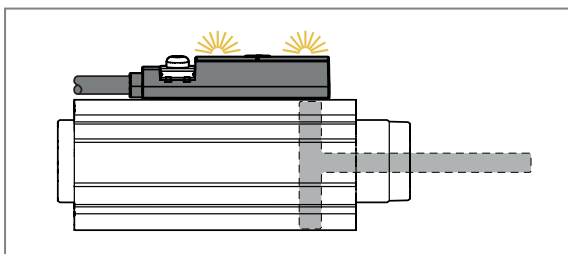

Cylinder in the end position:

Both LEDs are on, both outputs switch.

### 5.4.2 Detecting two end positions (short-stroke cylinder)

If the stroke of the cylinder does not exceed the measuring range of the device, both end positions can be displayed with one device.

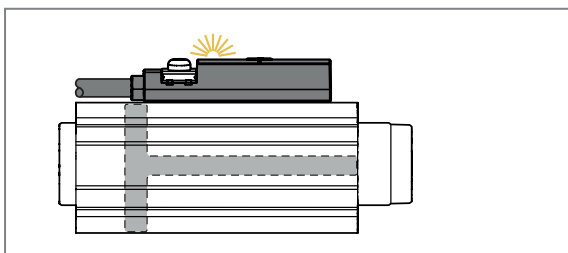

Cylinder in end position 1:

LED 1 is on. The output to which SSC1.1 has been assigned switches.

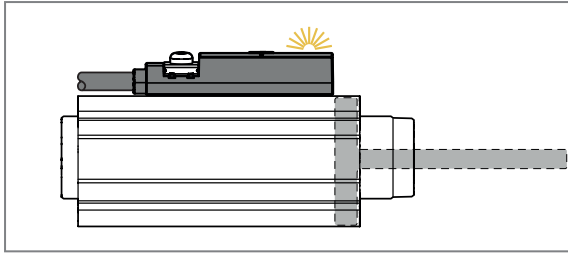

Cylinder in end position 2:

LED 2 is on. The output to which SSC1.2 has been assigned switches.



See also application example (→ [Detecting two end positions \(short-stroke cylinder\)](#) □ 25).

### 5.4.3 Position detection

When using the IO-Link interface, the magnet position can be evaluated exactly via a dimensionless process data value between 0...4000. The process data value is linearly proportional to the magnet position.

Thanks to accurate position detection, process deviations can be monitored, such as the drift of an operation as well as wear and soiling. In this way, quality monitoring can be carried out independently of switch points by the PLC.

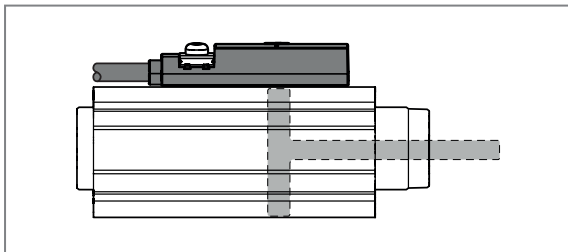

Cylinder between the end positions.

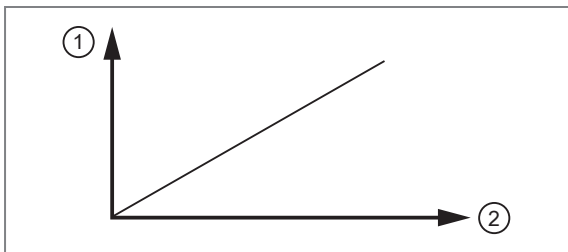

Accurate position detection through continuous measurement.

1: Process data value [PDV1]

2: Magnet position

### 5.4.4 Inline material detection

With inline material detection, objects can be recognised, compared and counted. This can be done using accurate position detection via IO-Link or the physical switching outputs and the LED display.

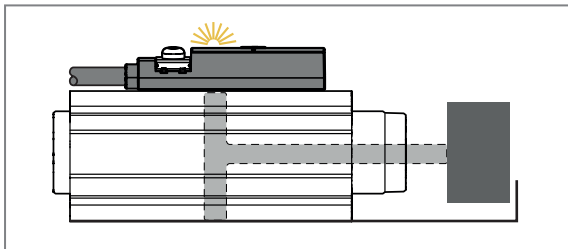

Cylinder detects predefined object.

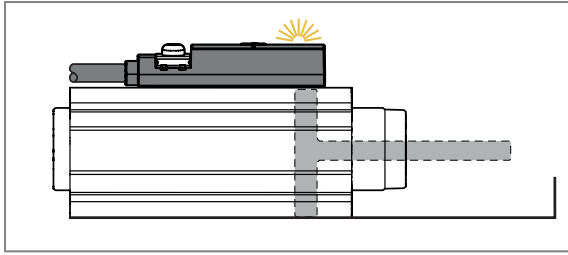

Cylinder detects no object.



See also application example (→ [Inline material detection](#) 26).

## 5.5 IO-Link

IO-Link is a communication system for connecting intelligent sensors and actuators to automation systems. IO-Link is standardised in the IEC 61131-9 standard.



General information on IO-Link at [io-link.ifm](http://io-link.ifm)



Input Output Device Description (IODD) with all parameters, process data and detailed descriptions of the device at [documentation.ifm.com](http://documentation.ifm.com)

IO-Link offers the following advantages:

- Interference-free transmission of all data and process values
- Parameter setting in the running process or presetting outside the application
- Parameters for identifying the connected devices in the system
- Additional parameters and diagnostic functions
- Automatic backup and restore of parameter sets in case of device replacement (data storage)
- Logging of parameter sets, process values and events
- Device description file (IODD - Input Output Device Description) for easy project planning
- Standardised electrical connection
- Remote maintenance

## 6 Installation

To simplify installation, the two switching signal channels are set to [Window Mode] when delivered: The larger window area of SSC1.1 indicates the entire switching range with LED1, the smaller window area of SSC1.2 indicates the middle of the switching range with LED2.

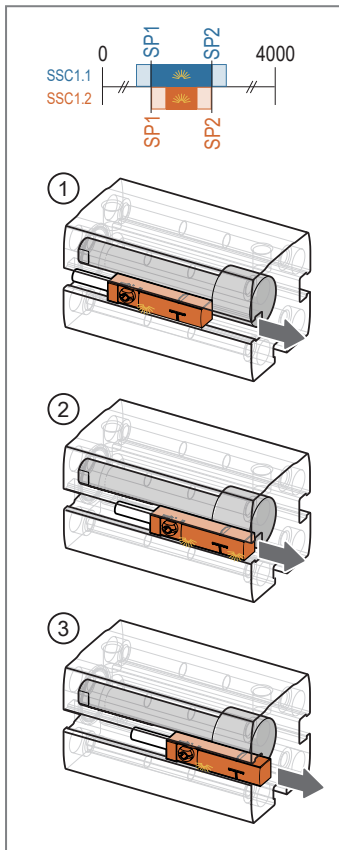

Fig. 4: Installation with factory setting

- ▶ Insert the device into the groove in the middle of the cylinder.
- ▶ Push the device in the groove in the direction of the end position that is to be detected.
- ▷ LED1 goes on when the switch point SSC1.1 SP1 is reached (1).
- ▶ Push the device further towards the end position.
- ▷ LED2 goes on when the switch point SSC1.2 SP1 is reached. When both LEDs are on, this indicates the middle of the switching area (2).
- ▶ Fix the device in this position using the fastening clamp if the end position is to be roughly detected.

If the end position is to be detected as precisely as possible:

- ▶ Push the device further towards the end position until LED2 goes out (3).
- ▶ Fix the device in this position using the fastening clamp.

### 6.1 Geometric alignment

The magnetic axis of the encoder magnet should be parallel to the longitudinal axis of the device and correspond to the direction of movement.

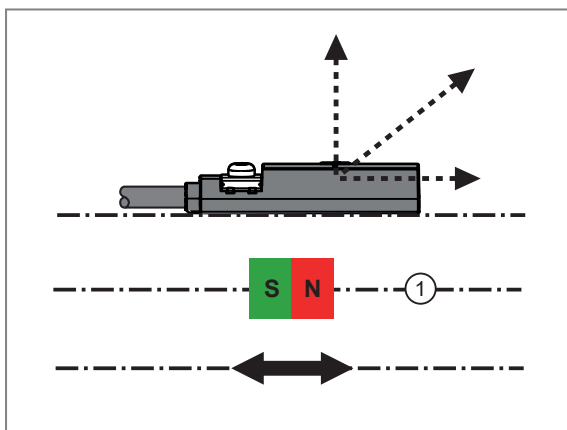

1: Magnetic axis



In the event of magnetisation errors (magnetic axis not parallel to the device) or an offset between the magnetic axis and the sensor plane, the linearity of the output signal [PDV1] will be impaired.

## 7 Electrical connection



The unit must be connected by a qualified electrician.

Observe the national and international regulations for the installation of electrical equipment.

Voltage supply according to SELV, PELV.

► Disconnect power.

► Connect the unit as follows:

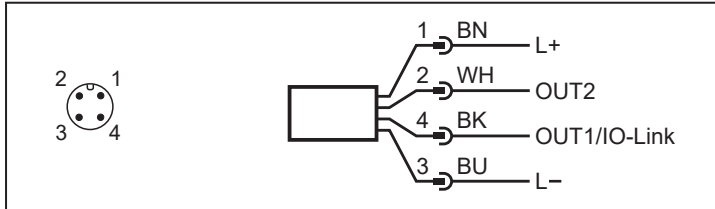

Fig. 5: Wiring diagram (colours to DIN EN 60947-5-2)

BK: black  
BU: blue

BN: brown  
WH: white

Pin	Connection
1	L+
3	L-
4 (OUT1)	switching output or IO-Link
2 (OUT2)	switching output (depending on device type (→ <a href="#">Function 7</a> ))

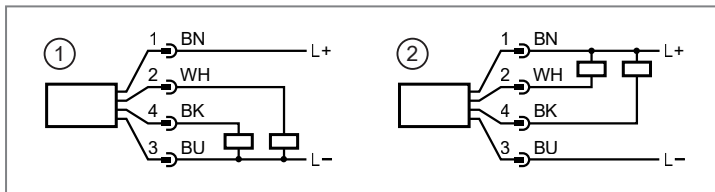
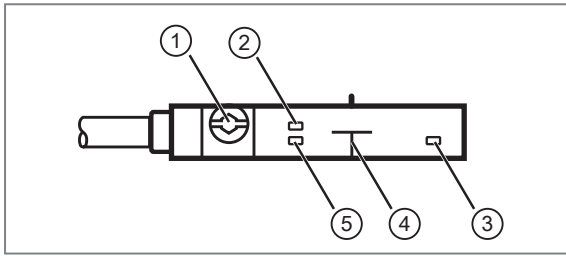

Fig. 6: Circuit examples

1: 2 x pnp

2: 2 x npn

## 8 Operating and display elements



- 1: Fastening clamp
- 2: LED green (ready for operation)
- 3: LED2 yellow (switching signal channel SSC1.2)
- 4: Sensing face
- 5: LED1 yellow (switching signal channel SSC1.1)

The two LEDs are permanently assigned to the switching signal channels: LED1 to SSC1.1 and LED2 to SSC1.2.

If the switching status LEDs are yellow, this signals the active status of the switching signal channel.

- If the switching signal channel is set to the switch point logic [High active], the LED goes on when the output is closed.
- If the switching signal channel is set to the switch point logic [Low active], the LED goes on when the output is open.



The two yellow switching status LEDs can be set to synchronous double flashing with the command [Locator] in order to be able to identify the device in the installation (→ [Optical localisation](#)  29).



In the event of a short circuit or hardware error in the device, both yellow switching status LEDs will flash until the error is eliminated (→ [Troubleshooting](#)  31).

## 9 Parameter setting

The parameters are set via the IO-Link interface on pin 4 using the parameter setting software.

Parameters can be set before installation or during operation.



If you change parameters during operation, this will influence the function of the plant.

- ▶ Ensure that there will be no malfunctions in your plant.

During parameter setting the unit remains in the operating mode. It continues to monitor with the existing parameter until the parameter setting has been completed.

Requirements for parameter setting via the IO-Link interface:

- ✓ A suitable parameter setting software, e.g. ifm moneo|configure
- ✓ The Input Output Device Description (IODD) for the device, see [documentation.ifm.com](https://documentation.ifm.com)
- ✓ One IO-Link master
- ▶ Connect the IO-Link master to a parameter setting software.
- ▶ Set the port of the master to the IO-Link operating mode.
- ▶ Connect the device to a free port of the IO-Link master.
- ▷ The unit switches to IO-Link mode.
- ▶ Change parameter settings in the software.
- ▶ Write parameter settings to the unit.



Notes on parameter setting → Manual of the parameter setting software



When the pneumatic cylinder is changed, it may also be necessary to adapt the device settings.

### 9.1 Setting switch points

- ▶ Select [Parameter] > [Output configuration] > [oux] and set the switching signal channel for output OUTx: [SSC1.1] or [SSC1.2].
- ▶ Select [Parameter] > [SSC1.x].

#### Single point mode:

- ▶ [SSC1.x Config. ]Select [Mode] and set the switch point mode: [Single Point].
- ▶ [SSC1.x Param. ]Select [SP1] and set switch point 1.
- ▶ [SSC1.x Config. ]Select [Hyst] and set the hysteresis.

#### Two-point mode:

- ▶ [SSC1.x Config. ]Select [Mode] and set the switch point mode: [Two Point].
- ▶ [SSC1.x Param. ]Select [SP1] and set switch point 1.
- ▶ [SSC1.x Param. ]Select [SP2] and set switch point 2.

#### Window mode:

- ▶ [SSC1.x Config. ]Select [Mode] and set the switch point mode: [Window].
- ▶ [SSC1.x Param. ]Select [SP1] and set switch point 1.
- ▶ [SSC1.x Param. ]Select [SP2] and set switch point 2.
- ▶ [SSC1.x Config. ]Select [Hyst] and set the hysteresis.



The switch points SP1 and SP2 must have a minimum distance to the limits of the measuring range (0 and 4000) in the size of the hysteresis. This restriction applies to each mode, so that it is possible to switch between the switch point modes.



If the hysteresis is set to 0, the device adopts the [Auto] setting. This setting corresponds to a hysteresis value of 100.

## 9.2 Teach functions

The three teach functions can be used to teach switch points for the switching signal channels SSC1.1 and SSC1.2 based on the current magnet position.

The application teach-in also allows automatic parameter setting of the stroke time monitoring ([→ Stroke time monitoring parameter setting](#) [□ 21](#)).

### 9.2.1 Switch point teach

In case of the switch point teach [Teach SPx], the switch points are taught individually for the selected switch channel SSC1.x on the basis of the current magnet position. The switch point mode can be freely selected.

In [Single Point] mode, the current measured value plus the set hysteresis is adopted as switch point SP1, so that the switch point has a reserve when the cylinder is fully in the end position:

- $SP1 = \text{current measured value} + \text{hysteresis}$

In the [Window] mode and in the [Two Point] mode, the switch point SPx is set exactly to the current measured value:

- $SP1 = \text{current measured value at end position 1}$
- $SP2 = \text{current measured value at end position 2}$



A switch point teach can also be carried out by means of manual configuration ([→ Setting switch points](#) [□ 15](#)).

#### Parameter setting:

- ▶ Install the device in the groove.
- ▶ Select [Parameter] > [Output configuration] > [oux] and set the switching signal channel [SSC1.x].
- ▶ Select [Parameter] > [SSC1.x].

#### Single point mode:

- ▶ [SSC1.x Config. ]Select [Mode] and set the switch point mode: [Single Point].
- ▶ Move the cylinder to the required end position 1.
- ✓ Check that the current measured value is within the limits of the measuring range.
- ▶ Select [Parameter] > [Teach].
- ▶ Select [TI Select] and set the switching signal channel [SSC1.x].
  - ▷ The following teach will be executed for the selected switching signal channel.



If [TI Select] = [all SSC] is selected, the teach is carried out for both switching signal channels simultaneously.

- ▶ Execute command: [Teach SP1].
  - ▷ [TI Result. State] shows the status of the teach process.
- ▷ The switch point SP1 is set for the selected switching signal channel.

#### Window and Two Point Mode:

- ▶ [SSC1.x Config. ]Select [Mode] and set the switch point mode: [Window] or [Two Point].



- ▶ Move the cylinder to the required end position 1.
- ✓ Check that the current measured value is within the limits of the measuring range.
- ▶ Select [Parameter] > [Teach].
- ▶ Select [TI Select] and set the switching signal channel [SSC1.x].
  - ▷ The following teach will be executed for the selected switching signal channel.



If [TI Select] = [all SSC] is selected, the switch point teach will be carried out for both switching signal channels simultaneously.

- ▶ Execute command: [Teach SP1].
  - ▷ [TI Result. State] shows the status of the teach process.
- ▶ Move the cylinder to the required end position 2.
- ✓ Check that the current measured value is within the limits of the measuring range.
- ▶ Execute command: [Teach SP2].
  - ▷ [TI Result. State] shows the status of the teach process.
- ▷ The switch points SP1 and SP2 are set for the selected switching signal channel.

## 9.2.2 Section Teach

During [Section Teach], both switch points for the selected switching signal channel SSC1.x are taught using the current magnet position in an end position and the switch point mode is automatically set to [Window].

The switch points SP1 and SP2 are calculated with the current measured value and the set hysteresis:

- $SP1 = \text{current measured value} - \text{hysteresis}$
- $SP2 = \text{current measured value} + \text{hysteresis}$

### Parameter setting:

- ▶ Install the device in the groove.
- ▶ Select [Parameter] > [Output configuration] > [oux] and set the switching signal channel [SSC1.x].
- ▶ Move the cylinder to the required end position.
- ✓ Check that the current measured value is within the limits of the measuring range.
- ▶ Select [Parameter] > [Teach].
- ▶ Select [TI Select] and set the switching signal channel [SSC1.x].
  - ▷ The following teach will be executed for the selected switching signal channel.



If [TI Select] = [all SSC] is selected, the teach is carried out for both switching signal channels simultaneously.

- ▶ Select [Parameter] > [SSC1.x] > [SSC1.x Config. Hyst] and set the hysteresis.
- ▶ Select [Parameter] > [Teach] > [Teach Custom].
- ▶ Execute command: [Section Teach].
  - ▷ [TI Result. State] shows the status of the teach process.
- ▷ The switch points SP1 and SP2 are set for the selected switching signal channel, the switch point mode is [Window].

### 9.2.3 Teach In Application

During [Teach In Application], the switch point SP1 is automatically determined for the selected switching signal channel SSC1.x: After moving the magnet back and forth three times, the sensor detects the minimum and maximum measured value and thereby interprets the two end positions. The switch point mode is automatically set to [Single Point] and the following settings are made:

- When teaching SSC1.1:
  - [SSC1.1 SP1] = minimum measured value + hysteresis SSC1.1
  - [SSC1.1 Config. Mode] = [High active]
  - [ou1] = [SSC1.1]
  - [Reference actuator runtime] and [tolerance actuator running time], see [Stroke time monitoring parameter setting](#) (→ [21](#)).
- When teaching SSC1.2:
  - [SSC1.2 SP1] = maximum measured value – 2x hysteresis SSC1.2
  - [SSC1.2 Config. Mode] = [Low active]
  - [ou2] = [SSC1.2]
  - [Reference actuator runtime] and [Tolerance actuator runtime], see [Stroke time monitoring parameter setting](#) (→ [21](#)).



The minimum measured value and the maximum measured value must be at least twice the value of hysteresis SSC1.1 and hysteresis SSC1.2 apart:  
 $PDV_{max} - PDV_{min} \geq (2x [SSC1.1 \text{ Config. Hyst}] + 2x [SSC1.2 \text{ Config. Hyst}])$ .

#### Parameter setting:

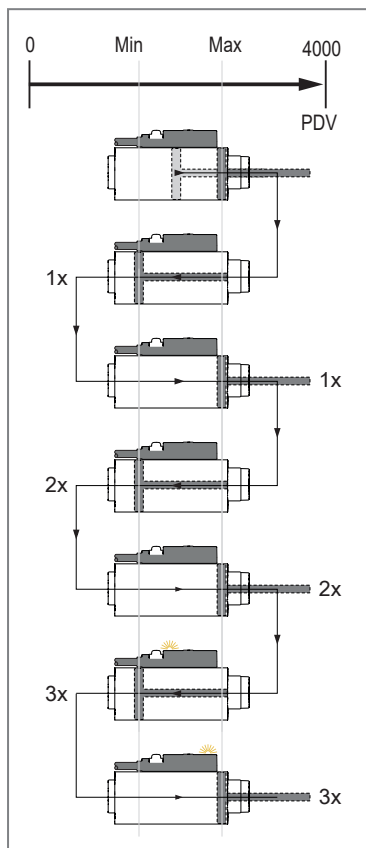

Fig. 7: Example [all SSC]: LEDs signal both end positions

- ▶ Install the device in the groove.
- ✓ Check that the current travel range of the cylinder is within the limits of the measuring range.
- ▶ Select [Parameter] > [Teach] > [Teach Single Value].
- ▶ Select [TI Select] and set the switching signal channel [SSC1.x].
  - ▷ The following teach will be executed for the selected switching signal channel.
- If [TI Select] = [all SSC] is selected, the teach is carried out for both switching signal channels simultaneously.
- ▶ Select [Parameter] > [SSC1.x] > [SSC1.x Config. Hyst] and set the hysteresis.
- ▶ Select [Parameter] > [Teach] > [Teach Custom].
- ▶ Execute command: [Teach In Application].
- ▶ Move the cylinder back and forth between the end positions (min/max). The end positions must be reached alternately three times each.
  - ▷ [TI Result. State] shows the status of the teach process.
- ▷ The switch point SP1 is set for the selected switching signal channel, the switch point mode is [Single Point] and other parameters are set automatically (see above).



If SSC1.1 is taught, only the minimum end position will be monitored.  
 If SSC1.2 is taught, only the maximum end position will be monitored.  
 If both switching signal channels are taught, both end positions will be monitored by opposite switching behaviour and the display of both LEDs.



If the LEDs do not match the position of the cylinder after teaching, the signal direction must be inverted before teaching (→ [Signal direction](#) 19).



To increase the switching zones for the end positions, there are the following possibilities:

- ▶ Increase the hysteresis before teaching or manually shift the switch points after teaching (→ [Setting switch points](#) 15). In both cases, the automatically set times [Reference actuator runtime] and [Tolerance actuator runtime] are no longer correct and must be re-configured. See [Stroke time monitoring parameter setting](#) (→ 21).

### 9.3 Switch point logic

The switch point logic of the switching outputs can be set.

Selectable values:

- [High active] = normally open
- [Low active] = normally closed
- ▶ Select [Parameter] > [SSC1.x].
- ▶ Select [SSC1.x Config. Logic] and set the switch point logic for the switching signal channel SSC1.x.

### 9.4 Switching delay

For both switching signal channels, a separate delay time can be set for the output to switch and to be reset.

A switching delay can be useful in the following cases:

- The switch-on and switch-off delay can be used as a filter, for example, to block out magnetic interference fields caused by short-time high currents.
- The switch-off delay can be used as a signal extension.
- With a switch-on delay, a signal can be faded out if the corresponding area is only passed over. The signal will only be output when the application comes to a standstill in the corresponding area or after a corresponding time.



Use in welding applications:  
 To suppress interference from high AC welding currents, the switch-on and switch-off delay must be set to a value greater than 20 ms.

#### Parameter setting:

- ▶ Select [Parameter] > [SSC1.x].
- ▶ Select [SSC1.x Switch-On delay] and set the time for the switch-on delay.
- ▶ Select [SSC1.x Switch-Off delay] and set the time for the switch-off delay.

### 9.5 Signal direction

Depending on the orientation of the magnet, the slope of the signal may vary.

With the following signal, the sensor behaves according to Function Class "Object Detection":

- The process data value (PDV) becomes smaller as the target approaches the sensor.

- The process data value (PDV) increases as the target moves away from the sensor.



- ▶ Set the signal direction so that the sensor behaves according to the specified function class "Object Detection".

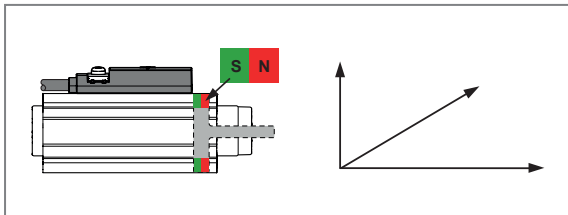

Fig. 8: Cylinder rod North Pole direction

The signal increases when the cylinder rod is extended.

The sensor behaves according to the specified function class "Object Detection".

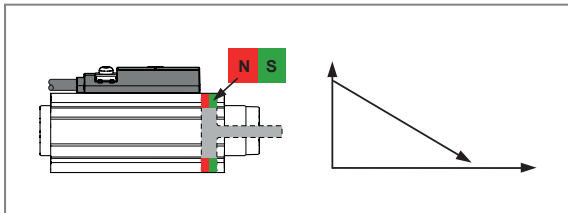

Fig. 9: Cylinder rod South Pole direction

The signal decreases when the cylinder rod is extended.

- ▶ Inverting the signal direction.

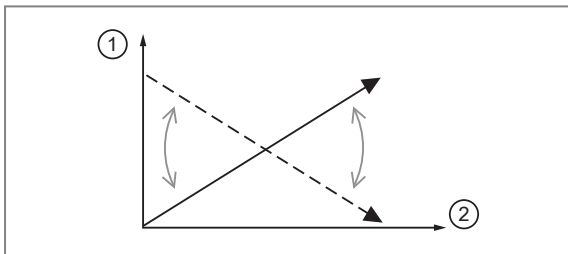

Fig. 10: Signal inversion

1: PDV  
2: Magnet position



After a [Teach In Application], the LEDs for the switch point display may be inverted. By inverting the signal direction before a [Teach In Application], the assignment of the LEDs can also be changed.

### Parameter setting:

- ▶ Select [Parameter] > [Signal] > [Signal direction] to set the signal direction.

## 9.6 Output polarity of the switching outputs

The parameter [P-n] can be used to select whether the outputs are plus-switching or negative-switching.

- ▶ Select [Parameters] > [Setup].
- ▶ Select [P-n] and set [PnP] or [nPn].

## 9.7 Output off

The output signal for output OUT1 or output OUT2 can be switched off in two ways:

- [OFF]: The physical output OUTx becomes highly resistive so that no signal can be output. The status of the switching signal channels SSC1.x is still transmitted via the IO-Link interface.
  - [Deactivated]: The switching signal channel is deactivated, i.e. the switching state is permanently in the inactive state: With [High active] setting permanently "low", with [Low active] setting permanently "high".
- ▶ Call up [Parameters] > [Output Configuration].
  - ▶ Select [oux] and set [OFF].

- or -

- ▶ Select [Parameter] > [SSC1.x].
- ▶ [SSC1.x Config. ]Select [Mode] and set [Deactivated].

## 9.8 Diagnostics

The device provides the following diagnostic information via the IO-Link interface:

- [Operating hours counter](#) (→ [24](#))
- [Power cycles](#) (→ [24](#))
- [Internal temperature](#) (→ [24](#))
- [Stroke time monitoring](#) (→ [21](#))
- [Switching cycle monitoring](#) (→ [23](#))
- [Magnetic field monitoring](#) (→ [24](#))

In addition, diagnostic messages can be output as switching signals via the hardware outputs OUT1 and OUT2. The switching output set for the diagnostic message is switched on in normal operation (normally closed). If the device detects a diagnostic case, the output will be switched off. The switch point logic cannot be changed.

Diagnostic cases are:

- Timeout 1 → 2 (→ [Stroke time monitoring](#) [21](#)):  
The tolerated time window between the activation of SSC1.1 and the activation of SSC1.2 has been exceeded or not reached.
- Timeout 2 → 1 (→ [Stroke time monitoring](#) [21](#)):  
The tolerated time window between the activation of SSC1.2 and the activation of SSC1.1 has been exceeded or not reached.
- Overflow SCT1.1 (→ [Switching cycle monitoring](#) [23](#)):  
The threshold value for the switching cycles counter SCT1.1 has been reached.
- Overflow SCT1.2 (→ [Switching cycle monitoring](#) [23](#)):  
The threshold value for the switching cycles counter SCT1.2 has been reached.
- NoData (→ [Magnetic field monitoring](#) [24](#)):  
The magnetic field is too strong or too weak or the magnet is outside the measuring range.

### 9.8.1 Stroke time monitoring

The stroke time monitoring function monitors the time required by the lifting cylinder to change between two end positions. The two positions (end position 1 and end position 2) are each signalled by a switching signal via the switching signal channels SSC1.1 and SSC1.2.

If more or less time is needed for the position change than set via a tolerance time, the "Timeout" event will be activated.

Stroke time monitoring can be used, for example, to detect wear on the cylinder, dirt in the application or low air pressure.

#### 9.8.1.1 Stroke time monitoring parameter setting

The time for changing a piston rod between two end positions can be monitored in both directions of movement of the lifting cylinder. For this purpose, the sequence of the switching process must be observed when selecting the parameters:

- 1 --> 2 : Time between deactivation of SSC1.1 and activation of SSC1.2
- 2 --> 1 : Time between deactivation of SSC1.2 and activation of SSC1.1

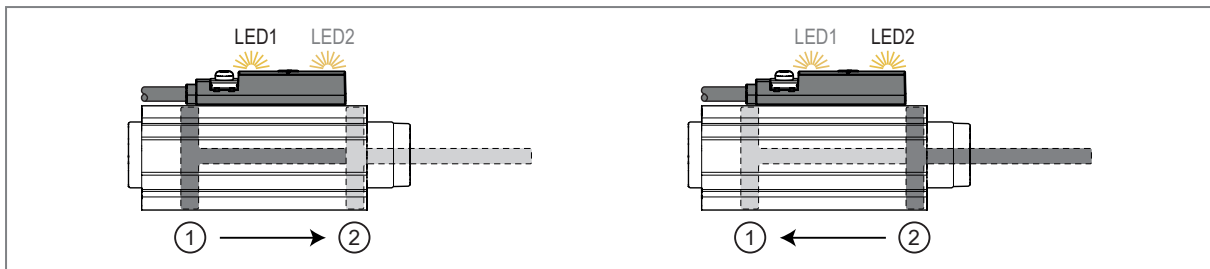

Fig. 11: Stroke time monitoring when changing end positions 1 --> 2 or when changing end positions 2 --> 1.

	Parameter	Explanation
(A)	[Current actuator runtime 1 --> 2] [Current actuator runtime 2 --> 1]	Actual time required for the change between both end positions. The value can only be read.
(B)	[Reference actuator runtime 1 --> 2] [Reference actuator runtime 2 --> 1]	Required time for the change between both end positions.
(C)	[Tolerance actuator runtime 1 --> 2] [Tolerance actuator runtime 2 --> 1]	Tolerated difference between (A) and (B).

Tab. 1: Parameters for stroke time monitoring

#### Example:

[Reference actuator runtime 1 --> 2]: 1000 ms

[Tolerance actuator runtime 1 --> 2]: 400 ms

If the [Current actuator runtime 1 --> 2] is less than 600 ms, the event "actuator runtime not reached" will be activated.

If the [Current actuator runtime 1 --> 2] is more than 1400 ms, the event "actuator runtime exceeded" will be activated.



Setting range of the tolerance actuator runtime: 20...20 000 ms. Values outside the setting range will be automatically corrected to the minimum or maximum value during application teach.

#### Manual parameter setting

- ▶ Parameter setting of switching signal channels SSC1.1 and SSC1.2 (→ [Detecting two end positions \(short-stroke cylinder\)](#) □ 25).
- ▶ Call up [Parameters] > [Output Configuration].
- ▶ Select [oux] and set the diagnostic function for output OUTx: [dOU / diagnostic output].
- ▶ Select [dFUx] and set [TimeoutOn / Timeout 1 --> 2] or [TimeoutOff / Timeout 2 --> 1].
- ▶ Select [Parameter] > [Signal].
- ▶ Select and set the [Reference actuator runtime x --> y.]  
-or-  
execute command: [ Apply Reference actuator runtime x --> y] to adopt the value of the last stroke time.
- ▶ Select and set the [Tolerance actuator runtime x --> y].

#### Parameter setting via teach:

- ▶ Performing application teach (→ [Teach In Application](#) □ 18):
  - ▷ The device recognises minimum and maximum values as end positions after the piston rod has been moved in and out three times and independently sets the switch points for SSC1.1 and SSC1.2 with the mode [Single Point].
  - ▷ The average runtime for the piston rod moving in and out is taken as the [Reference actuator runtime x --> y].
  - ▷ The tolerance time is set automatically:  
[Tolerance actuator runtime x --> y] = 50 % of [Current actuator runtime x --> y].

## 9.8.2 Switching cycle monitoring

The device stores the number of switching cycles on the switching signal channels SSC1.1 (counter SCT1.1) and SSC1.2 (counter SCT1.2). Depending on the set counting condition, individual switching edges or piston strokes (two switching edges) will be counted.

The counter value can be read via the IO-Link interface.

If the hardware output is used for diagnostics, the switching state changes when a set switching cycle threshold is reached. When using the IO-Link interface, a data bit is set. The change of state applies for a defined hold time or until the counter is reset.

### 9.8.2.1 Configuring counters

The switching cycle counters SCT1.1 and SCT1.2 are configured separately. A counter with all its parameter settings is assigned to the hardware output via the output configuration.

Parameter	Explanation
SSC-EnhCtr_HoldTime. SSC1.1 SSC-EnhCtr_HoldTime. SSC1.2	Hold time: duration of the changed switching status when reaching the switching cycle threshold in milliseconds. Requirement: [SSC-EnhCtr_AutoReload. SSC1.x] = On.
SSC-EnhCtr_AutoReload. SSC1.1 SSC-EnhCtr_AutoReload. SSC1.2	Counter reset: <ul style="list-style-type: none"> <li>• OFF: The output switches when the switching cycle threshold is reached. The counter continues counting until it is reset: Reset counter to zero (→ <a href="#">Reset counters</a> ▢ 24).</li> <li>• On: The output switches when the switching cycle threshold is reached. The switching status remains active for the set hold time [SSC-EnhCtr_HoldTime. SSC1.x]. Afterwards, the switching output and the counter are reset. The counter starts again at 0.</li> </ul>
SSC-EnhCtr_CountCondition. SSC1.1 SSC-EnhCtr_CountCondition. SSC1.2	Count condition: <ul style="list-style-type: none"> <li>• Rising: The counter only adds up switching cycles when changing from low to high (0 → 1).</li> <li>• Falling: The counter only adds up switching cycles when changing from high to low (1 → 0).</li> <li>• Both: The counter adds up the switching cycles on both edges.</li> </ul> ▶ Observe the switch point logic (→ <a href="#">Switch point logic</a> ▢ 19).
SSC-EnhCtr_Threshold. SSC1.1 SSC-EnhCtr_Threshold. SSC1.2	Switching cycle threshold: Number of switching cycles at counter SCT1.x at which a switching signal is triggered or the SCT1.x bit is set.

Tab. 2: Parameters for switching cycle monitoring

#### Parameter setting:

- ▶ Call up [Parameters] > [Output Configuration].
- ▶ Select [oux] and set the diagnostic function for output OUTx: [dOU / diagnostic output].
- ▶ Select [dFUx] and select the counter for the diagnostic output: [Overflow SCT1.1] or [Overflow SCT1.2].
- ▶ Select [Parameters] > [Counter configuration].
- ▶ [SSC-EnhCtr\_HoldTime. SSC1.x] and set the hold time for counter SCT1.x.
- ▶ [SSC-EnhCtr\_AutoReload. SSC1.x] and set counter reset for counter SCT1.x.
- ▶ [SSC-EnhCtr\_CountCondition. SSC1.x] and set the counting condition for counter SCT1.x.
- ▶ Select [SSC-EnhCtr\_Threshold. SSC1.x] and set the switching cycle threshold for counter SCT1.x.

### 9.8.2.2 Read counter values

- ▶ Select [Parameters] > [Counter configuration].
- ▶ Select [SSC-EnhCtr. SSC1.1] and read the current value for counter SCT1.1.

- ▶ Select [SSC-EnhCtr. SSC1.2] and read the current value for counter SCT1.2.

### 9.8.2.3 Reset counters

Reset both counters:

- ▶ Select [Parameters] > [Counter configuration].
- ▶ Execute command: [Reset counter to zero].
- ▷ Both switching cycles counters are set to 0.

Reset counters individually:

- ▶ Select [Parameters] > [Counter configuration].
- ▶ Execute command: [Reset SCT1.x counter].
- ▷ The switching cycles counter SCT1.x is set to 0.

## 9.8.3 Magnetic field monitoring

The device measures the magnetic field strength and provides this value via the IO-Link interface. The magnetic field must be in the range  $1 \text{ mT} < \text{Babs} < 20 \text{ mT}$  (→ [Measuring principle](#) 7).

When using the diagnostic output, the sensor can output a switching signal as soon as the magnetic field strength is outside the valid range.

- ▶ Read the current magnetic field strength: [Parameter] > [Signal].

### 9.8.3.1 Configuring magnetic field monitoring

- ▶ Call up [Parameters] > [Output Configuration].
- ▶ Select [oux] and set the diagnostic function for output OUTx: [dOU / diagnostic output].
- ▶ [dFUx] and set the trigger for the switching signal: [NoData / No data]

## 9.8.4 Operating hours counter

The operating hours since the first set-up are stored by the unit.

The operating hours counter is stored retentively every hour. If the operating voltage is interrupted, the time since the last full hour will be lost.

The maximum counter reading of 2,000,000 h will be retained when it has been reached (no overflow).

The current value can be read via the IO-Link interface.

- ▶ Select [Diagnosis].
- ▶ Select [Operating hours] and read value.

## 9.8.5 Power cycles

The device stores the switch-on operations since the first set-up.

The maximum counter reading of 2,000,000 will be retained when it has been reached (no overflow).

- ▶ Select [Diagnosis].
- ▶ Select [Power cycles] and read value.

## 9.8.6 Internal temperature

The sensor measures the internal temperature.



The internal temperature may be higher than the actual temperature due to self-heating of the processor.

Due to the installation in the cylinder groove, the temperature of the device is strongly coupled to the temperature of the cylinder housing. If the cylinder becomes excessively warm due to wear or overload, this trend can be detected with the device.

- ▶ Select [Diagnosis] > [Temperature].
- ▶ Select [Internal temperature] and read value.

## 9.9 Parameter setting examples

### 9.9.1 Detecting two end positions (short-stroke cylinder)

If the stroke of a short-stroke cylinder does not exceed the measuring range of the device, two end positions can be displayed with one device.

The device detects both end positions of the short-stroke cylinder. The switching signal channels show the following:

- SSC1.1 indicates that the cylinder is in end position 1.
- SSC1.2 indicates that the cylinder is in end position 2.



In this example, the south pole of the magnet is oriented towards the cylinder rod, therefore the signal falls when the cylinder is extended (→ [Signal direction](#) 19).

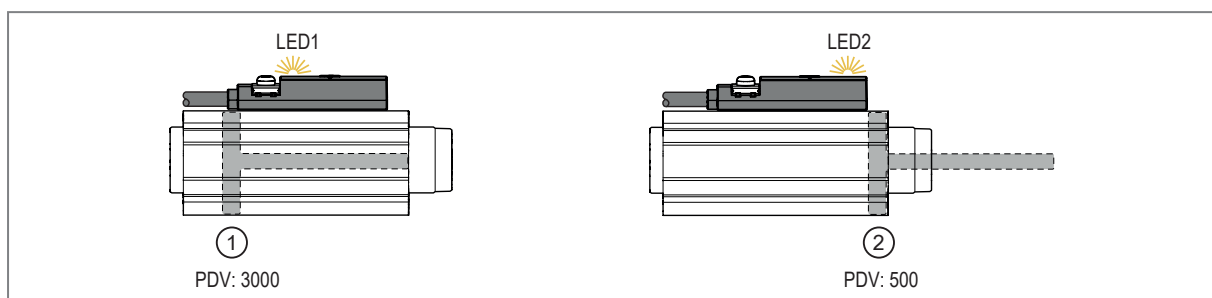
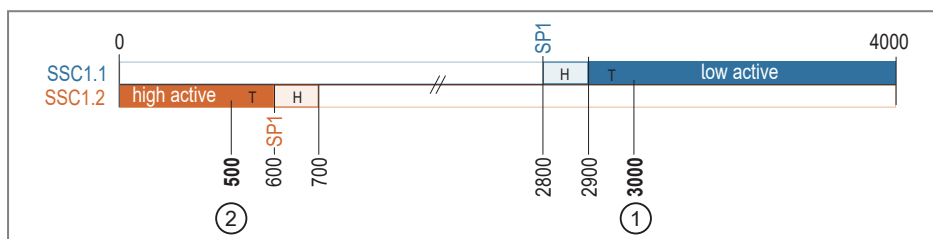

Fig. 12: Detecting two end positions

- 1: Cylinder in end position 1 (piston in): LED1 is on. SSC1.1 is active.
- 2: Cylinder in end position 2 (piston out): LED2 is on. SSC1.2 is active.

#### Parameter setting example “manual switch point configuration” (2x single point mode):



T: tolerance  
H: hysteresis

- ▶ Installing and connecting the device.
- ▶ Retract the cylinder to end position 1, read the current process data value (PDV) and note it down (3000 in the example).
- ▶ Select [SSC1.1 Config. Mode] and set [Single point].
- ▶ Calculate and set the switch point SP1 for switching signal channel SSC1.1:  
[SSC1.1 Param. SP1] = 3000 (PDV) - 100 (tolerance) - 100 (hysteresis) = 2800
- ▶ Select [SSC1.1 Config. Logic] and set [Low active].
- ▶ Save the parameter set and write it to the device.

- ▶ Extend the cylinder to end position 2, read the current process data value (PDV) and note it down (500 in the example).
- ▶ Select [SSC1.2 Config. Mode] and set [Single point].
- ▶ Calculate and set the switch point SP1 for switching signal channel SSC1.2:  
[SSC1.2 Param. SP1] = 500 (PDV) + 100 (tolerance) = 600.
- ▶ Select [SSC1.2 Config. Logic] and set [High active].
- ▶ Save the parameter set and write it to the device.

### Parameter setting example Section Teach (2x Window Mode):

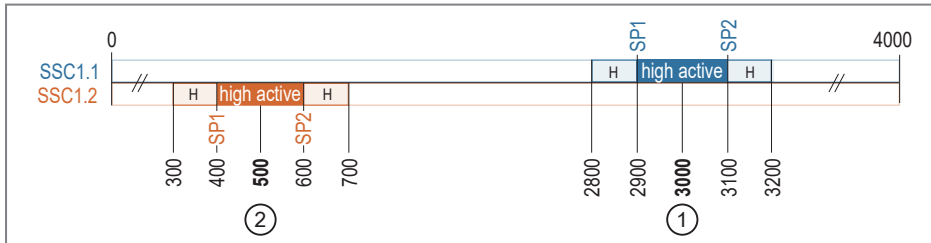

H: hysteresis

- ▶ Installing and connecting the device.
- ▶ Extend the cylinder to end position 2.
- ▶ Select [Parameter] > [Teach] > [Teach Single Value].
- ▶ Select [TI Select ] and set [SSC1.1].
- ▶ Save the parameter set and write it to the device.
- ▶ Select [Parameter] > [Teach] > [Teach Custom].
- ▶ Execute command: [Section Teach].
- ▶ Select [SSC1.1 Config. Logic] and set [High active].
- ▶ Save the parameter set and write it to the device.
- ▶ Retract the cylinder to end position 1.
- ▶ Select [Parameter] > [Teach] > [Teach Single Value].
- ▶ Select [TI Select ] and set [SSC1.2].
- ▶ Save the parameter set and write it to the device.
- ▶ Select [Parameter] > [Teach] > [Teach Custom].
- ▶ Execute command: [Section Teach].
- ▶ Select [SSC1.1 Config. Logic] and set [High active].
- ▶ Save the parameter set and write it to the device.

## 9.9.2 Inline material detection

When operating in Window Mode, objects can be detected, compared and counted.

In this application example, the device is installed in a cylinder that clamps 2 sheets together for welding.

The device detects whether the correct number of sheets has been inserted. The switching signal channels control the process via their output signals by means of the switch point logic set in opposite directions:

- SSC1.1 indicates correct clamping and releases the welding process.
- SSC1.2 indicates errors and stops the welding process.



In this example, the north pole of the magnet is oriented towards the cylinder rod, therefore the signal increases when the cylinder rod is extended and corresponds to the specified Function Class "Object Detection" (→ [Signal direction](#) 19).

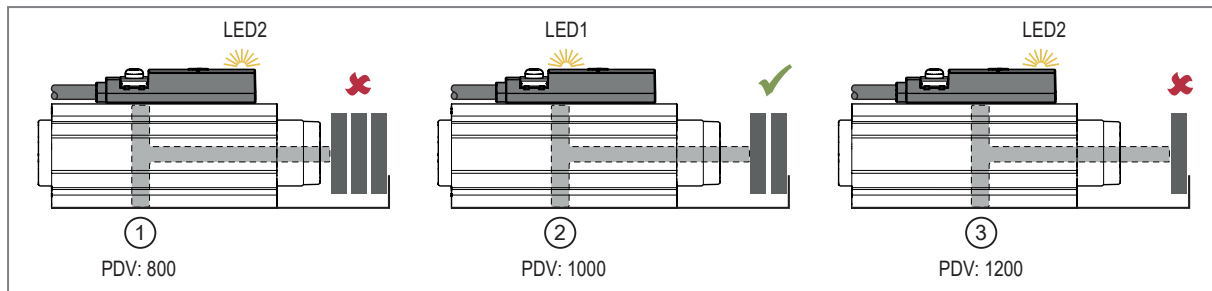
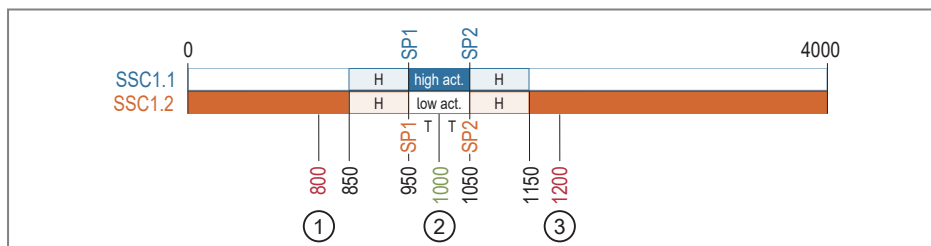

Fig. 13: Inline material detection

- 1: Cylinder detects 3 sheets: LED2 is on / SSC1.2 is active. SSC1.1 is inactive.
- 2: Cylinder detects 2 sheets: LED1 is on / SSC1.1 is active. SSC1.2 is inactive.
- 3: Cylinder detects 1 sheet: LED2 is on / SSC1.2 is active. SSC1.1 is inactive.

### Parameter setting example “manual switch point configuration” (2x window mode):



H: hysteresis  
T: tolerance

- ▶ Installing and connecting the device.
- ▶ Insert 2 sheets and extend the cylinder for clamping.
- ▶ Select [SSC1.1 Config. Mode] and set [Window].
- ▶ Read the current process data value [PDV] and write it down (1000 in the example).
- ▶ Calculate and set the switch points for switching signal channel SSC1.1:  
[SSC1.1 Param. SP1] = 1000 (PDV) - 50 (tolerance) = 950  
[SSC1.1 Param. SP2] = 1000 (PDV) + 50 (tolerance) = 1050
- ▶ Select [SSC1.1 Config. Logic] and set [High active].
- ▶ Save the parameter set and write it to the device.
- ▶ Select [SSC1.2 Config. Mode] and set [Window].
- ▶ Set the same switch points as for switching signal channel SSC1.1:  
[SSC1.2 Param. SP1] = 950  
[SSC1.2 Param. SP2] = 1050
- ▶ Select [SSC1.2 Config. Logic] and set [Low active].
- ▶ Save the parameter set and write it to the device.
- ▶ Set the parameters [SSC1.1 On Delay], [SSC1.1 Off Delay], [SSC1.2 On Delay] and [SSC1.1 Off Delay] all to 25 ms and write to the device.
- ▷ Magnetic interference fields caused by large welding currents are suppressed. No false switching pulses occur during welding.



- ▶ Depending on the sheet thickness or object size, adjust the values for tolerance and hysteresis.

### 9.9.3 Soiling indication

In this application example, the device is installed in a cylinder that clamps a workpiece to be machined. Due to abrasion and chips, the clamping device must be cleaned regularly.

The switching signal channels show the following:

- SSC1.1 shows a correctly clamped workpiece.
- SSC1.1 and SSC1.2 together indicate tolerable soiling and a warning is issued.
- SSC1.2 indicates intolerable soiling of the clamping device.

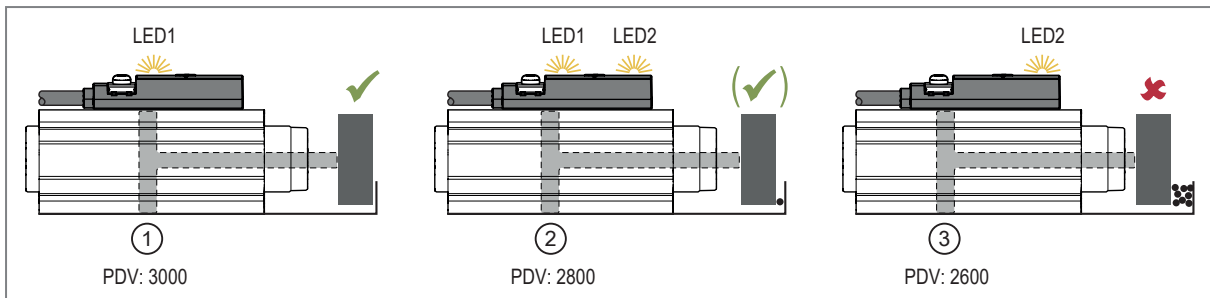
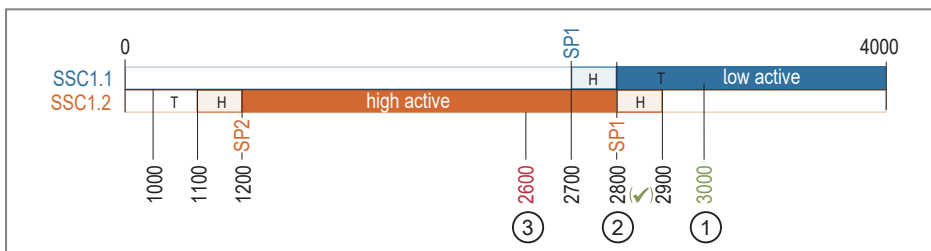

Fig. 14: Soiling indication

- 1: No soiling: LED1 is on. SSC1.1 is active.  
 2: Tolerable soiling: LED1 and LED2 are on. SSC1.1 and SSC1.2 are active.  
 3: Heavily soiled: LED2 is on. SSC1.2 is active.

### Parameter setting example “manual switch point configuration” (Single Point / Window Mode):



H: hysteresis  
 T: Tolerance

- ▶ Installing and connecting the device.
- ▶ Insert the workpiece into the clean fixture and extend the cylinder for clamping.
- ▶ Select [SSC1.1 Config. Mode] and set [Single Point].
- ▶ Read the current process data value [PDV] and write it down (3000 in the example).
- ▶ Calculate and set the switch point SP1 for switching signal channel SSC1.1:  
 $[SSC1.1 \text{ Param. SP1}] = 3000 \text{ (PDV)} - 200 \text{ (tolerance)} - 100 \text{ (hysteresis)} = 2700$
- ▶ Select [SSC1.1 Config. Logic] and set [Low active].
- ▶ Save the parameter set and write it to the device.
- ▶ Retract the cylinder completely.
- ▶ Select [SSC1.2 Config. Mode] and set [Window].
- ▶ Calculate and set the switch points for switching signal channel SSC1.2:  
 $[SSC1.2 \text{ Param. SP1}] = 3000 \text{ (PDV for one workpiece)} - 100 \text{ (}\frac{1}{2}\text{ tolerance)} - 100 \text{ (hysteresis)} = 2800$   
 $[SSC1.2 \text{ Param. SP2}] = 1000 \text{ (PDV retracted cylinder)} + 100 \text{ (tolerance)} + 100 \text{ (hysteresis)} = 1200$
- ▶ Select [SSC1.2 Config. Logic] and set [High active].
- ▶ Save the parameter set and write it to the device.
- ▶ Set the parameter [SSC1.2 switch-on delay] to 500 ms and write to the device.
- ▷ No soiling is indicated if the clamping device passes through the soiling area within 500 ms. Only when the clamping device comes to a stop in the soiling area, soiling will be signalled.

## 9.10 Resetting the device

The unit can be reset in 2 ways:

- [Application Reset]: reset of the parameter settings. The following is reset:
  - All changed application-specific parameters and teaches.
- [Back-to-box]: reset to factory settings. The following is reset:
  - All changed application-specific parameters and teaches.
  - All writeable unit identification parameters such as [Application Specific Tag], [Function Tag] or [Location Tag].
  - Diagnostic parameters, status parameters, events.

After the Back to Box reset, the sensor suspends communication and measurement operation until the voltage is interrupted. The IO-Link data storage is not triggered.



We recommend documenting your own settings in the chapter Factory setting before carrying out a reset.

#### **Parameter setting:**

- ▶ Select [Parameters] > [Setup].
- ▶ Execute command: [Application reset] or [Back-to-Box].
- ▶ Disconnect and reconnect the power supply.
- ▷ The device carries out a reboot.

## **9.11 Identification**

### **9.11.1 Device information**

Unalterable device information is stored on the unit. This includes:

- Product name
- Product family
- Manufacturer
- Manufacturer ID
- Device ID
- Serial number
- Hardware / firmware revision
- Description

In addition, further freely definable tags with a maximum length of 32 characters can be assigned to the unit via the IO-Link interface using suitable parameter setting software. This includes:

- application-specific tag
- function tag
- location tag

#### **Read/edit device information:**

- ▶ Select [Identification].
- ▶ Read device information or edit editable parameters.

### **9.11.2 Optical localisation**

The sensor can be located remotely in the system via the IO-Link interface.

When using the command, both switching status LEDs will flash yellow.

- ▶ Select [Identification].
- ▶ Execute command: [Locator Start].
- ▶ To end the flashing process: Execute command: [Locator Stop].

## 10 Operation

After power-on and the required parameter setting the device is in the operating mode. It carries out its measurement and evaluation functions and generates output signals according to the set parameters.

- ▶ Check whether the device operates correctly.

## 11 Troubleshooting

Display / problem	Cause / remedy
Both yellow switching status LEDs flash alternately at 5 Hz	Hardware fault or electronic fault in the device. ▶ Restart the device. ▶ If the condition persists, replace the device.
Both yellow switching status LEDs flash simultaneously at 5 Hz	Short circuit on output OUT1 and / or OUT2 <sup>1)</sup> . ▶ Remove the short circuit.
One or both switching status LEDs light up yellow although the sensor is not damped by a magnet.	The device remembers the last valid measured value and switches the outputs accordingly. This shows which side of the sensor the magnet is on, even if the magnetic field becomes too weak. ▶ Move past the device with a magnet to switch off the LEDs. ▷ Depending on the setting, the LEDs will be switched on with one pole of the magnet and switched off with the other polarity. When operating in Window Mode, the LEDs are usually switched off with both polarities. See also <a href="#">Signal direction</a> (→ □ 19).
The green LED is off.	▶ Check power supply and wiring.
Switching status LEDs are reversed. When the cylinder is in the right end position, the left switching status LED goes on and vice versa.	The yellow switching status LED on the cable side is always assigned to switching signal channel 1. ▶ Swap the assignment manually by swapping all parameters that affect the switching behaviour between switching signal channel 1 and switching signal channel 2. -or- ▶ Invert the signal direction before an application teach (→ <a href="#">Signal direction</a> □ 19).
Error after switch point [Teach SPx]: The cylinder is in the end position and a switch point teach has been carried out. When the cylinder returns to the end position, the device will not switch.	With the switch point teach, the switch point is shifted by the hysteresis to the teach point. Depending on the signal direction, the teach point is outside the operating range. ▶ Manually reduce the switch point by 2 times the hysteresis. ▶ Use section teach instead of switch point teach.
Error after [Teach In Application]: The application teach was carried out successfully, but only one end position is recognised correctly. The parameters of the other switching signal channel have not been changed.	Before the application teach, [TI Select] was not selected [All SSC]. If the application teach is successful, only the switching signal channel selected at [TI Select] will be configured with the newly determined parameters. ▶ Select [Parameter] > [Teach] > [Teach Single Value]. ▶ Select [Parameter] > [Teach] > [Teach Custom] > [TI Select] and set [All SSC]. ▶ Execute the application teach again.
IO-Link event "block parameter setting error": The device does not accept the values for configuring a switching signal channel.	The switch points [SP1] and/or [SP2] were set to the limits of the measuring range. However, the switch points must be further within the limits of the measuring range by at least the value of the hysteresis. ▶ Reduce hysteresis. ▶ Shift the switch points further inwards. ▶ Move the device in the groove so that the switch points will be further in the middle of the measuring range.
IO-Link event "measuring signal disturbed"	Magnetic field too strong or too weak. ▶ Ensure that the field strength is within the specified range. ▷ Move sensor to valid area

<sup>1)</sup> In the event of a short circuit at OUT2 (only for units with two outputs), the "short circuit" event will be provided via the IO-Link interface.

## 12 Maintenance, repair and disposal

The unit is maintenance-free.

Only the manufacturer is allowed to repair the unit.

- ▶ In case of return shipment, ensure that the unit is free from soiling, especially from dangerous and toxic substances.
- ▶ For transport only use appropriate packaging to avoid damage of the unit.
- ▶ After use, dispose of the unit in an environmentally friendly way in accordance with the applicable national regulations.



## 13 Factory settings

Parameter	Factory setting	User settings
TI Select	SSC1.1	
SSC1.1 Param. SP1	1800	
SSC1.1 Param. SP2 <sup>1)</sup>	2200	
SSC1.1 Config. Logic	High active	
SSC1.1 Config. Mode	Window	
SSC1.1 Config. Hyst <sup>1)</sup>	100	
SSC1.1 Switch-On delay	0 ms	
SSC1.1 Switch-Off delay	0 ms	
SSC1.2 Param. SP1	1900	
SSC1.2 Param. SP2 <sup>1)</sup>	2100	
SSC1.2 Config. Logic	High active	
SSC1.2 Config. Mode	Window	
SSC1.2 Config. Hyst <sup>1)</sup>	100	
SSC1.2 Switch-On delay	0 ms	
SSC1.2 Switch-Off delay	0 ms	
Output configuration ou1	SSC1.1	
Diagnostic output dFU1 <sup>3)</sup>	Overflow SCT1.1	
Output configuration ou2 <sup>2)</sup>	SSC1.2	
Diagnostic output dFU2 <sup>3)2)</sup>	Overflow SCT1.2	
SSC-EnhCtr_AutoReload. SSC1.x	OFF	
SSC-EnhCtr_HoldTime. SSC1.x	10000 ms	
SSC-EnhCtr_Threshold.SSC1.x	0	
SSC-EnhCtr_CountCondition.SSC1.x	Rising	
Signal direction	Not inverted	
Actuator reference runtime 1 --> 2	0 ms	
Actuator runtime tolerance 1 --> 2	Deactivated	
Actuator reference runtime 2 --> 1	0 ms	
Actuator runtime tolerance 2 --> 1	0 ms	

<sup>1)</sup> The parameter will only be displayed if other parameters have been set accordingly beforehand.

<sup>2)</sup> The parameter is only available for devices with 2 outputs (→ [Function □ 7](#)).

<sup>3)</sup> The parameter will be displayed, but the setting will only take effect if [oux] = [dOU] has been selected.