

ifm electronic



Operating instructions
Compressed air meters

efector 300[®]

SD5100

SD6100

SD8100

UK

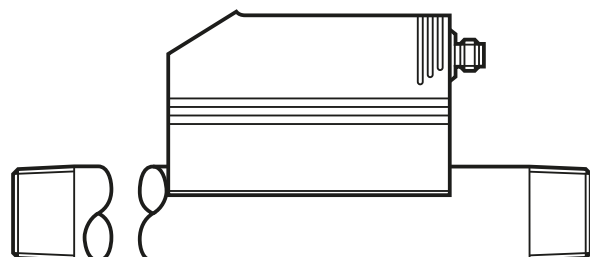
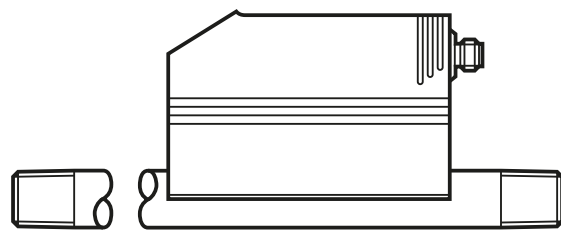
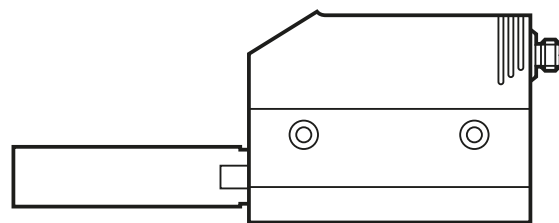

11406632 / 00 11 / 2014

Contents

1	Preliminary note.....	4
1.1	Symbols used	4
2	Safety instructions	4
3	Functions and features	5
4	Function.....	6
4.1	Process measured signals	6
4.2	Volumetric flow monitoring.....	6
4.3	Consumed quantity monitoring (totaliser function)	6
4.3.1	Consumed quantity monitoring with pulse output.....	7
4.3.2	Consumed quantity monitoring with preset counter	7
4.4	Temperature monitoring.....	7
4.5	Volumetric flow or temperature monitoring / switching function.....	8
4.5.1	Hysteresis function	8
4.5.2	Window function	8
4.6	Volumetric flow or temperature monitoring / analogue function.....	9
4.7	Set standard conditions of the volume flow	10
4.8	Low flow cut-off (LFC).....	10
5	Installation.....	11
5.1	Installation location	11
5.2	Installation conditions	11
5.3	Installation position	12
5.4	Installation in pipes	13
6	Electrical connection.....	14
7	Operating and display elements	15
8	Menu.....	16
8.1	Main menu.....	16
8.2	Extended functions	18
9	Set-up	19
10	Parameter setting	20
10.1	IO-Link	20
10.1.1	General information	20
10.1.2	Device-specific information.....	20

10.1.3	Parameter setting tools.....	20
10.2	Parameter setting in general	21
10.2.1	Change from menu level 1 to menu level 2:.....	21
10.2.2	Locking / unlocking	22
10.2.3	Timeout.....	22
10.3	Settings for consumed quantity monitoring	22
10.3.1	Configure limit value monitoring with OUT1	22
10.3.2	Configure limit value monitoring with OUT2	23
10.3.3	Configure analogue value for volumetric flow.....	23
10.4	Settings for consumed quantity monitoring	23
10.4.1	Configure quantity monitoring via pulse output	23
10.4.2	Configure quantity monitoring via the preset counter	23
10.4.3	Setting the pulse value	24
10.4.4	Manual counter reset.....	25
10.4.5	Time-controlled counter-reset.....	25
10.4.6	Deactivate meter reset	25
10.4.7	Configure meter reset using an external signal	25
10.5	Settings for temperature monitoring	26
10.5.1	Configure limit value monitoring with OUT2	26
10.5.2	Configure analogue value for temperature	26
10.6	User settings (optional).....	26
10.6.1	Set standard unit of measurement for volumetric flow	26
10.6.2	Configuration of the standard display	27
10.6.3	Set measured value damping.....	27
10.6.4	Set output status in fault condition.....	27
10.6.5	Set standard pressure	27
10.6.6	Set standard temperature	28
10.6.7	Set low flow cut-off	28
10.6.8	Select the medium to be monitored.....	28
10.7	Service functions	28
10.7.1	Read min/max values for volumetric flow.....	28
10.7.2	Reset all parameters to factory setting.....	28
11	Operation	29
11.1	Reading the process value	29
11.2	Change display unit in the Run mode	29
11.3	Read set parameters	30
11.4	Fault indications	30

UK

11.5 General operating conditions	30
12 Technical data and scale drawing	30
13 Factory setting	31

1 Preliminary note

1.1 Symbols used

- ▶ Instructions
- > Reaction, result
- [...] Designation of keys, buttons or indications
- Cross-reference



Important note

Non-compliance can result in malfunction or interference.



Information

Supplementary note.

2 Safety instructions

- Please read this document prior to set-up of the unit. Ensure that the product is suitable for your application without any restrictions.
- If the operating instructions or the technical data are not adhered to, personal injury and/or damage to property can occur.
- Ensure before mounting the components into or removing them from the compressed air system that the installation is at a standstill and no pressure is applied.
- Improper or non-intended use may lead to malfunctions of the unit or to unwanted effects in your application. That is why installation, electrical connection, set-up, operation and maintenance of the unit must only be carried out by qualified personnel authorised by the machine operator.
- In order to guarantee the correct condition of the device for the operating time it is necessary to use the device only for media to which the wetted materials are sufficiently resistant (→ Technical data).
- The responsibility whether the measurement devices are suitable for the respective application lies with the operator. The manufacturer assumes no

liability for consequences of misuse by the operator. Improper installation and use of the devices results in a loss of the warranty claims.

- Correct operation and compliance with the measurement accuracy can only be ensured if the environmental conditions specified in the technical data are adhered to. Ensure that the maximum pressure range, measuring range and permitted ambient temperature are not exceeded.

3 Functions and features

The unit monitors the standard volume flow of gases.

It detects the 4 process variables flow velocity, volumetric flow quantity, consumed quantity, medium temperature.

UK

- Application:
 - Argon (Ar)
 - Carbon dioxide (CO₂)
 - Nitrogen (N₂)
- Selection of the medium to be monitored → 10.6.8.
- All indications apply to standard volume flow to DIN ISO 2533, i.e. volume flow at 1013 hPa, 15 °C and 0 % relative air humidity. The unit can be set to different standard conditions (→ 10.6.5 and → 10.6.6).
- The general operating conditions of systems with gas filling apply.
- Pressure Equipment Directive (PED): Devices with a measuring section comply with art. 3 sec. (3) of the Directive 97/23/EC and are designed and manufactured for stable gases of the fluid group 2 in accordance with sound engineering practice.

4 Function

4.1 Process measured signals

The unit displays the current process values.

It generates 2 output signals according to the parameter setting.

OUT1: 4 selection options	Parameter setting
- Switching signal for volumetric flow quantity limit value	→ 10.3.1
- or switching signal for flow velocity limit value	→ 10.3.1
- or pulse signal for quantity meter	→ 10.4.1
- or switching signal for preset counter	→ 10.4.2

OUT2: 6 selection options	Parameter setting
- Switching signal for volumetric flow quantity limit value	→ 10.3.2
- or switching signal for flow velocity limit value	→ 10.3.2
- or switching signal for temperature limit value	→ 10.5.1
- or analogue signal for volumetric flow quantity	→ 10.3.3
- or analogue signal for flow velocity	→ 10.3.3
- or analogue signal for temperature	→ 10.5.2

If not used as an output, OUT2 (pin 2) can instead be used as an input for an external reset signal → 10.4.7

4.2 Volumetric flow monitoring

The volumetric flow is monitored by a calorimetric measuring system, the measured signals are evaluated by the electronics.

The signals for measuring the volumetric flow quantity can be provided as follows:

1. Two switching signals for volumetric flow quantity limit values on output 1 and output 2 (→ 4.5).
2. An analogue signal proportional to the volumetric flow (4...20 mA) on output 2 (→ 4.6).

4.3 Consumed quantity monitoring (totaliser function)

The unit has an internal quantity meter which continuously totals the volumetric flow quantity. The sum corresponds to the current consumed quantity since the last reset.

- The current meter reading can be displayed.

- In addition the value before the last reset is saved. This value can also be displayed.



The meter saves the totalled consumed quantity every 10 minutes. After a power failure this value is available as the current meter reading. If a time-controlled reset is set, the elapsed time of the set reset interval is also saved. So the possible data loss can be maximum 10 minutes.

- Overflow: After the maximum value (9 999 999 Nm³) the meter is reset to 0.

The meter can be reset as follows:

- 10.4.4 Manual counter reset.
- 10.4.5 Time-controlled counter-reset.
- 10.4.7 Configure meter reset using an external signal.

4.3.1 Consumed quantity monitoring with pulse output

Output 1 indicates a counting pulse when the set volumetric flow quantity has been reached (→ 10.4.1).

4.3.2 Consumed quantity monitoring with preset counter

Output 1 switches when the set volumetric flow quantity has been reached (→ 10.4.2). 2 types of monitoring are possible:

1. Time-dependent quantity monitoring (→ 10.4.5 Time-controlled counter-reset):
 - If the quantity x is reached during t , output 1 switches and remains switched until the counter is reset.
 - If the quantity x is not reached after the time t has elapsed, the meter is automatically reset and counting starts again; output 1 does not switch.
2. Non time-dependent quantity monitoring (→ 10.4.6 Deactivate meter reset).
 - If the quantity x is reached, output 1 switches and remains switched until the counter is reset.

4.4 Temperature monitoring

The following signals are provided for temperature monitoring:

1. A switching signal for temperature limit values on output 2 (→ 4.5).
2. An analogue signal proportional to the volumetric flow (4...20 mA) on output 2 (→ 4.6).

4.5 Volumetric flow or temperature monitoring / switching function

OUTx changes its switching status if it is above or below the set switching limits (SPx, rPx). The following switching functions can be selected:

4.5.1 Hysteresis function

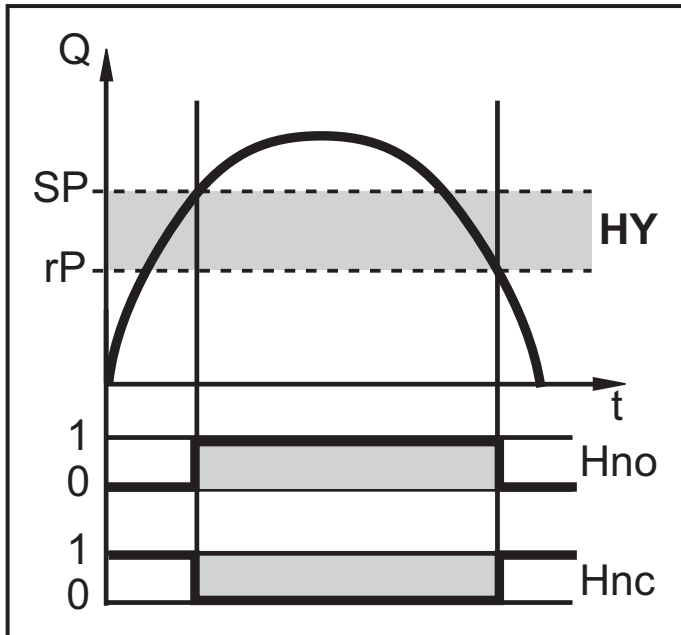

Example of volumetric flow monitoring
HY = hysteresis

Normally open: [OUx] = [Hno]

Normally closed: [OUx] = [Hnc]

First the set point (SPx) is set, then the reset point (rPx) with the requested difference.



When SPx is adjusted rPx is changed automatically; the difference remains constant.

4.5.2 Window function

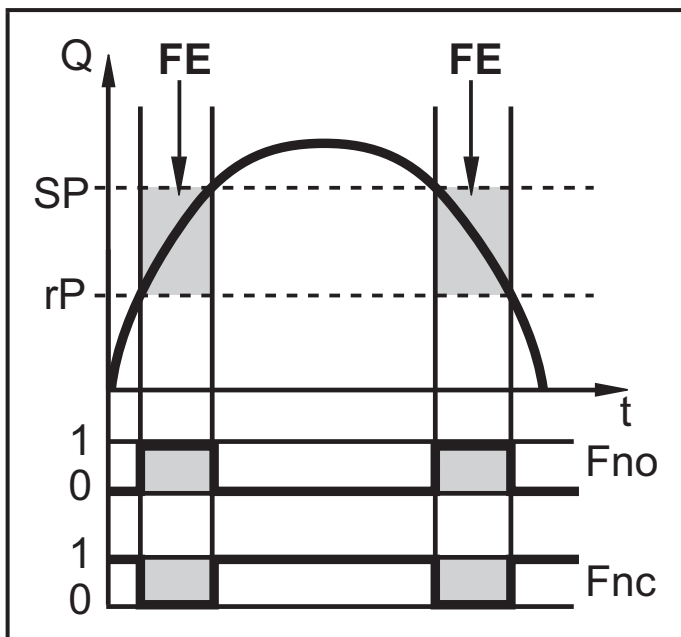

Example of volumetric flow monitoring
FE = window

Normally open: [OUx] = [Fno]

Normally closed: [OUx] = [Fnc]

The width of the window can be set by means of the difference between SPx and rPx. SPx = upper value
rPx = lower value.

4.6 Volumetric flow or temperature monitoring / analogue function

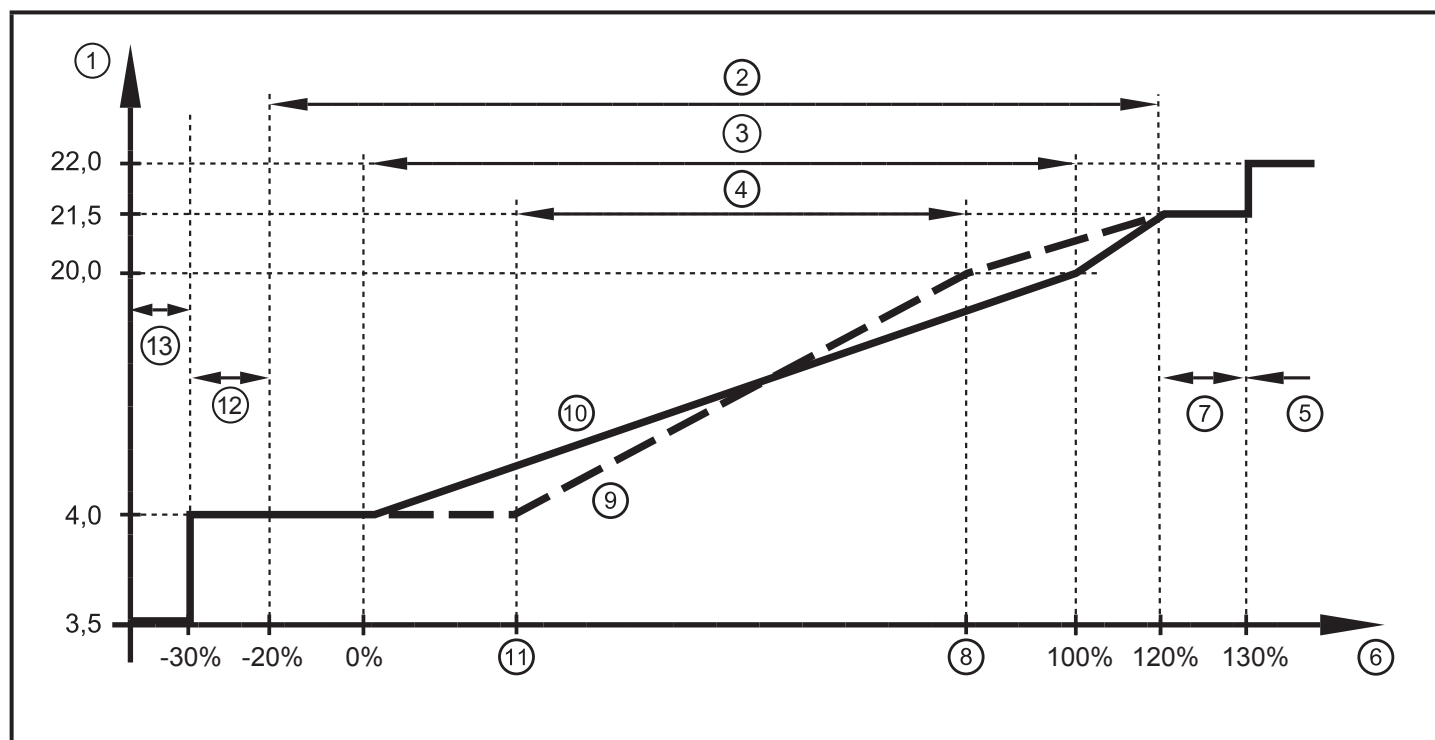

Characteristics of the analogue output according to the standard IEC 60947-5-7

1: Output current in mA

2: Operating area

3: Measuring range

4: Range between analogue start point and analogue end point

5: Error message [Err.] is displayed

6: Final value of the measuring range (VMR)

7: Error message [OL] is displayed (= overload)

8: Analogue end point (AEP): determines at which measured value the output signal is 20 mA

9: Curve of the analogue signal with shifted analogue start point

10: Curve of the analogue signal at factory setting

11: Analogue start point (ASP): determines at which measured value the output signal is 4 mA

12: Error message [UL] is displayed (= underload)

13: Error message [Err.] is displayed



Minimum distance between ASP and AEP = 25 % of the final value of the measuring range.

4.7 Set standard conditions of the volume flow

The unit is adjusted to a standard volume flow to DIN ISO 2533, i.e. volume flow at 1013 hPa, 15 °C and 0 % relative air humidity.

The unit can be set to different standard conditions:

- Via the menu item [rEF.P] the standard pressure is set, which serves as a reference for the measured and display values for volumetric flow (→ 10.6.5).
- Via the menu item [rEF.T] the standard temperature is set, which serves as a reference for the measured and display values for volumetric flow (→ 10.6.6).

4.8 Low flow cut-off (LFC)

With this function small volumetric flow quantities can be ignored (→ 10.6.7). Flows below the LFC value have no effect on the display and output signals. Example: For LFC = 0.5 volumetric flow quantities below 0.5 Nm³/h are suppressed.

5 Installation



- ▶ The rules and regulations for the installation and operation of compressed air equipment must be observed.

5.1 Installation location

- ▶ Install the unit downstream of the cold dryer.
- ▶ Install the unit near the load.
- ▶ If compressed air is fed into the main pipe through parallel pipes: mount the unit in the main pipe.
- ▶ The unit can be installed downstream of the maintenance unit. If oil is used for the loads: install the unit upstream of the oiler.



UK

5.2 Installation conditions

To achieve the specified measurement accuracy, the following installation conditions must be adhered to: defined inlet and outlet pipe lengths, defined flow cross-section area, fixed installation depth and correct positioning of the measuring elements.

The unit is mounted in a measuring range which meets these conditions.

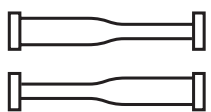
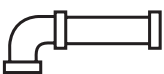
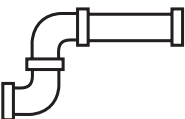
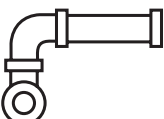
In case of disturbances on the inflow side additional calming sections (B) are recommended.

	Changes of the pipe diameter	$B = 5 \times \text{pipe diameter}$
	90° elbow	$B = 5 \times \text{pipe diameter}$
	Two 90° elbows, one plane	$B = 10 \times \text{pipe diameter}$
	Two 90° elbows, two planes	$B = 15 \times \text{pipe diameter}$
	Valve, slide	$B = 35 \times \text{pipe diameter}$

5.3 Installation position

- Permitted installation positions: pipe length vertical, any position (fig. 1, 2); pipe length horizontal, unit vertical (fig. 3, 5), unit on side, pipe length left (fig. 4).
- Avoid the installation position in fig. 6 (unit on side, pipe length right). If the flow rate is low, the specified measurement accuracy cannot be adhered to.

SD5100:

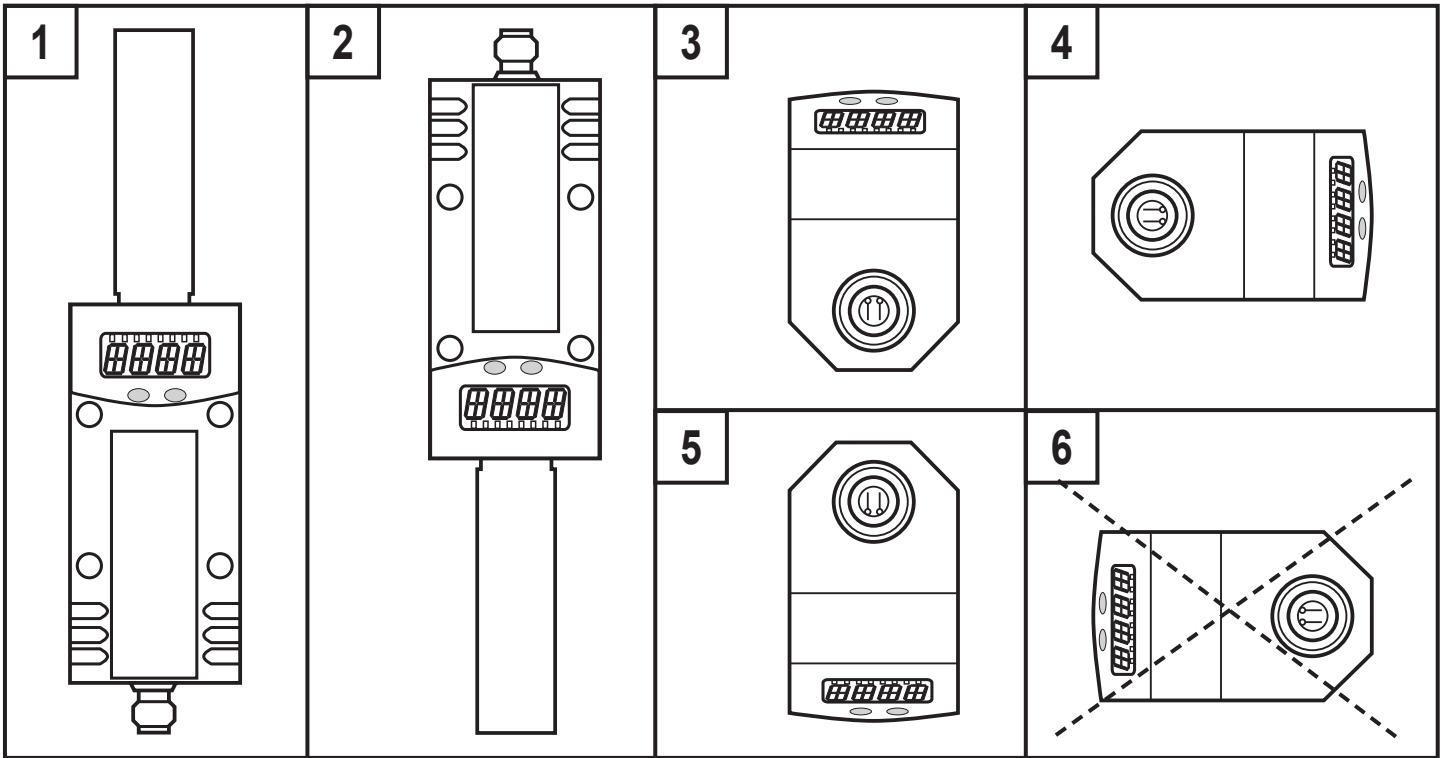

SD6100, SD8100:

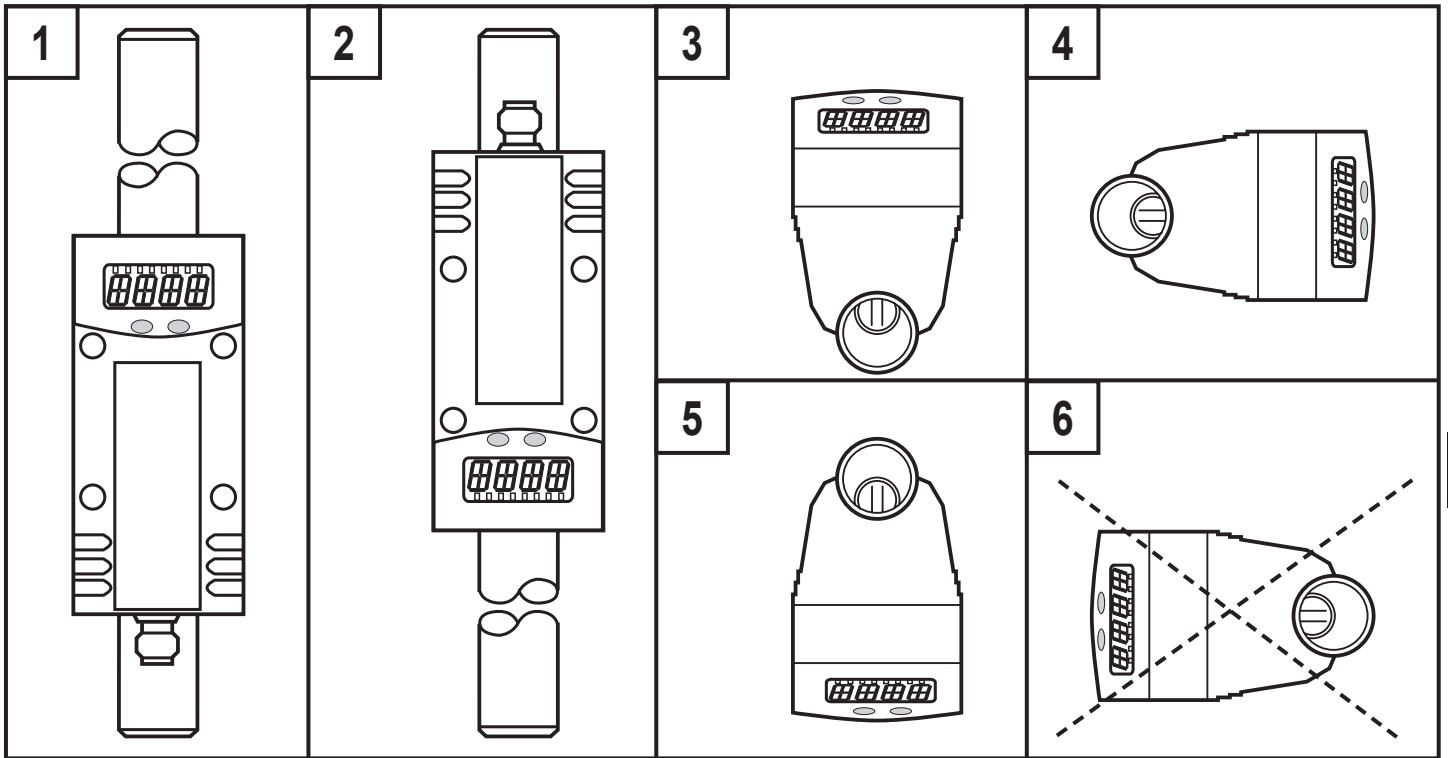

UK

5.4 Installation in pipes

- Fit the unit in the pipe in accordance with the flow direction (arrow on the unit) and tighten.

SD5100:

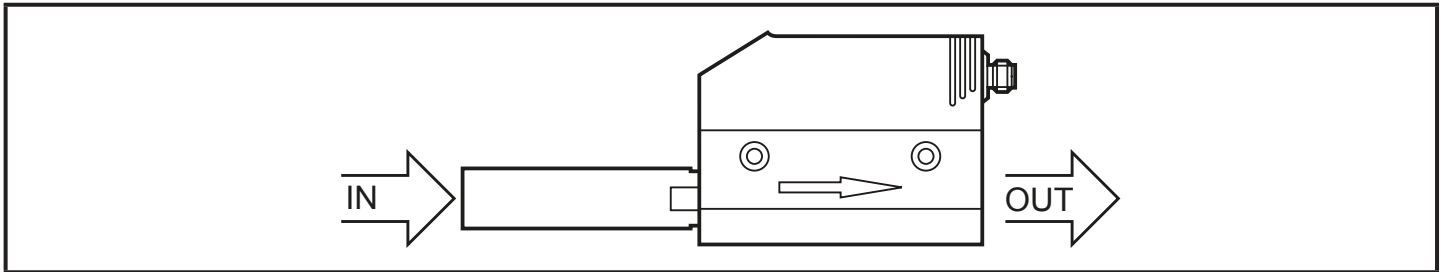

SD6100; SD8100:

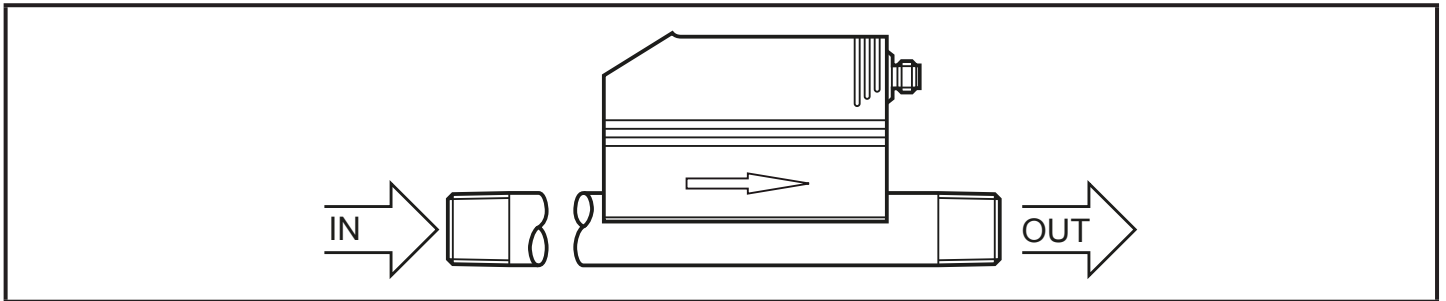

6 Electrical connection



The unit must be connected by a qualified electrician.

The national and international regulations for the installation of electrical equipment must be adhered to.

Voltage supply according to EN 50178, SELV, PELV.

- ▶ Disconnect power.
- ▶ Connect the unit as follows:

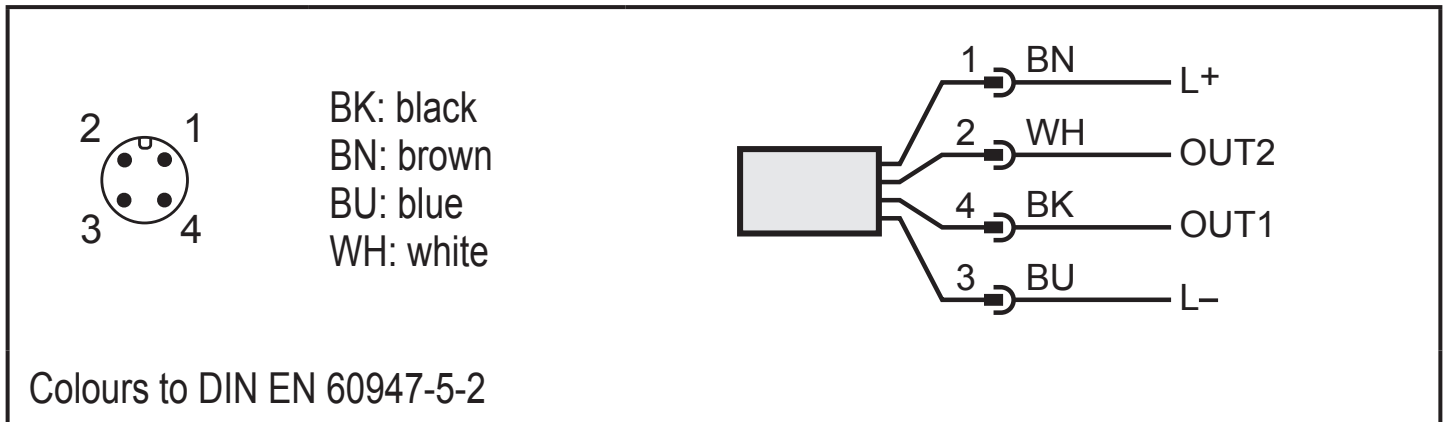

Sample circuits:

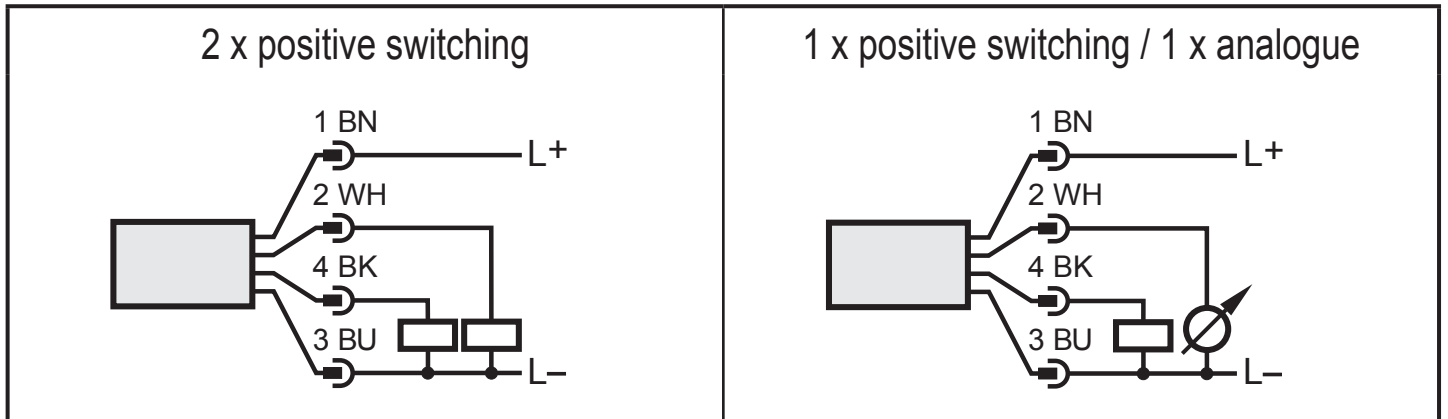

Pin 1	L+
Pin 3	L-
Pin 4 (OUT1)	<ul style="list-style-type: none"> • Switching signal: limit values for volumetric flow • Pulse signal: 1 pulse every time the defined volumetric flow quantity is reached. • Switching signal: quantity meter reached preset value • IO-Link
Pin 2 (OUT2/InD)	<ul style="list-style-type: none"> • Switching signal: limit values for volumetric flow • Switching signal: limit values for temperature • Analogue signal for volumetric flow • Analogue signal for temperature • Input for external reset signal (InD)

7 Operating and display elements

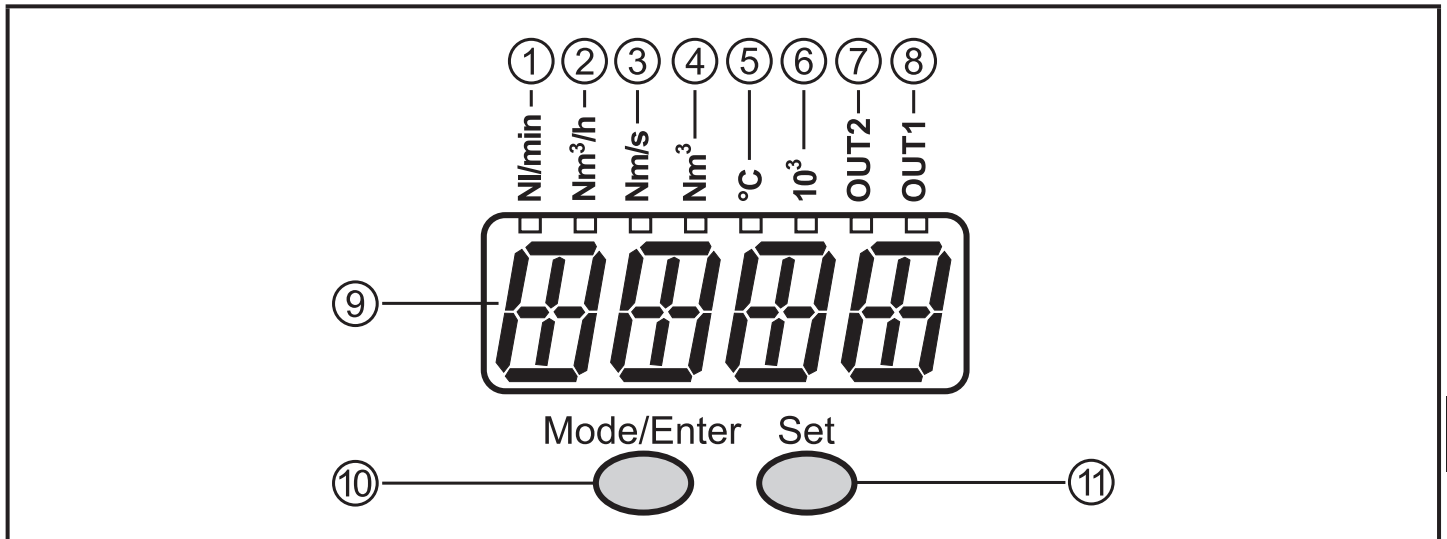

UK

1 to 8: Indicator LEDs

- LEDs 1-6 = unit of the currently represented numerical value → 11.1 Reading the process value
- LED 7 = switching status of output OUT2 / of input InD
- LED 8 = switching status of output OUT1

9: Alphanumeric display, 4 digits

- Current volumetric flow quantity (with setting [SELD] = [FLOW])
- Current flow velocity (with setting [SELD] = [FLOW])
- Meter reading of the totaliser (with setting SELd = TOTL)
- Current medium temperature (with setting SELd = TEMP)
- Parameters and parameter values

10: [Mode/Enter] button

- Selecting the parameters
- Confirming the parameter values

11: [Set] button

- Reading the set parameter values
- Changing the parameter values
- Change to menu level 2
- Change of the display unit in the normal operating mode (Run mode)

8 Menu

8.1 Main menu

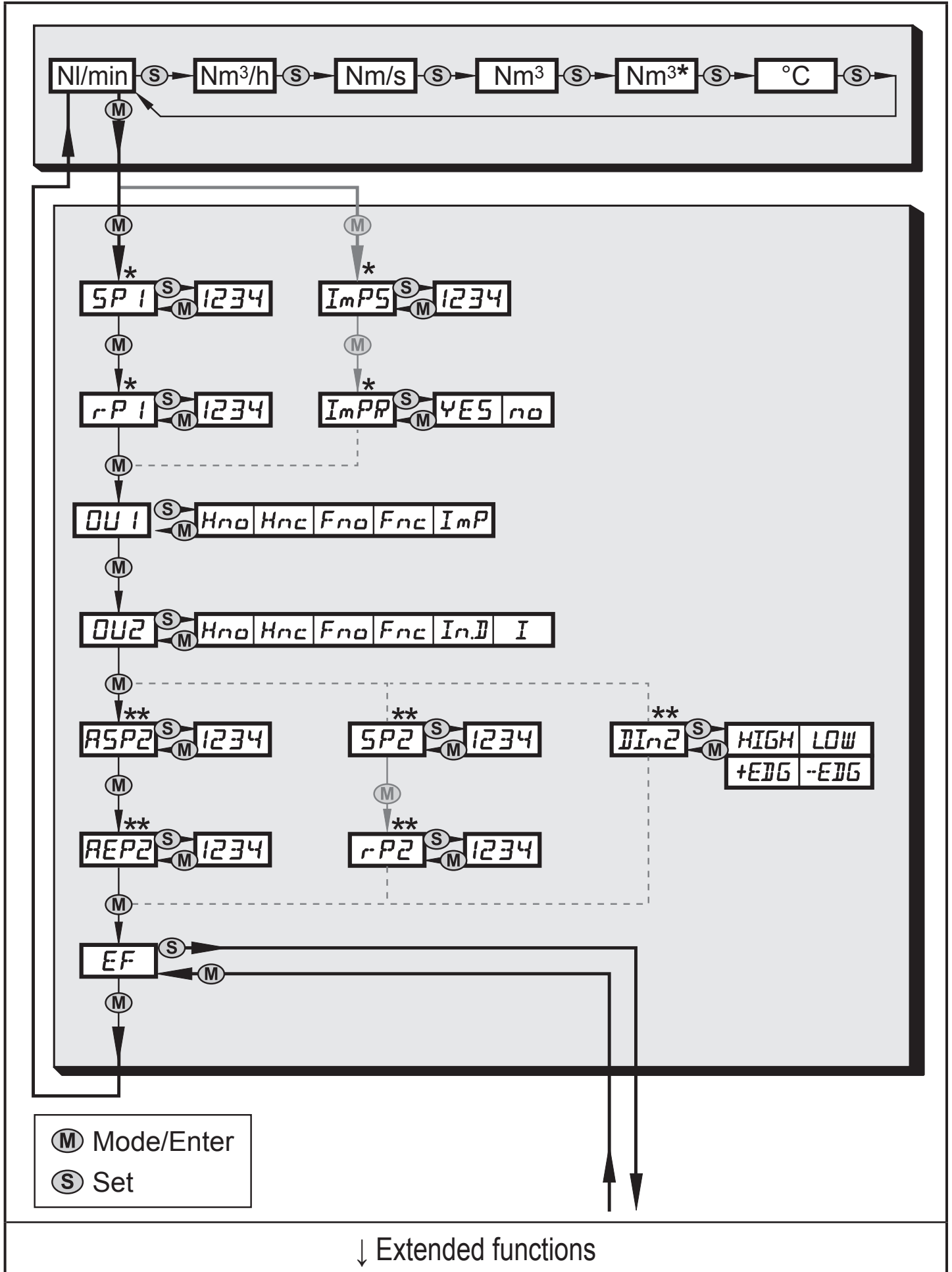

Explanation main menu

SP1 / rP1	Upper / lower limit value for volumetric flow.
ImPS	Pulse value.
ImPR	Pulse repetition active (= pulse output) or not active (= preset counter function).
OU1	Output function for OUT1 (volumetric flow or consumed quantity): - Switching signal for the limit values. - Pulse or switching signal for quantity meter.
OU2	Output function for OUT2 (volumetric flow or temperature): - Switching signal for the limit values. - Analogue signal: 4-20 mA [I].
	As an alternative: configure OUT2 (pin 2) as input for external reset signal: Setting: [OU2] = [InD].
SP2 / rP2	Upper / lower limit value for volumetric flow or temperature.
ASP2 / AEP2	Analogue start value / analogue end value for volumetric flow or temperature.
DIn2	Configure the input (pin 2) for meter reset.
EF	Extended functions / opening of menu level 2.

UK

* The parameters are only displayed when selected at OU1.

** The parameters are only displayed when selected at OU2.

Nm³ = current meter reading in Nm³

Nm^{3*} = stored meter reading in Nm³

8.2 Extended functions

↑ Main menu

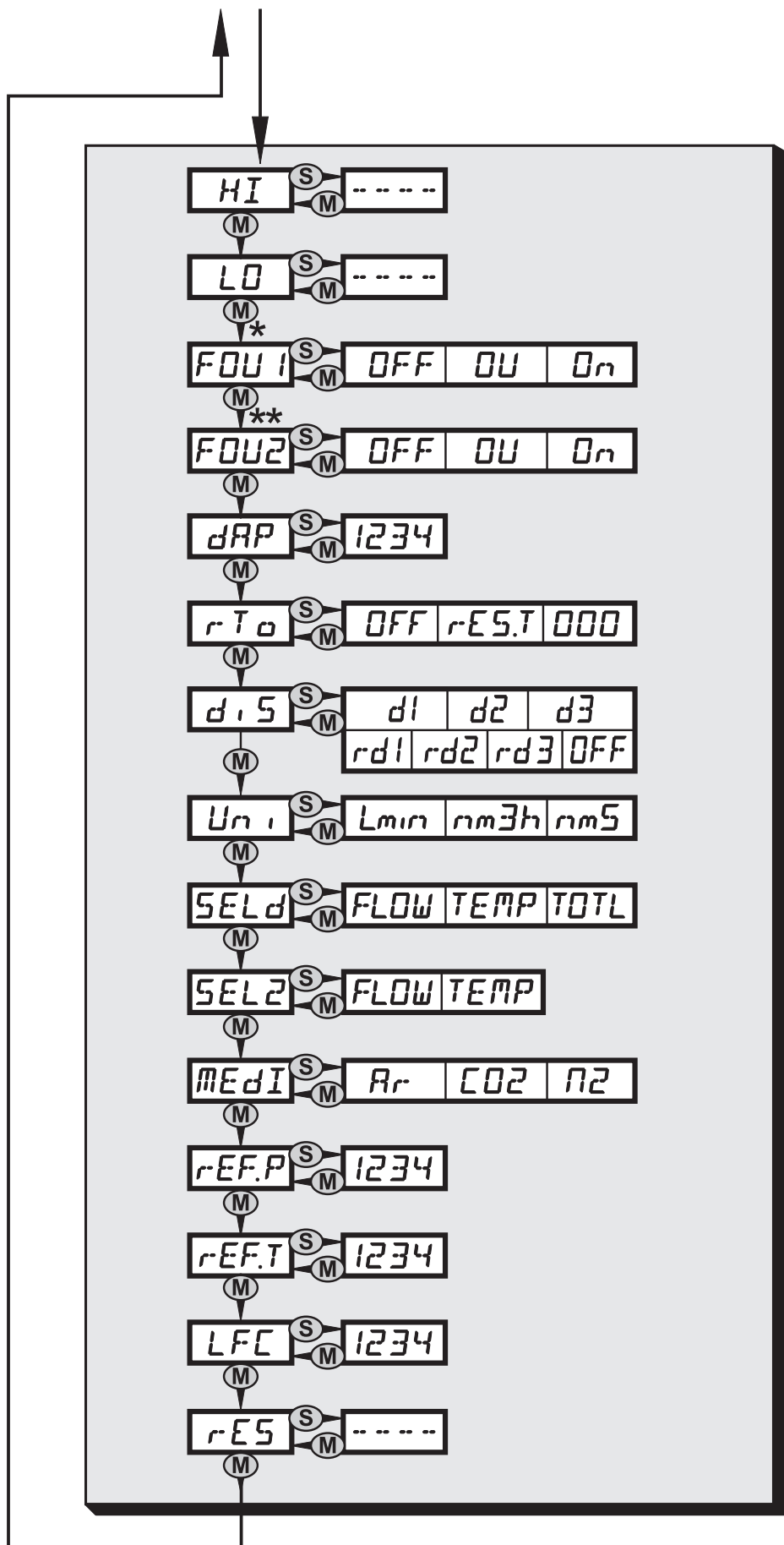

Explanation extended functions

HI / LO	Maximum / minimum value memory for volumetric flow.
FOU1	Status of output 1 in case of an internal fault.
FOU2	Status of output 2 in case of an internal fault.
dAP	Measured value damping / damping constant in seconds.
rTo	Meter reset: manual reset / time-controlled reset.
diS	Update rate and orientation of the display.
Uni	Standard unit of measurement for volumetric flow: NI/min, Nm ³ /h or Nm/s.
SELd	Standard measured variable of the display: volumetric flow value, meter reading or medium temperature.
MEDI	Selection of the medium to be monitored.
SEL2	Standard measured variable for evaluation by OUT2: - limit value signal or analogue signal for volumetric flow. - limit value signal or analogue signal for temperature.
rEF.P	Standard pressure to which the measured and display values for volumetric flow refer.
rEF.T	Standard temperature to which the measured and display values for volumetric flow refer.
LFC	Low flow cut-off.
rES	Restore factory setting.

* The parameters are only displayed when selected at OU1.

** The parameters are only displayed when selected at OU2.

9 Set-up

After power on and expiry of the power-on delay time of approx. 1 s the unit is in the Run mode (= normal operating mode). It carries out its measurement and evaluation functions and generates output signals according to the set parameters.

- During the power-on delay time the outputs are switched as programmed:
 - ON with normally open function (Hno / Fno)
 - OFF with normally closed function (Hnc / Fnc).
- If output 2 is configured as analogue output, the output signal is at 20 mA (current output).

10 Parameter setting



- The selection of an incorrect medium increases the measurement deviation.
- ▶ Set the medium first before using the unit for the first time and setting all the other parameter values (→ 10.6.8 Select the medium to be monitored).

Parameters can be set before installation and set-up of the unit or during operation.



- If you change parameters during operation, this will influence the function of the plant.
- ▶ Ensure that there will be no malfunctions in your plant.

During parameter setting the unit remains in the operating mode (Run mode). It continues to monitor with the existing parameter until the parameter setting has been completed.

10.1 IO-Link

10.1.1 General information

This unit has an IO-Link communication interface which requires an IO-Link-capable module (IO-Link master) for operation.

The IO-Link interface enables direct access to the process and diagnostic data and provides the possibility to set the parameters of the unit during operation.

In addition communication is possible via a point-to-point connection with a USB adapter cable.

You will find more detailed information about IO-Link at www.ifm.com/gb/io-link.

10.1.2 Device-specific information



You will find the IODDs necessary for the configuration of the IO-Link unit and detailed information about process data structure, diagnostic information and parameter addresses at www.ifm.com/gb/io-link.

10.1.3 Parameter setting tools

You will find all necessary information about the required IO-Link hardware and software at www.ifm.com/gb/io-link.

10.2 Parameter setting in general

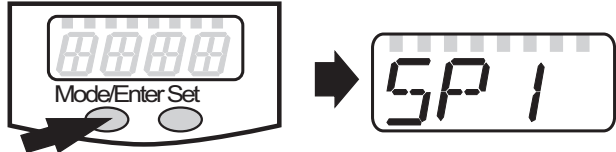
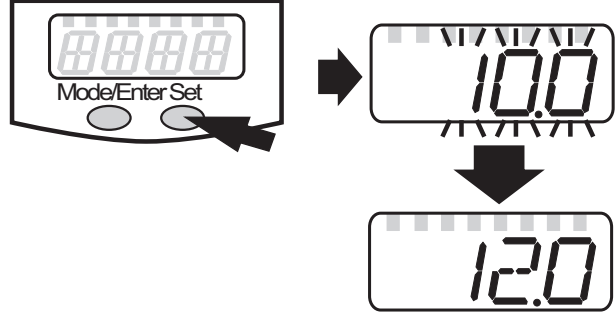
3 steps must be taken for each parameter setting:

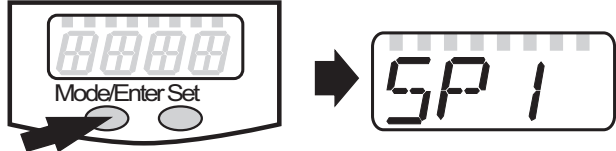
<p>1</p>	<p>Select parameter</p> <ul style="list-style-type: none"> ▶ Press [Mode/Enter] until the requested parameter is displayed. 	
<p>2</p>	<p>Set parameter value</p> <ul style="list-style-type: none"> ▶ Press and hold [Set]. > Current setting value of the parameter flashes for 5 s. > After 5 s: setting value is changed: incrementally by pressing the button once or continuously by keeping the button pressed. 	
<p> Numerical values are incremented continuously. For reducing the value:</p> <ul style="list-style-type: none"> ▶ Let the display move to the maximum setting value. > Then the cycle starts again at the minimum setting value. 		
<p>3</p>	<p>Acknowledge parameter value</p> <ul style="list-style-type: none"> ▶ Briefly press [Mode/Enter]. > The parameter is displayed again. The new setting value is saved. 	
<p>Set other parameters</p> <ul style="list-style-type: none"> ▶ Start again with step 1. 		
<p>Finish parameter setting</p> <ul style="list-style-type: none"> ▶ Press [Mode/Enter] several times until the current measured value is displayed or wait for 15 s (from menu level 1) or 30 s (from menu level 2). > The unit returns to the operating mode. 		

 If [S.Loc] is displayed when an attempt is made to modify a parameter value, either an IO-Link communication is active (temporary locking) or the sensor is permanently locked via software. This locking can only be removed with a parameter setting software.

10.2.1 Change from menu level 1 to menu level 2:

<ul style="list-style-type: none"> ▶ Press [Mode/Enter] until [EF] is displayed. 	
---	--

UK

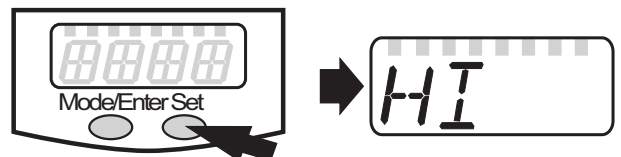
<ul style="list-style-type: none"> ▶ Briefly press [Set]. > The first parameter of the submenu is displayed (here: [HI]). 	
--	---

10.2.2 Locking / unlocking

The unit can be locked electronically to prevent unintentional settings.

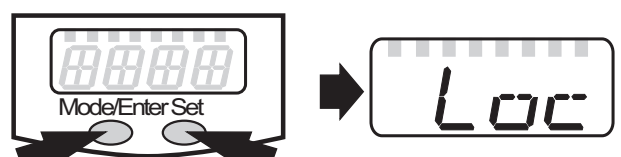
<ul style="list-style-type: none"> ▶ Make sure that the unit is in the normal operating mode. ▶ Press [Mode/Enter] + [Set] for 10 s. > [Loc] is displayed. 	
--	--

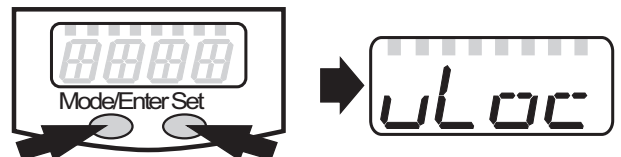

During operation: [LOC] is briefly displayed if you try to change parameter values.

<p>For unlocking:</p> <ul style="list-style-type: none"> ▶ Press [Mode/Enter] + [Set] for 10 s. > [uLoc] is displayed. 	
---	--

On delivery: unlocked

10.2.3 Timeout

If no button is pressed for 15 s during parameter setting, the unit returns to the operating mode with unchanged values.

10.3 Settings for consumed quantity monitoring

10.3.1 Configure limit value monitoring with OUT1

<ul style="list-style-type: none"> ▶ Select [Uni] and set the unit of measurement (→ 10.6.1). ▶ Select [OU1] and set the switching function. <ul style="list-style-type: none"> - [Hno] = hysteresis function/normally open - [Hnc] = hysteresis function/normally closed - [Fno] = window function/normally open - [Fnc] = window function/normally closed ▶ Select [SP1] and set the value at which the output switches. ▶ Select [rP1] and set the value at which the output resets. 	<pre style="font-family: monospace; font-size: 1.2em;"> Uni OU 1 SP 1 rP 1 </pre>
--	---

10.3.2 Configure limit value monitoring with OUT2

<ul style="list-style-type: none"> ▶ Select [Uni] and set the unit of measurement (→ 10.6.1). ▶ Select [SEL2] and set [FLOW]. ▶ Select [OU2] and set the switching function. <ul style="list-style-type: none"> - [Hno] = hysteresis function/normally open - [Hnc] = hysteresis function/normally closed - [Fno] = window function/normally open - [Fnc] = window function/normally closed ▶ Select [SP2] and set the value at which the output switches. ▶ Select [rP2] and set the value at which the output resets. 	<pre>Uni SEL2 OU2 SP2 rP2</pre>
---	---------------------------------

UK

10.3.3 Configure analogue value for volumetric flow

<ul style="list-style-type: none"> ▶ Select [Uni] and set the unit of measurement (→ 10.6.1). ▶ Select [SEL2] and set [FLOW]. ▶ Select [OU2] and set the function. <ul style="list-style-type: none"> - [I] = current signal proportional to volumetric flow (4...20 mA) ▶ Select [ASP] and set the value at which the minimum value is provided. ▶ Select [AEP] and set the value at which the maximum value is provided. 	<pre>Uni SEL2 OU2 ASP AEP</pre>
---	---------------------------------

10.4 Settings for consumed quantity monitoring

10.4.1 Configure quantity monitoring via pulse output

<ul style="list-style-type: none"> ▶ Select [OU1] and set [ImP]. ▶ Select [ImPS] and set the volumetric flow quantity at which 1 pulse is provided (→ 10.4.3). ▶ Select [ImPR] and set [YES]. > Pulse repetition is active. Output 1 provides a counting pulse each time the value set in [ImPS] is reached. 	<pre>OU 1 ImPS ImPR</pre>
---	---------------------------

10.4.2 Configure quantity monitoring via the preset counter

<ul style="list-style-type: none"> ▶ Select [OU1] and set [ImP]. ▶ Select [ImPS] and set the volumetric flow quantity at which output 1 switches (→ 10.4.3). ▶ Select [ImPR] and set [no]. > Pulse repetition is not active. The output switches ON if the value set in [ImPS] is reached. It remains switched until the counter is reset. 	<pre>OU 1 ImPS ImPR</pre>
---	---------------------------

10.4.3 Setting the pulse value

- ▶ Select [ImPS].
- ▶ Press and hold [Set].
- > The current numerical value flashes for 5 s, then one of the 4 digits becomes active and can be changed as below:
 1. Briefly press [Set]
 - > Active figure is changed.
 2. Keep [Set] pressed
 - > The next figure on the left becomes active.
-  - After the cycle of the figures on the left on the display the display changes to the next higher setting range (decimal point shifts or LED changes).
 - Change to the lower setting range: Keep [Set] pressed until the display moves through all ranges and jumps back to the start value.
- 3. Wait without pressing a button
 - > The next figure on the right becomes active.
- ▶ Briefly press [Mode/Enter] when all 4 digits are set.

ImPS

Setting ranges:

LED ¹⁾	Unit	Display	Value	Step increment
4	Nm ³	<i>0.001...9.999</i>	0.001 ... 9.999 Nm ³	0.001 Nm ³
4	Nm ³	<i>10.00...99.99</i>	10...99.99 Nm ³	0.01 Nm ³
4	Nm ³	<i>100.0...999.9</i>	100...999,9 Nm ³	0.1 Nm ³
4	Nm ³	<i>1000...9999</i>	1000...9999 m ³	1 Nm ³
4 + 6	Nm ³ x 10 ³	<i>10.00...99.99</i>	10 000...99 990 Nm ³	10 Nm ³
4 + 6	Nm ³ x 10 ³	<i>100.0...999.9</i>	100 000... 999 900 Nm ³	100 Nm ³
4 + 6 ²⁾	Nm ³ x 10 ³	<i>1000</i>	1 000 000 Nm ³	
4 + 6 ³⁾	Nm ³ x 10 ³	<i>1000...3000</i>	1 000 000... 3 Nm ³	1000 Nm ³

ImPS

¹⁾ Indicator LED → 7 Operating and display elements

²⁾ SD5100; SD6100

³⁾ SD8100

10.4.4 Manual counter reset

<ul style="list-style-type: none">▶ Select [rTo].▶ Press [Set] until [rES.T] is displayed.▶ Briefly press [Mode/Enter]. <p>> The counter is reset to zero.</p>	
---	---

10.4.5 Time-controlled counter-reset

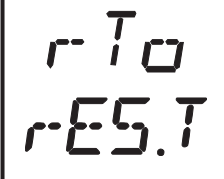

<ul style="list-style-type: none">▶ Select [rTo].▶ Press [Set] until the requested value is displayed (intervals from 1 hour to 8 weeks).▶ Briefly press [Mode/Enter].▶ Press [Set] until [rES.T] is displayed.▶ Briefly press [Mode/Enter]. <p>> The counter is reset automatically with the value now set.</p>	
---	---

UK

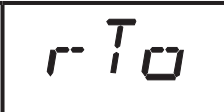
10.4.6 Deactivate meter reset

<ul style="list-style-type: none">▶ Select [rTo] and set [OFF]. <p>> The meter is only reset after overflow (= factory setting). Overflow: After the maximum value the meter is reset to 0.</p>	
--	--

10.4.7 Configure meter reset using an external signal

<ul style="list-style-type: none">▶ Select [OU2] and [InD].▶ Select [Din2] and set the reset signal.<ul style="list-style-type: none">- [HIGH] = reset for high signal- [LOW] = reset for low signal- [+EDG] = reset for rising edge- [-EDG] = reset for falling edge <p> LED 7 (→ 7 Operating and display elements) indicates the input status also with an active external reset.</p>	
---	---

10.5 Settings for temperature monitoring

10.5.1 Configure limit value monitoring with OUT2

<ul style="list-style-type: none">▶ Select [SEL2] and set [TEMP].▶ Select [OU2] and set the switching function.<ul style="list-style-type: none">- [Hno] = hysteresis function/normally open- [Hnc] = hysteresis function/normally closed- [Fno] = window function/normally open- [Fnc] = window function/normally closed▶ Select [SP2] and set the value at which the output switches.▶ Select [rP2] and set the value at which the output resets.	<pre>SEL2 OU2 SP2 rP2</pre>
---	-----------------------------

10.5.2 Configure analogue value for temperature

<ul style="list-style-type: none">▶ Select [SEL2] and set [TEMP].▶ Select [OU2] and set the function.<ul style="list-style-type: none">- [I] = temperature-proportional current signal (4...20 mA)▶ Select [ASP] and set the value at which the minimum value is provided.▶ Select [AEP] and set the value at which the maximum value is provided.	<pre>SEL2 OU2 ASP AEP</pre>
---	-----------------------------

10.6 User settings (optional)

10.6.1 Set standard unit of measurement for volumetric flow

<ul style="list-style-type: none">▶ Select [Uni] and set the unit of measurement: [Lmin] or [m3h] or [nmS]. <div style="display: flex; align-items: flex-start;"><div style="margin-right: 10px;"></div><div><p>The setting only has an effect on the volumetric flow value. The counter values (consumed quantity) are automatically displayed in the unit of measurement providing the highest accuracy.</p></div></div>	<pre>Uni</pre>
--	----------------

10.6.2 Configuration of the standard display

<ul style="list-style-type: none"> ▶ Select [SELd] and determine the standard measuring unit. <ul style="list-style-type: none"> - [FLOW] = the current volumetric flow value in the standard unit of measurement is displayed - [TOTL] = the current meter reading in Nm or 1000 Nm³ - [TEMP] = the current medium temperature in °C is displayed ▶ Select [diS] and set the update rate and orientation of the display. <ul style="list-style-type: none"> - [d1] = update of the measured values every 50 ms - [d2] = update of the measured values every 200 ms - [d3] = update of the measured values every 600 ms - [rd1], [rd2], [rd3] = display as for d1, d2, d3; rotated by 180° - [OFF] = the display is switched off in the operating mode; when pressing the button the process value is displayed for 15 s. 	
--	---

UK

10.6.3 Set measured value damping

<ul style="list-style-type: none"> ▶ Select [dAP] and set the damping constant in seconds (τ value 63 %). 	
--	---

10.6.4 Set output status in fault condition

<ul style="list-style-type: none"> ▶ Select [FOU1] and set the value <ul style="list-style-type: none"> - [On] = output 1 switches ON in case of an error. - [OFF] = output 1 switches OFF in case of an error. > For both values ([ON] and [OFF]) the counter stops counting in case of a fault. <ul style="list-style-type: none"> - [OU] = output 1 switches irrespective of the fault as defined with the parameters. ▶ Select [FOU2] and set the value <ul style="list-style-type: none"> - [On] = output 2 switches ON in case of a fault, the analogue signal goes to the upper end stop value (22 mA). - [OFF] = output 2 switches OFF in case of a fault, the analogue signal goes to the lower end stop value (3.5 mA). - [OU] = output 2 switches irrespective of the fault as defined with the parameters. The curve of the analogue signal corresponds to IEC60947-5-7 (→ diagram in → 4.6). 	
--	---

10.6.5 Set standard pressure

<ul style="list-style-type: none"> ▶ Select [rEF.P] and set the requested standard pressure. Setting range: 950...1050 hPa in steps of 1 hPa. 	
--	---

10.6.6 Set standard temperature

<p>▶ Select [rEF.T] and set the requested standard temperature. Setting range: 0...25 °C in steps of 1 °C.</p>	r-EF.T
--	--------

10.6.7 Set low flow cut-off

<p>▶ Select [LFC] and set the limit value. Setting range: 0.1...0.8 Nm³/h in steps of 0.1 Nm³/h.</p>	LFC
--	-----

10.6.8 Select the medium to be monitored

<p>▶ Select [MEDI] and set the requested medium:</p> <ul style="list-style-type: none">- [Ar] = argon.- [CO2] = carbon dioxide.- [N2] = nitrogen. <p> Changing to another medium modifies the set limit values for switching signals and the analogue signal.</p> <ul style="list-style-type: none">▶ Select the medium before setting the values for SPx, rPx, ASP und AEP.	MEDI
--	------

10.7 Service functions

10.7.1 Read min/max values for volumetric flow

<p>▶ Select [HI] or [Lo], briefly press [Set]. [HI] = maximum value, [Lo] = minimum value</p> <p>Delete memory</p> <ul style="list-style-type: none">▶ Select [HI] or [Lo].▶ Press and hold [Set] until [----] is displayed.▶ Briefly press [Mode/Enter]. <p>It makes sense to delete the memories as soon as the unit operates under normal operating conditions for the first time.</p>	HI LO
---	----------

10.7.2 Reset all parameters to factory setting

<p>▶ Select [rES].</p> <ul style="list-style-type: none">▶ Press and hold [Set] until [----] is displayed.▶ Briefly press [Mode/Enter]. <p>For the factory settings please refer to the end of these instructions (→ 13). We recommend taking down your own settings in that table before carrying out a reset.</p> <p> After reset to factory setting the value of the memory is at zero.</p>	r-ES
---	------

11 Operation

11.1 Reading the process value

The LEDs 1-6 signal which process value is currently displayed.

The process value to be displayed as standard (temperature, flow velocity or meter reading of the totaliser) can be preset → 10.6.2 Configuration of the standard display).

A standard unit of measurement can be defined for the flow velocity (Nl/min or Nm³/h or Nm/s → 10.6.1).

11.2 Change display unit in the Run mode

- ▶ Briefly press [Set] in the Run mode. Press the button to move to the next display unit.
- > The unit displays the current process value in the selected display unit for approx. 15 s, the corresponding LED is lit.

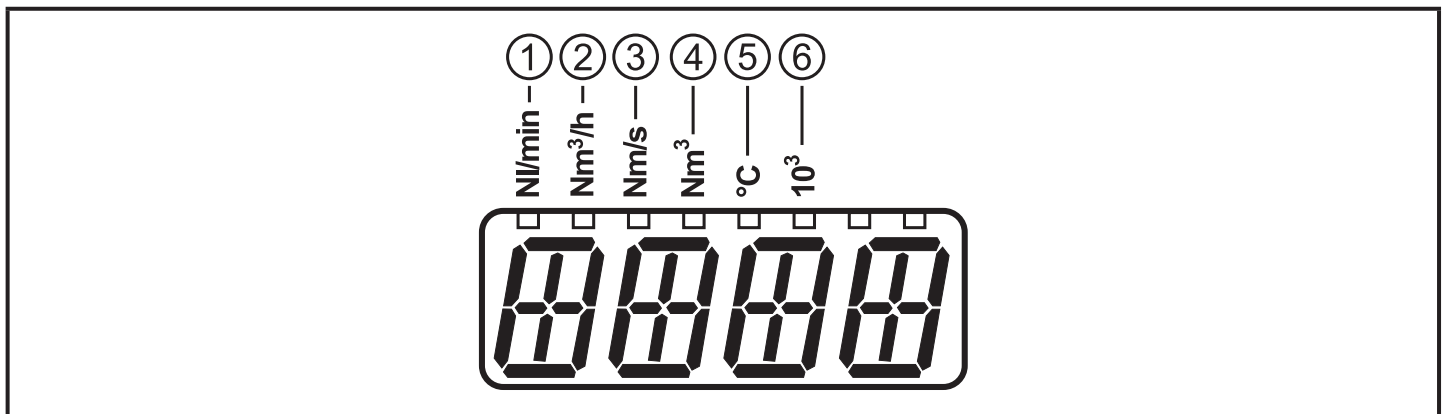

LED	Process value display	Unit
1 <input type="checkbox"/>	Current flow volume per minute	Nl/min
2 <input type="checkbox"/>	Current flow volume per hour	Nm ³ /h
3 <input type="checkbox"/>	Current flow velocity	Nm/s
4 <input type="checkbox"/>	Totaliser*	Current consumed quantity since the last reset
4 <input type="checkbox"/>		Consumed quantity before the last reset
4 + 6 <input type="checkbox"/>		Current consumed quantity since the last reset
4 + 6 <input type="checkbox"/>		Consumed quantity before the last reset
5 <input type="checkbox"/>	Current medium temperature	°C

LED is lit; LED flashes

11.3 Read set parameters

- ▶ Press [Mode/Enter] until the requested parameter is displayed.
- ▶ Briefly press [Set].
- > The unit displays the corresponding parameter value.
- > After about 15 s (from menu level 1) or 30 s (from menu level 2) it again displays the parameter, then it returns to the Run mode.

11.4 Fault indications

[SC1]	Short circuit in OUT1*
[SC2]	Short circuit in OUT2*
[SC]	Short circuit in both outputs*
[OL]	Measured value > 120 % of the final value of the measuring range
[UL]	Measured value < -20 % of the final value of the measuring range (temperature)
[Err]	Flashing: error in the measuring probe or measured value > 130 % of the final value of the measuring range

*The output concerned is switched off as long as the short circuit exists.
These messages are displayed even if the display is switched off.

11.5 General operating conditions

The unit is maintenance-free for media which do not stick to the measuring probes.

- From time to time check the measuring probes visually for build-up.
- If necessary, clean them at regular intervals. To do so, use a suitable cleaning liquid (e.g. alcoholic solution).
- Avoid mechanical damage to the measuring probes.

12 Technical data and scale drawing

Technical data and scale drawing at www.ifm.com.

13 Factory setting

	Factory setting	User setting
SP1	20 % *	
rP1	19.5 % *	
ImPS	0.001	
ImPR	YES	
OU1	Hno	
OU2	I	
SP2	40 % *	
rP2	39.5 % *	
ASP2	0 % *	
AEP2	100 % *	
FOU1	OFF	
FOU2	OFF	
dAP	0.6	
rTo	OFF	
diS	d3	
Uni	nm3h	
SELd	FLOW	
SEL2	FLOW	
rEF.P	1013hPa	
rEF.T	15 °C	
LFC	0.25 % *	
MEDI	CO2	

* of the final value of the measuring range