

Device manual
Vibration sensor
with IO-Link interface

GB

VV

80298004/01 06/2021

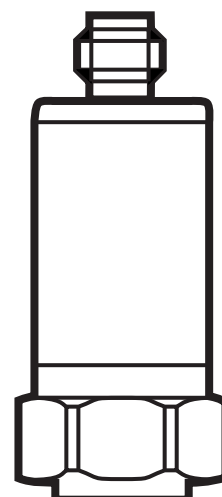



Contents

1	Preliminary note	3
1.1	Explanation of symbols	3
2	Safety instructions	3
3	Functions and features	4
3.1	Product overview	4
4	Installation	5
4.1	Prepare contact surface	6
4.2	Types of mounting	6
4.2.1	Screw	6
4.2.2	Glue	6
4.2.3	Magnet	7
5	Electrical connection	7
6	Function	7
6.1	IO-Link	7
6.2	Switching function	8
6.3	Process data description	9
6.3.1	v-RMS	9
6.3.2	a-RMS	9
6.3.3	a-Peak	10
6.3.4	Crest factor	10
6.4	Event counter, event history and operating hours counter	10
6.5	Machine monitoring	10
6.6	Marking	10
7	Parameter setting	11
7.1	Parameters	12
7.2	Reading of raw data (BLOB)	14
7.3	Application examples for filter setting and signal evaluation	15
7.3.1	Filter a - evaluation of the signal components between 2...1000 Hz	15
7.3.2	Filter a - evaluation of the signal components > 3000 Hz	16
7.3.3	Filter a - evaluation of the signal components > 10 Hz	16
7.3.4	Filter v - evaluation of the signal components between 2...1000 Hz	17
7.3.5	Filter v - evaluation of the signal components between 10...1000 Hz	17
8	Maintenance, repair and disposal	18
9	Factory setting	18
9.1	General configuration	18
9.2	Specific configuration	18

1 Preliminary note

Technical data, approvals, accessories and further information at www.ifm.com.

1.1 Explanation of symbols

- ▶ Instructions
- > Reaction, result
- Cross-reference
-  Important note
Non-compliance may result in malfunction or interference.
-  Information
Supplementary note

2 Safety instructions

- The device described is a subcomponent for integration into a system.
 - The system architect is responsible for the safety of the system.
 - The system architect undertakes to perform a risk assessment and to create documentation in accordance with legal and normative requirements to be provided to the operator and user of the system. This documentation must contain all necessary information and safety instructions for the operator, the user and, if applicable, for any service personnel authorised by the architect of the system.
- Read this document before setting up the product and keep it during the entire service life.
- The product must be suitable for the corresponding applications and environmental conditions without any restrictions.
- Only use the product for its intended purpose(→ 3 Bestimmungsgemäße Verwendung).
- If the operating instructions or the technical data are not adhered to, personal injury and/or damage to property may occur.
- The manufacturer assumes no liability or warranty for any consequences caused by tampering with the product or incorrect use by the operator.
- Installation, electrical connection, set-up, programming, configuration, operation and maintenance of the product must be carried out by personnel qualified and authorised for the respective activity.
- Protect units and cables against damage.

3 Functions and features

- Condition monitoring on machines and installations (vibration and temperature)
- Parameter setting and process value transmission via the IO-Link interface
- Asynchronous reading of raw data (BLOB - Binary Large Object)

3.1 Product overview

Order number	Type
VVB001	Industrial machines
VVB010	Large-sized machines Performance: > 300 kW, speed: > 600 rpm
VVB011	Large-sized machines Performance: > 300 kW, speed: 120 rpm to < 600 rpm
VVB020	Small machines Performance: < 300 kW, speed: > 600 rpm
VVB021	Small machines Performance: < 300 kW, speed: 120 rpm to < 600 rpm



Each product is offered in two software versions (status A and status B). The IO-Link interface descriptions of both software versions are available at www.ifm.com.



When setting up a new VV unit with COM3, software status B is automatically used. The unit is downward compatible with software status A.

A VV unit with COM2 can be used with software status B. In this case, only the functionalities of status A will be available.



If VV units with software status B are operated with a PLC, they transmit output process data and read input process data.

The unit is rejected unless the PLC module is set to "Device identification".

For the unit to be recognised, either

- change the port in the PLC to software status B subsequently (see IO-Link interface description)
- or activate "Device identification" in the PLC subsequently.

4 Installation

- ▶ Screw the threaded adapter 1/4"-28 UNF / M8 (2) or the threaded adapter 1/4"-28 UNF (3) into the unit (1). Threaded adapters are supplied.
- ▶ Tighten using a 3 mm Allen key. Tightening torque 8 Nm.
- ▶ Drill and tap a hole at the mounting location:
- ▶ M8 hole / depth min. 10 mm for threaded adapter 1/4"-28 UNF/ M8.
- ▶ Or 1/4"-UNF hole / depth min. 13 mm for threaded adapter 1/4"-28 UNF.

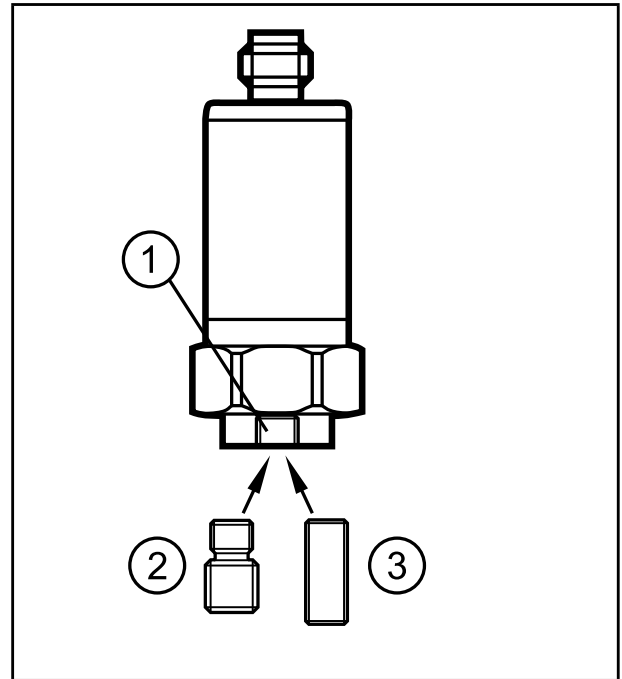

The measuring direction should be in the direction of the main vibration. The main vibration is usually in radial direction to the shaft.

In case of fixed bearings with high axial force absorption or axial bearings, the recommended measuring direction is axial to the shaft.

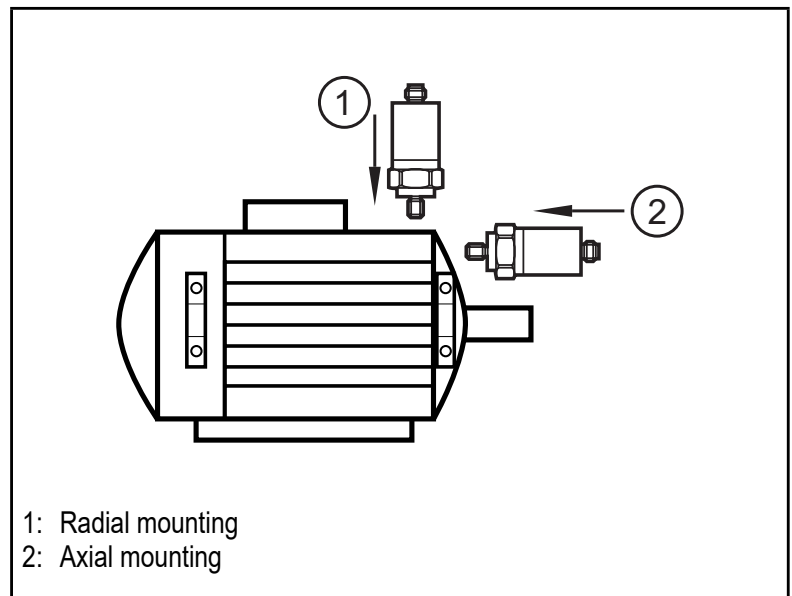

- ▶ Mount only in a thick housing wall and vertically to the machine surface close to the bearing or at the end shield.
- ▶ Note the measuring direction of the sensor.
- ▶ Ensure a safe vibration transmission and allow no elastic intermediate layers.
- ▶ Tighten the unit with a tightening torque of 8 Nm.

Adapters of any kind have an impact on the vibration measurement. The mass, shape and stiffness of the adapter have an influence on the frequency response of the entire system. Both resonances and damping effects may occur in different frequency ranges.

- ▶ For all installation types, tighten the sensor with the tightening torque indicated in the data sheet.

 To measure the process value temperature, a safe mechanical connection of the sensor must be ensured.

- ▶ Ensure proper installation.

 A tightening torque that is too low may lead to insufficient coupling between the sensor and the machine whereas a tightening torque that is too high may damage the sensor and the screw.

4.1 Prepare contact surface

- ▶ Prepare a clean and smooth contact surface that is free from any coating to fix the sensor.

The prepared contact surface must be a little larger than the sensor or the mounting adapter.

4.2 Types of mounting

The following table indicates the transferable measuring range of 3 different types of mounting.

Type of mounting	Frequency range
Screw	Up to approx. 15 kHz
Direct gluing	Up to approx. 8 kHz
Magnet	Up to approx. 3 kHz

4.2.1 Screw

For the permanent installation of sensors, a screw connection is the ideal and recommended method.

- ▶ Screw sensor.
- ▶ Increase the stiffness of the connection using screw retaining compound.

4.2.2 Glue

Gluing is suitable for temporary measurements or if the surface is not suitable for a screw connection.

- ▶ Use an adhesive adapter so that the sensor can be replaced.
- ▶ Fix the sensor on the adhesive adapter.
- ▶ Fix the adapter-sensor unit to the machine according to the instructions of the glue used.
- ▶ Apply the adhesive layer as thinly as possible.

 In general, methyl-cyanoacrylate adhesives (e.g. Loctite 454) or epoxy adhesives (e.g. Loctite EA 3450) are used.



When choosing a suitable adhesive always take the materials and the environmental conditions (e.g. temperature range) into account.

4.2.3 Magnet

Using magnets is only recommended for temporary measurements and is only suitable for magnetic surfaces.

- ▶ Fix the sensor on the magnet.
- ▶ Carefully fix the magnet-sensor unit to the machine.



Careless fixing can result in very high g-forces which may damage the sensor.

5 Electrical connection



The unit must be connected by a qualified electrician. The national and international regulations for the installation of electrical equipment must be adhered to.

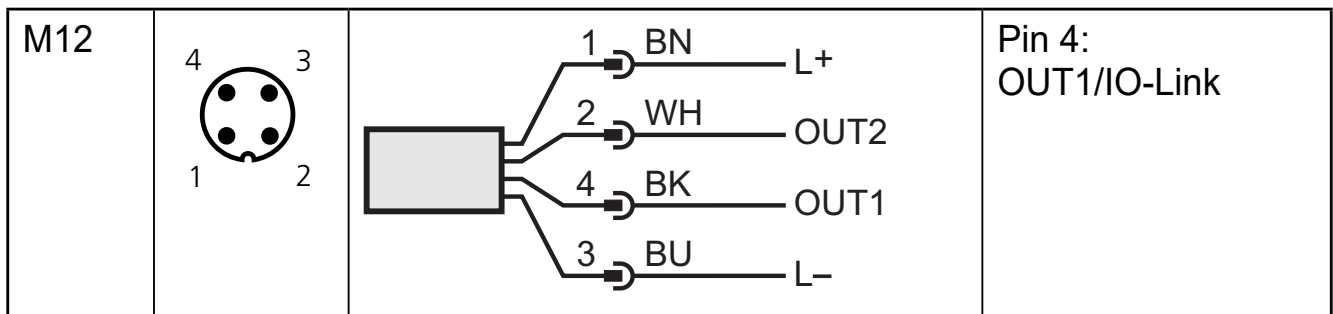

6 Function

6.1 IO-Link

This unit has an IO-Link communication interface which enables direct access to process and diagnostic data. In addition, it is possible to set the parameters of the unit while it is in operation. Operation of the unit via the IO-Link interface requires an IO-Link master.

With a PC, suitable IO-Link software and an IO-Link adapter cable, communication is possible while the system is not in operation.

The IODDs necessary for the configuration of the unit, detailed information about the two IO-Link interface descriptions (status A / status B), process data structure, diagnostic information, parameter addresses and the necessary information about the required IO-Link hardware and software can be found at www.ifm.com.

The IO-Link interface provides additional functions using suitable hardware and software. Different functions are available depending on the software status used.

VV units with status A provide the following additional functions:

- Remote parameter setting of the unit
- Noise-immune signal transmission without measured value losses
- Transmission of the parameter settings to a replaced sensor or to other sensors of the same type
- Simultaneous reading of all process values and the binary switching signals
- Comprehensive display of error and event messages
- Evaluation of the process values and diagnostic data via IO-Link master
- Paperless logging of parameter sets, process values and diagnostic information
- Asynchronous reading of raw data (BLOB) via the BLOB-ID

VV units with status B provide the following additional functions:

- Raw data recording (BLOB) via the BLOB-ID, via system commands, events at switching output 1 or PdOut
- Integrated event counter with history
- Operating time recording (mot) and operating time counter of the machine (mrc) based on the v-RMS value
- Integrated counter of the switch-on operations of the unit
- Integrated device operating hours counter
- Marking of the unit with system-specific, site-specific and function-specific information and entry of the installation date

6.2 Switching function

The switching output O_{Ux} changes its switching status if the value is below or above the set switching limits. Hysteresis or window function can be selected.

Adjustable switching limits of VV units with status A

- v-RMS
- a-Peak
- a-RMS

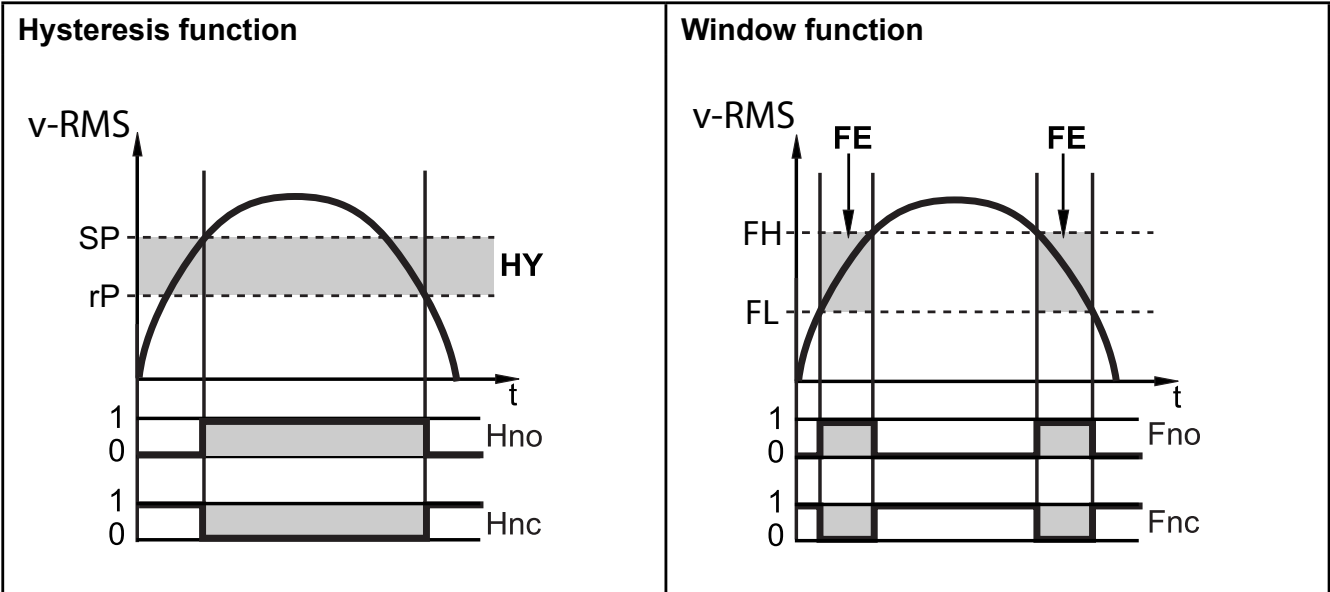

Adjustable switching limits of VV units with status B

- v-RMS
- a-Peak
- a-RMS
- crest
- temperature



SP = set point
 rP = reset point
 HY = hysteresis
 Hno = hysteresis NO (normally open)
 Hnc = hysteresis NC (normally closed)

FH = upper limit
 FL = lower limit
 FE = window
 Fno = window NO (normally open)
 Fnc = window NC (normally closed)

-  For both switching outputs, a switch-on and switch-off delay can be set.
-  For VV units with status B, the two switching outputs (OU1 or OU2) can optionally be set to inactive.

6.3 Process data description

6.3.1 v-RMS

The v-RMS (effective value of the vibration velocity) measures the total load of a rotating machine. The most frequent types of overload (unbalance, alignment errors, etc.) are reflected in the v-RMS. An increased load can damage the machine in the long term (fatigue, fatigue strength) or, in extreme cases, destroy it within a short time.

6.3.2 a-RMS

The a-RMS (effective value of the acceleration) detects mechanical contact of machine components. This contact typically occurs in case of wear (faulty bearing, worn out toothed wheels, etc.) or problems with lubricants (contaminated grease, water in oil, etc.).

6.3.3 a-Peak

The a-Peak monitors the maximum value of the acceleration. Shocks in the acceleration can occur once or periodically, as in a crash, for example in the event of bearing damage. a-Peak is a measure for the forces occurring on the machine.

6.3.4 Crest factor

The crest factor is a described characteristic value of the signal analysis. It is defined as the ratio of the maximum value to the effective value (peak/RMS). In condition monitoring the characteristic value is used for the evaluation of the bearing condition. The high-frequency signals with a short pulse duration of a bearing damage generate higher peak values in relation to the effective value. This relation can be read from the crest factor.

6.4 Event counter, event history and operating hours counter

VV units with status B offer

- an event history with a list of the 20 most recent events. They are stored in an internal ring memory.
- an event counter that can count different events. The event counter is incremented by 1 if the corresponding event occurs.
- an operating hours counter that counts the unit's operating hours since delivery. The internal memory is persistent and cannot be reset.



The event history and the event counter can be reset via system commands.

6.5 Machine monitoring

VV units with status B record the machine's uptime and switch-on operations via the process value v-RMS.

The threshold value for the operating time (mrcT) must be set.

If the set threshold value is exceeded, the operating time counter (mrc) is incremented by 1 and the operating time (mot) is increased by the exceeded time (in seconds).

6.6 Marking

- Application specific tag
Freely definable text, assign to the device
- Function tag
Freely definable text, describes the device function in the plant
- Location tag
Freely definable text, describes the installation location in the plant

- Date of installation
Entry of an installation date. After a unit replacement, the date is not restored.

7 Parameter setting

The parameters can be set before installation and set-up of the unit or during operation via the IO-Link interface.

GB



If you change parameters during operation, this will influence the function of the plant.

- ▶ Ensure that there will be no malfunctions in your plant.

During parameter setting the unit remains in the operating mode. It continues to monitor with the existing parameter until the parameter setting has been completed.

- ▶ Connect the unit to a parameter setting software via suitable hardware.
- ▶ Set the parameters.

The following screenshot is from the ifm parameter setting software moneo Configure

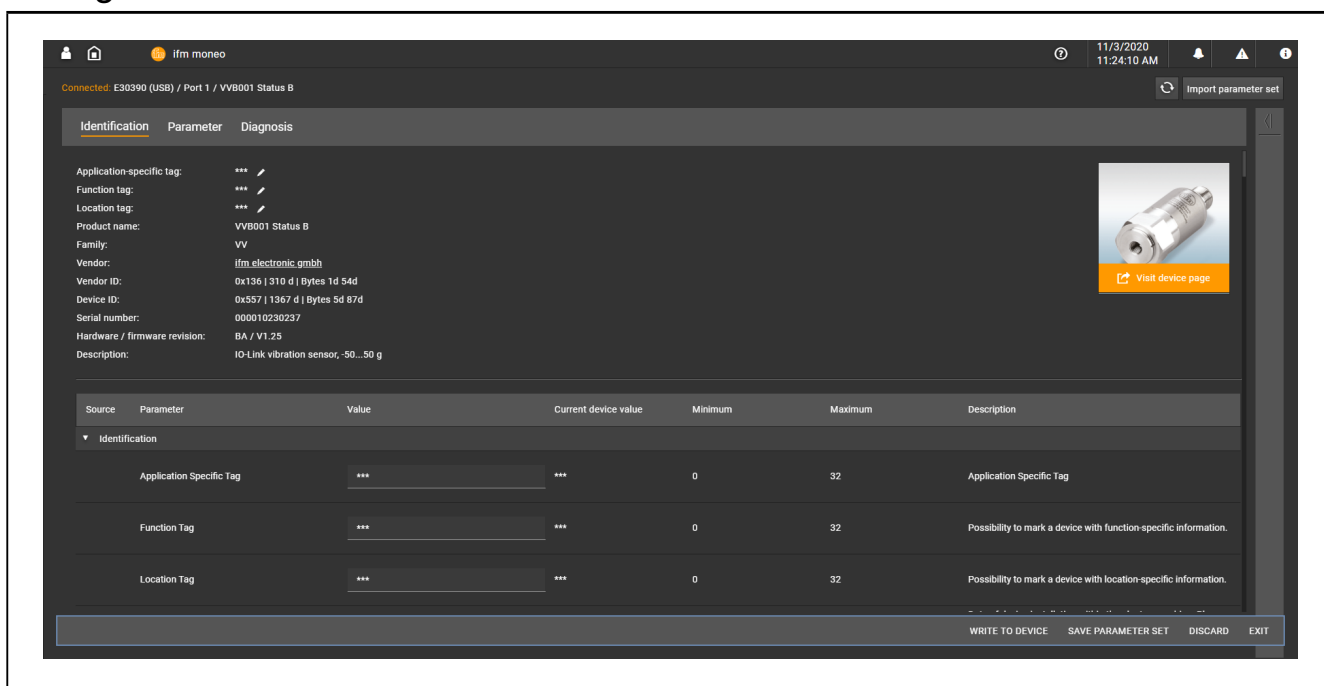

7.1 Parameters



The following IO-Link parameters merely provide an overview of software status B.

A complete list can be found in the IO-Link Data Sheet (IODD) of the unit. The parameters of software status A differ from status B.

Parameter	Description	Setting range
Identification		
Application specific tag	Free text fields, maximum 32 characters per field	
Function tag		
Location tag		
Date of installation	Installation date of the unit in the plant. This parameter is not restored after a device replacement. Enter a new installation date after replacing the unit. Setting range: yyyy-mm-dd	
Parameter		
Output configuration		
ou1 ou2	Switching characteristics hysteresis / window function	Hno / Hnc / Fno / Fnc / OFF
SEL1 SEL2	Process value that is evaluated at the switching output	v-RMS / a-Peak / a-RMS / temperature / crest
P-n	Output function	PNP / NPN
Digital output 1/2	Switch-on delay dS1/2 Switch-off delay dr1/2	0...50 s 0...50 s
Temperature	Temperature Set the set point SP1/2 Set the reset point rP1/2	-28...80 °C -30...78 °C
v-RMS	(Component) fatigue Set the set point SP1/2 Set the reset point rP1/2	0.0002... 0.0450 m/s 0.0000... 0.0448 m/s
a-Peak	Impact Set the set point SP1/2 Set the reset point rP1/2	2.0...490.3 m/s ² 0.0...488.3 m/s ²
a-RMS	Friction Set the set point SP1/2 Set the reset point rP1/2	2.0...490.3 m/s ² 0.0...488.3 m/s ²
Crest	Set the set point SP1/2 Set the reset point rP1	20...500 10...490
Memory		
Temperature	Saves and displays the minimum (Lo.T) and maximum (Hi.T) temperature value	-30.0...80.0 °C

Parameter	Description	Setting range
v-RMS	Saves and displays the maximum value	0.0000...0.0495 m/s
a-Peak		0.0...490.3 m/s ²
a-RMS		0.0...490.3 m/s ²
Crest		1.0...50.0
Standard command	Reset command for saved values	
Signal	Different filters for the internal signal processing	
Filter DC	High-pass Filter for the DC component (static acceleration) - for the calculation of all characteristic values	2 / 10 Hz
Filter A	Bypass / high-pass / low-pass filter for characteristic acceleration values	1 / 3 / 5 kHz
Filter V	Low-pass Filter for the characteristic vibration velocity values	1 kHz
Error configuration		
Output 1-2		
FOU1...2	Output behaviour in case of an error	OFF ON OU (output behaviour is only determined by the process value)
Display setting		
uni - v-RMS	Set physical unit	m/s; mm/s; inch/s
uni - a-Peak, a-RMS		m/s ² ; g; mg
uni.T		°C; °F
Basic settings		
Standard command	Restore factory settings	
Standard command	Start self-test	
Self-test result	Loading of results	
MDC	Loading of results	
BLOB ID	ID of the BLOB just sent	
Diagnostics		
Device status	Displays the current device and diagnostic status	
Event history	Displays a list of the last 20 events	
Event counter	Increments how often the respective event has occurred	

Parameter	Description	Setting range
Machine monitoring	Display of the machine operating time (mot) and display of the number of times the threshold value (mrc) is exceeded based on the process value v-RMS	
Switch-on operations	Number of switch-on operations of the sensor since delivery	
Operating hours counter	Operating hours counter of the sensor since delivery	
Internal temperature	Output of the internal temperature of the sensor by index	
File transfer (BLOB)	Transfer of binary file	

7.2 Reading of raw data (BLOB)

A raw data block of the sensor can be read via the IO-Link BLOB mechanism. This raw data block has a recording length of 4 seconds with a sampling rate of 25 kHz. The individual samples have a bit width of 16 bits and the signed integer format. This results in a total size of the BLOB data set of 200000 bytes.

A raw data block can be recorded by means of 4 different mechanisms:

1. Recording via BLOB ID

For VV units with status A and status B, raw data can be recorded via the BLOB ID. (-4096)

2. Triggered recording via a system command

For VV units with status B, raw data can be recorded via a system command. This raw data can be accessed via the BLOB ID (-4097). If no system command has been sent before the query, 0 bytes of data are transmitted.

3. Event-based recording



VV units with status B have an internal mechanism that is coupled to switching output 1.

If an event occurs at switching output 1, the raw data is recorded. This raw data can be accessed via the BLOB ID (-4098). If no switching event has taken place before the query, 0 bytes of data are transmitted.

4. Triggered recording via PdOut

VV units with status B can record raw data via a bit (no. 4) in the PdOut data flow. Raw data can be recorded via a rising edge of the corresponding bit with valid PdOut data. This raw data can be accessed via the BLOB ID (-4099). If no PdOut trigger has been set before the query, 0 bytes of data are transmitted.

The raw data block is recorded and transmitted from the start moment of the BLOB mechanism. The transmission takes at least 7 minutes depending on the cycle time of the master and the use of COM2 or COM3. Raw data transmission with COM3 takes approx. 2 minutes.

-  To obtain samples scaled to "1g" the data needs to be divided by a scaling factor of $2^{16}/125 = 524.288$ (manual calculation required).
-  VV units with status B provide a memory area for raw data recording regardless of the recording method. This memory is always filled with the last event and the existing memory is overwritten.
-  The raw data is transmitted in binary format and saved as a *.bin file. The raw data can be imported and analysed in the parameter setting software VES004 (> version 2.07.00).

7.3 Application examples for filter setting and signal evaluation

7.3.1 Filter a - evaluation of the signal components between 2...1000 Hz

Settings
DC filter: 2 Hz, high-pass
a filter: 1 kHz, low-pass

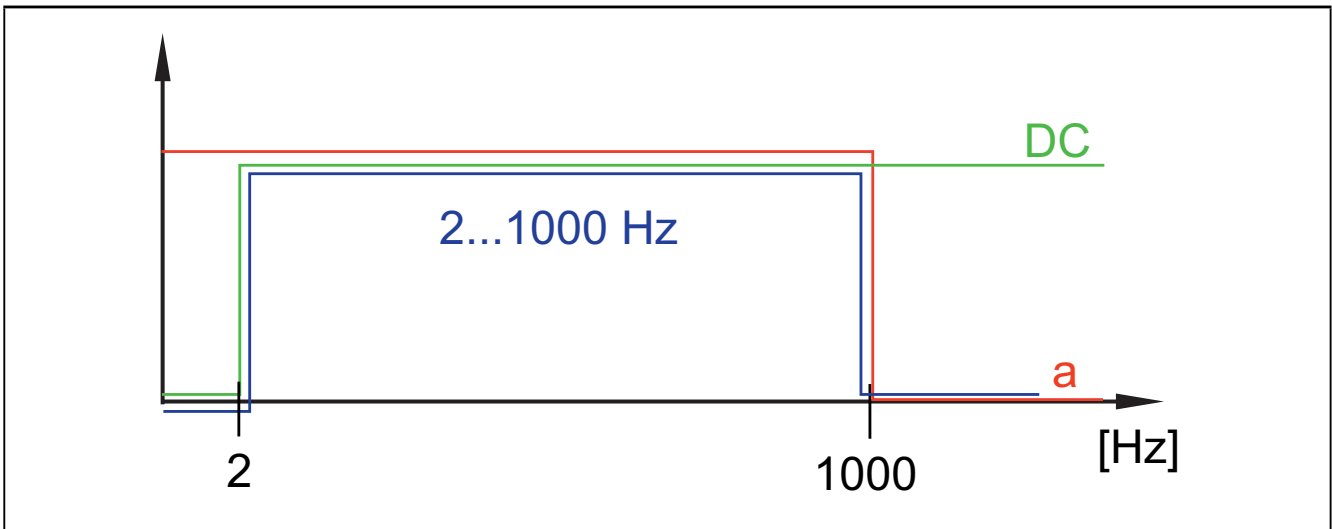

7.3.2 Filter a - evaluation of the signal components > 3000 Hz

Settings

DC filter: 2 Hz, high-pass

a filter: 3 kHz, high-pass

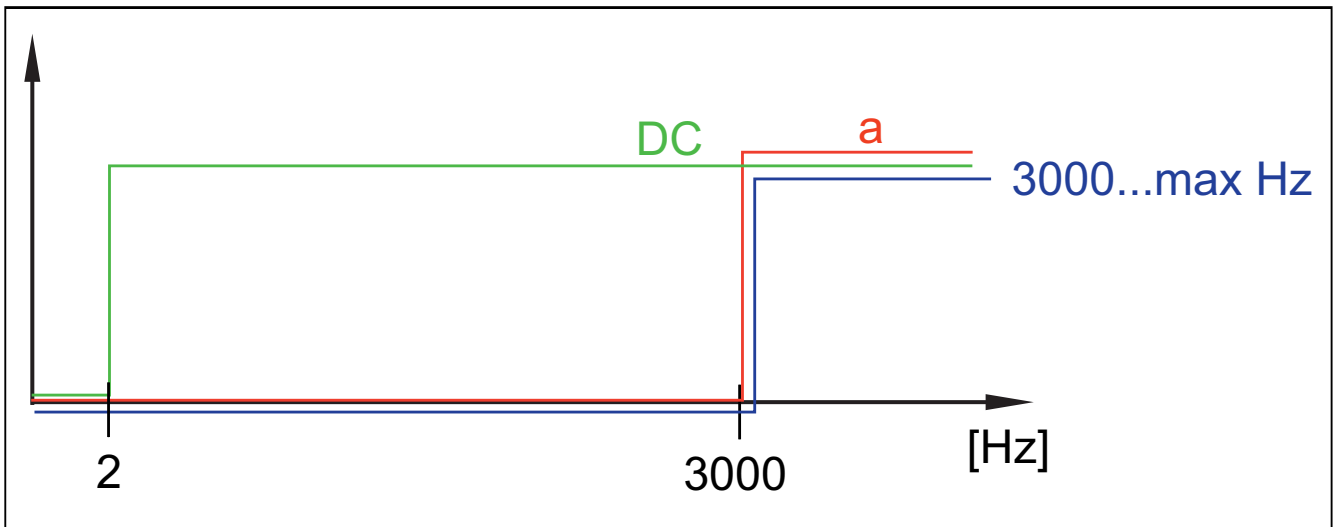

7.3.3 Filter a - evaluation of the signal components > 10 Hz

Settings

DC filter: 10 Hz, high-pass

a filter: bypass

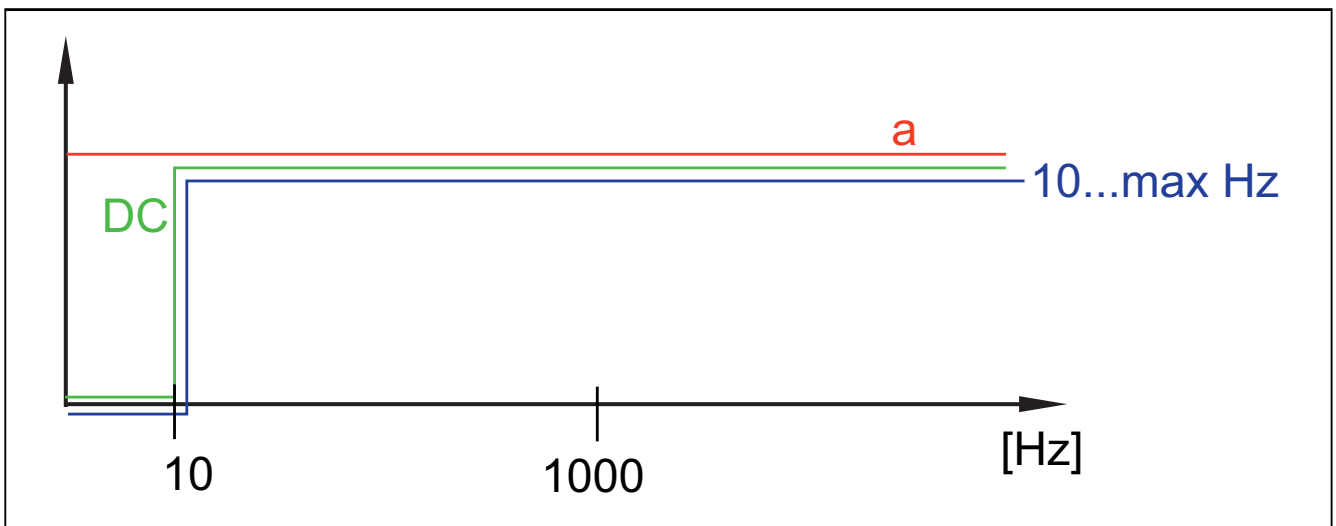

7.3.4 Filter v - evaluation of the signal components between 2...1000 Hz

Settings

DC filter: 2 Hz, high-pass

v filter: 1 kHz, low-pass (fixed)

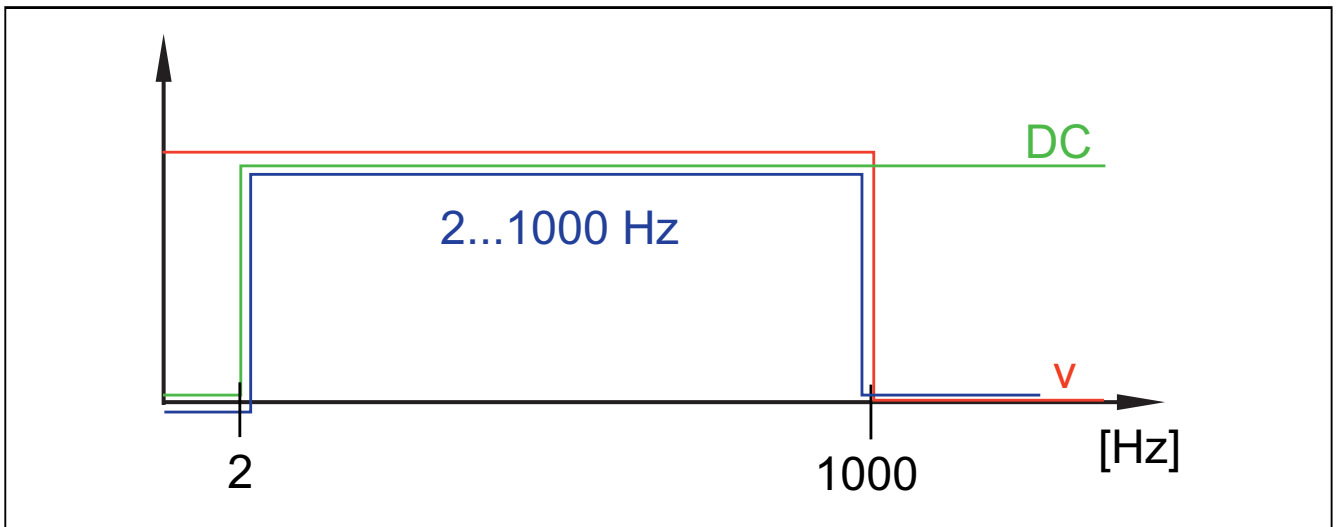

7.3.5 Filter v - evaluation of the signal components between 10...1000 Hz

Settings

DC filter: 10 Hz, high-pass

v filter: 1 kHz, low-pass (fixed)

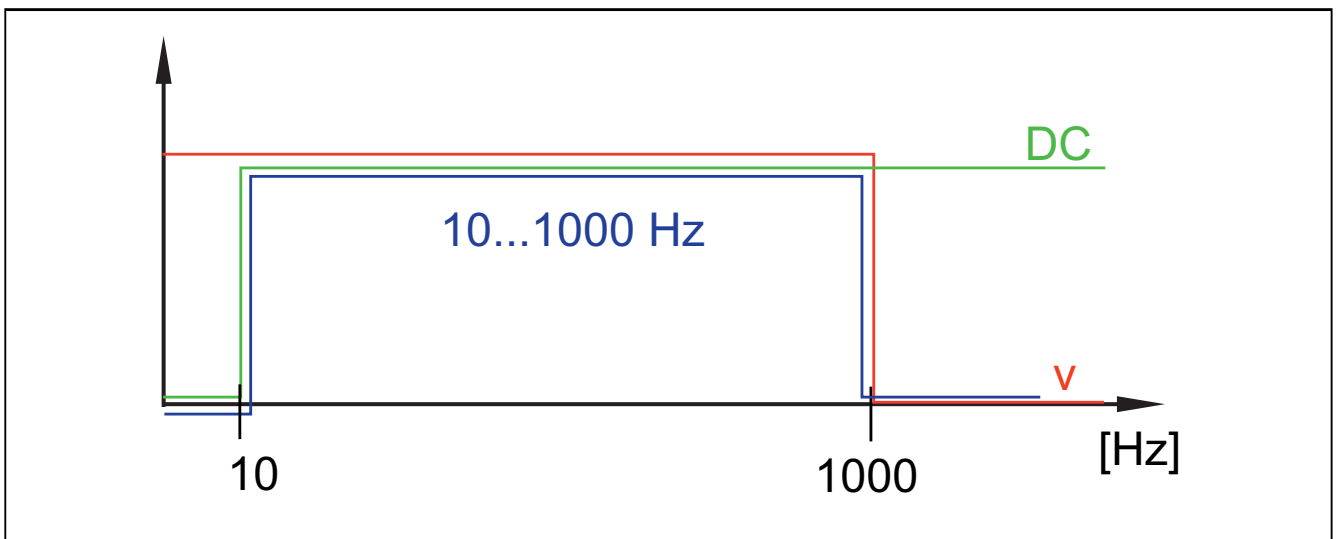

8 Maintenance, repair and disposal

The operation of the unit is maintenance-free. It is not possible to repair the unit. Dispose of the unit in an environmentally friendly way in accordance with the applicable national regulations when it is no longer used.

9 Factory setting

9.1 General configuration

Output configuration	ou1	ou2	P-n
	Hnc	Hnc	PnP
Digital output 1	dS1	dr1	
	0	0	
Digital output 2	dS2	dr2	
	0	0	
Error configuration	FOU1	FOU2	
	OFF	OFF	
Display settings	uni - v-RMS	uni - a-Peak, a-RMS	uni.T
	m/s	m/s ²	°C

9.2 Specific configuration

Output configuration	VVB001	VVB010	VVB011	VVB020	VVB021
SEL1	v-RMS	v-RMS	v-RMS	v-RMS	v-RMS
SEL2	v-RMS	a-RMS	a-RMS	a-RMS	a-RMS
v-RMS [m/s]					
SP1 - v-RMS	0.0045	0.0045	0.0045	0.0028	0.0028
rP1 - v-RMS	0.0043	0.0043	0.0043	0.0026	0.0026
SP2 - v-RMS	0.0071	0.0071	0.0071	0.0045	0.0045
rP2 - v-RMS	0.0069	0.0069	0.0069	0.0043	0.0043
a-Peak [m/s ²]					
SP1 - a-Peak	19.6	19.6	19.6	9.8	9.8
rP1 - a-Peak	17.6	17.6	17.6	7.8	7.8
SP2 - a-Peak	29.4	29.4	29.4	19.6	19.6
rP2 - a-Peak	27.4	27.4	27.4	17.6	17.6
a-RMS [m/s ²]					
SP1 - a-RMS	9.8	3.4	3.4	2.4	2.4
rP1 - a-RMS	7.8	1.4	1.4	0.4	0.4

SP2 - a-RMS	19.6	5.4	5.4	4.4	4.4
rP2 - a-RMS	17.6	3.4	3.4	2.4	2.4
Crest					
SP1 - CREST	5	5	5	5	5
rP1 - CREST	4	4	4	4	4
SP2 - CREST	7	7	7	7	7
rP2 - CREST	6	6	6	6	6
Temperature					
SP1 - TEMP	60	60	60	60	60
rP1 - TEMP	58	58	58	58	58
SP2 - TEMP	80	80	80	80	80
rP2 - TEMP	78	78	78	78	78
Filter DC					
FILT-DC. FCUTOFF	10	10	2	10	2
FILT-DC. Type	High-pass	High-pass	High-pass	High-pass	High-pass
Filter v					
FILT-V. FCUTOFF	1000	1000	1000	1000	1000
FILT-V. Type	Low-pass	Low-pass	Low-pass	Low-pass	Low-pass
Filter a					
FILT-A. FCUTOFF	5000	5000	5000	5000	5000
FILT-A. Type	Bypass	Low-pass	Low-pass	Low-pass	Low-pass