

ifm electronic



Operating instructions  
Electronic pressure sensor

**efectorsoo**

**PY9951**

**PY9964**

**UK**

11450574 / 00 01 / 2015

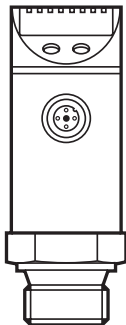

# Contents

1	Preliminary note.....	3
1.1	Symbols used.....	3
2	Safety instructions.....	3
3	Functions and features.....	4
3.1	Applications.....	4
4	Function.....	4
4.1	Output function.....	5
4.1.1	Switching function.....	5
4.1.2	Analogue function.....	6
5	Installation.....	6
6	Electrical connection.....	6
7	Operating and display elements.....	7
8	Menu.....	8
8.1	Explanation of the menu level 1.....	8
8.2	Explanation of the menu level 2.....	9
9	Parameter setting.....	9
9.1	Locking / unlocking.....	10
9.2	Set switching limits.....	10
9.3	Set output functions.....	10
9.4	Extended functions / activate menu level 2.....	11
9.5	Configuration of the display.....	11
9.6	Read min/max values for the system pressure.....	11
9.7	Set delay for the switching outputs.....	11
9.8	Set damping for the switching signal.....	12
10	Operation.....	12
10.1	Read set parameters.....	12
10.2	Faults displayed during operation.....	12

# 1 Preliminary note

## 1.1 Symbols used

- ▶ Instructions
- > Reaction, result
- [...] Designation of keys, buttons or indications
- Cross-reference



Important note

Non-compliance may result in malfunction or interference.



Information

Supplementary note

UK

## 2 Safety instructions

- Please read this document prior to set-up of the unit. Ensure that the product is suitable for your application without any restrictions.
- If the operating instructions or the technical data are not adhered to, personal injury and/or damage to property can occur.
- Improper or non-intended use may lead to malfunctions of the unit or to unwanted effects in your application. That is why installation, electrical connection, set-up, operation and maintenance of the unit must be carried out by qualified personnel authorised by the machine operator.
- In order to guarantee the correct condition of the device for the operating time it is necessary to use the device only for media to which the wetted materials are sufficiently resistant (→ Technical data).



The responsibility whether the measurement device is suitable for the respective application lies with the operator. The manufacturer assumes no liability for consequences of misuse by the operator. Improper installation and use of the devices result in a loss of the warranty claims.

## 3 Functions and features

The unit measures and monitors the system pressure in a plant.

### 3.1 Applications

Type of pressure: relative pressure

Order no.	Measuring range		Permissible Overpressure		Bursting pressure	
	bar	psi	bar	psi	bar	psi
PY9951	0...250	0...3625	100	400	850	12300
PY9964	-1...10 <sup>*)</sup>	-14.5...145	75	1087	150	2175
*) measuring span of the analogue signal for PY9964: 0...10 bar / 0...145 psi.						
$\text{MPa} = (\text{measured value in bar}) \div 10$ $\text{kPa} = (\text{measured value in bar}) \times 100$						



Avoid static and dynamic overpressure exceeding the specified overload pressure by taking appropriate measures.

The indicated bursting pressure must not be exceeded.

Even if the bursting pressure is exceeded only for a short time, the unit may be destroyed. **ATTENTION: Risk of injury!**

Use in gases at pressures > 25 bar only on request.



Pressure Equipment Directive (PED):

The units comply with article 3, section (3) of the Directive 97/23/EC and are designed and manufactured for "non-superheated liquids" of group 2 fluids in accordance with the sound engineering practice.

Restriction for stable gases according to PED (→ 2 Safety instructions).



Further technical data and scale drawing at [www.ifm.com](http://www.ifm.com) → New search  
→ Enter the article number.

## 4 Function

- The unit displays the current system pressure.
- It generates output signals according to the operating mode and the parameter setting.

## 4.1 Output function

<b>OUT1 (pin 4)</b>	• Switching signal for system pressure limit value
<b>OUT2 (pin 2)</b>	2 options: • Analogue signal proportional to pressure 4...20 mA • Analogue signal proportional to pressure 0...10 V

### 4.1.1 Switching function

OUT1 changes its switching state if it is above or below the set switching limits (SP1, rP1). The following switching functions can be selected:

Hysteresis function:

The hysteresis keeps the switching state of the output stable if the system pressure varies about the preset value.

- Hysteresis function / normally open:  $[OU1] = [Hno]$  (→ Fig. 1).
- Hysteresis function / normally closed:  $[OU1] = [Hnc]$  (→ Fig. 1).

First the set point (SP1) is set, then the reset point (rP1).

The hysteresis defined remains even if SP1 is changed again.

Window function:

The window function enables the monitoring of a defined acceptable range.

- Window function / normally open:  $[OU1] = [Fno]$  (→ Fig. 2).
- Window function / normally closed:  $[OU1] = [Fnc]$  (→ Fig. 2).

The width of the window can be set by means of the difference between SP1 and rP1. SP1 = upper value, rP1 = lower value.

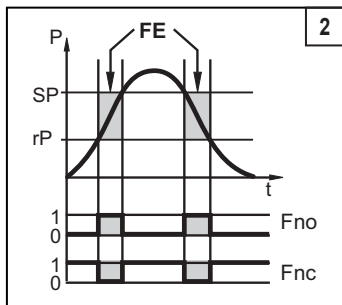
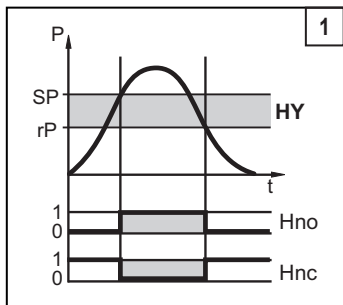

P = system pressure; HY = hysteresis; FE = window

## 4.1.2 Analogue function

OU2 can be configured, it provides an analogue signal proportional to pressure.

- Current output 4...20 mA: [OU2] = [I]
- Voltage output 0...10 V: [OU2] = [U]

## 5 Installation



Before installing and removing the unit: Make sure that no pressure is applied to the system.

- ▶ Insert the unit in a G $\frac{3}{4}$  process connection (see the type label "Port Size").
- ▶ Tighten firmly.

## 6 Electrical connection



The unit must be connected by a qualified electrician.

The national and international regulations for the installation of electrical equipment must be adhered to.

Voltage supply according to SELV, PELV.

- ▶ Disconnect power.
- ▶ Connect the unit as follows:

Core colours			
BK	black		
BN	brown		
BU	blue		
WH	white		
		OUT1: Switching output	
		OUT2: Analogue output	
		Colours to DIN EN 60947-5-2	

## 7 Operating and display elements

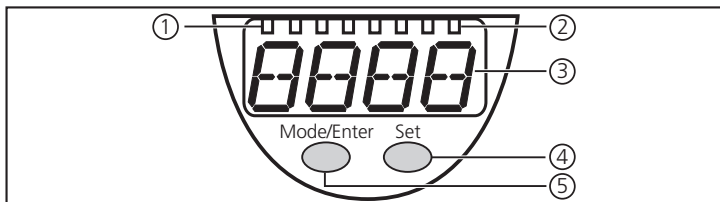

<b>1 indicator LED</b>	
LED 1 ... LED 3	System pressure in the indicated unit of measurement.
<b>2 indicator LEDs</b>	
LED 8	Switching status OUT1 (lights when output 1 is switched).
<b>3: Alphanumeric display, 4 digits</b>	
- Display of the current system pressure. - Indication of the parameters and parameter values.	
<b>4: Mode/Enter button</b>	
- Selection of the parameters and acknowledgement of the parameter values.	
<b>5: Set button</b>	
- Setting value is changed: incrementally by pressing the button once or continuously by keeping the button pressed.	

UK

## 8 Menu

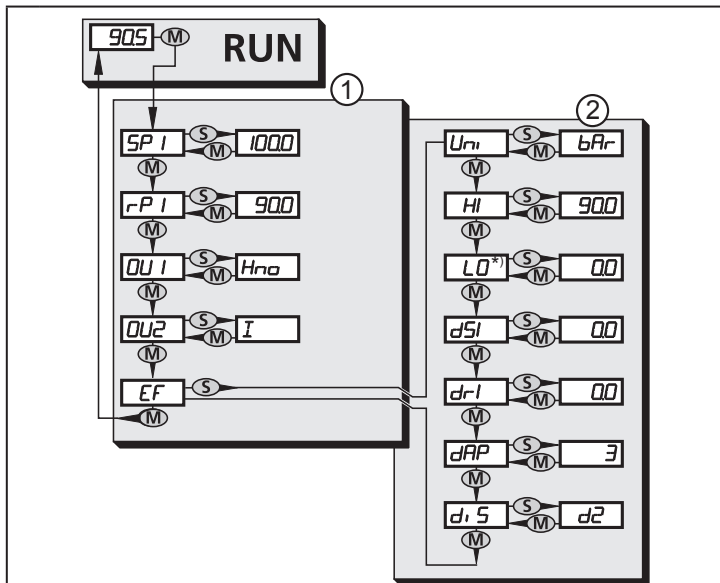

\*) LO display of minimum value memory for system pressure only for PY9964

M Mode/Enter button

S Set button

### 8.1 Explanation of the menu level 1

SP1/rP1	Upper / lower limit value for system pressure at which OUT1 switches.
OU1	Output function for OUT1: <ul style="list-style-type: none"> <li>• Switching signal for the pressure limit values: hysteresis function [H ..] or window function [F ..], either normally open [. no] or normally closed [. nc].</li> </ul>
OU2	Output function for OUT2: <ul style="list-style-type: none"> <li>• Analogue signal for the current system pressure: 4...20 mA [I] or 0...10 V [U]</li> </ul>
EF	Extended functions / opening of menu level 2. If menu level 2 is protected by an access code, "Cod1" flashes in the display. When delivered by ifm electronic: no access restriction





## 8.2 Explanation of the menu level 2

Uni	Standard unit of measurement for system pressure (display): [bar] / [PSI] / [MPA].
HI	Maximum value memory for system pressure.
LO	Minimum value memory for system pressure.
dS1	Switching delay for OUT1.
dr1	Switch-off delay for OUT1.
dAP	Damping of the switching output.
dAA	Damping for analogue output
diS	Update rate and orientation of the display.

UK

## 9 Parameter setting

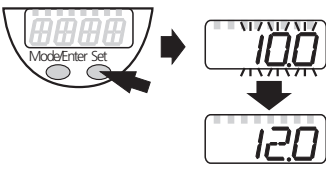
3 steps must be taken for each parameter setting:

<p><b>1 Select parameter</b></p> <ul style="list-style-type: none"> <li>▶ Press [Mode/Enter] until the requested parameter is displayed.</li> </ul>	
<p><b>2 Set parameter value</b></p> <ul style="list-style-type: none"> <li>▶ Press and hold [Set].</li> <li>&gt; Current setting value of the parameter flashes for 5 s.</li> <li>&gt; After 5 s: setting value is changed: incrementally by pressing the button once or continuously by keeping the button pressed.</li> </ul>	
<p>Numerical values are incremented continuously. For reducing the value: let the display move to the maximum setting value. Then the cycle starts again at the minimum setting value.</p>	
<p><b>3 Acknowledge parameter value</b></p> <ul style="list-style-type: none"> <li>▶ Briefly press [Mode/Enter].</li> <li>&gt; The parameter is displayed again. The new setting value is saved.</li> </ul>	

### Set other parameters

- ▶ Start again with step 1 and activate requested parameter.

### Finish parameter setting

- ▶ Press [Mode/Enter] several times until the current measured value is displayed or wait for 15 s.
- > The unit returns to the operating mode.



Select the display unit (Uni) before you define the values for the parameters SP1 und rP1. This avoids rounding errors during internal conversion to other units and enables exact setting of the values. Factory setting : Uni = bAr

## 9.1 Locking / unlocking

The unit can be locked electronically to prevent unintentional settings.

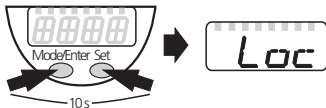
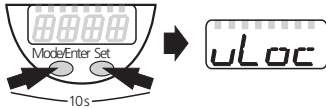
<ul style="list-style-type: none"> <li>▶ Make sure that the unit is in the normal operating mode.</li> <li>▶ Press [Mode/Enter] + [Set].</li> <li>&gt; [Loc] is displayed.</li> </ul>	
<p>During operation: [Loc] is briefly displayed if you try to change parameter values.</p>	
<p>For unlocking:</p> <ul style="list-style-type: none"> <li>▶ Press [Mode/Enter] + [Set].</li> <li>&gt; [uLoc] is displayed.</li> </ul>	

Factory setting: not locked.

### • Timeout:

If no button is pressed for 15 s during parameter setting, the unit returns to the operating mode with unchanged values.

## 9.2 Set switching limits

<ul style="list-style-type: none"> <li>▶ Select [SP1] and set the value at which the output switches.</li> </ul>	<p>SP 1</p>
<ul style="list-style-type: none"> <li>▶ Select [rP1] and set the value at which the output is reset.</li> </ul> <p>rP1 is always lower than SP1. The unit only accepts values which are lower than SP1.</p>	<p>rP 1</p>

## 9.3 Set output functions

<ul style="list-style-type: none"> <li>▶ Select [OU1] and set the switching function:             <ul style="list-style-type: none"> <li>- [Hno] = hysteresis function/NO,</li> <li>- [Hnc] = hysteresis function/NC,</li> <li>- [Fno] = window function/NO,</li> <li>- [Fnc] = window function/NC.</li> </ul> </li> </ul>	<p>OU 1</p>
<ul style="list-style-type: none"> <li>▶ Select [OU2] and set the analogue function:             <ul style="list-style-type: none"> <li>- [I] = current signal 4...20 mA,</li> <li>- [U] = voltage signal 0...10 V.</li> </ul> </li> </ul>	<p>OU2</p>

## 9.4 Extended functions / activate menu level 2

<ul style="list-style-type: none"><li>▶ Select [EF] to open menu level 2</li><li>&gt; Factory setting: No access restriction.</li> <li>&gt; [Cod1] flashes if menu level 2 is protected by an access code.</li><li>▶ Press and hold [Set] until valid code is displayed.</li><li>▶ Press [MODE/ENTER] briefly.</li><li>&gt; Menu level 2 opens.</li></ul>	<b>EF</b>
---	-----------

## 9.5 Configuration of the display

<ul style="list-style-type: none"><li>▶ Select [Uni] and set the unit of measurement:<ul style="list-style-type: none"><li>- [bar]</li><li>- [PSI]</li><li>- [MPa]</li></ul></li></ul>	<b>Uni</b>
<ul style="list-style-type: none"><li>▶ Select [diS] and set the update rate and orientation of the display:<ul style="list-style-type: none"><li>- [d1]: update of the measured values every 50 ms.</li><li>- [d2]: update of the measured values every 200 ms.</li><li>- [d3]: update of the measured values every 600 ms.</li><li>- [rd1], [rd2], [rd3]: display as for d1, d2, d3; rotated by 180°.</li><li>- [OFF] = The measured value display is deactivated in the Run mode. Touching one of the buttons indicates the current measured value for 15 s. Pressing the [Mode/Enter] button again activates the display mode. The LEDs remain active even if the display is deactivated.</li></ul></li></ul>	<b>d, S</b>

## 9.6 Read min/max values for the system pressure

<ul style="list-style-type: none"><li>▶ Select [HI] or [LO] and briefly press [Set]. [HI] = maximum value, [LO] = minimum value. Delete memory:<ul style="list-style-type: none"><li>▶ Select [HI] or [LO].</li><li>▶ Press and hold [Set] until [----] is displayed.</li><li>▶ Briefly press [Mode/Enter].</li></ul></li></ul>	<b>HI</b> <b>LO</b>
---	------------------------

## 9.7 Set delay for the switching outputs

<p>[dS1] = switch-on delay for OUT1. [dr1] = switc-off delay for OUT1 / OUT2.</p> <ul style="list-style-type: none"><li>▶ Select [dS1] or [dr1] and set the value between 0.2 and 50 s in steps of 0.2 s (at 0.0 the time delay is not active).</li></ul>	<b>dS 1</b> <b>dr 1</b>
---	----------------------------

## 9.8 Set damping for the switching signal

▶ Select [dAP] ▶ Set one of the following values; they define the switching frequency (f) of the output:										
dAP	3	6	10	17	30	60	125	250	500	
f (Hz)	170	80	50	30	16	8	4	2	1	
dAP value = response time between pressure change and change of the switching status in milliseconds (ms).										

## 10 Operation

After power on, the unit is in the Run mode (= normal operating mode). It carries out its measurement and evaluation functions and provides output signals according to the set parameters.

### 10.1 Read set parameters

- ▶ Press [Mode/Enter] until the requested parameter is displayed.
- ▶ Briefly press [Set].
- > The unit displays the corresponding parameter value for approx. 15 s. After about 15 s it again displays the parameter, then it returns to the Run mode.

### 10.2 Faults displayed during operation

Display	Type of fault	Corrective measures
none	Supply voltage too low.	▶ Check / correct the supply voltage.
SC1 flashes	Excessive current at switching output OUT1 *).	▶ Check switching output OUT1 for short-circuit or excessive current; remove the fault.
OL	Process value too high. (measuring range exceeded)	▶ Check / reduce system pressure / select unit with corresponding measuring range.
UL	Process value too low (value below measuring range).	▶ Check / increase system pressure / select unit with corresponding measuring range.
*) The output remains deactivated as long as the excessive current / short circuit continues. These messages are displayed even if the display is switched off.		

More information at [www.ifm.com](http://www.ifm.com)

