

Info card

Full-metal inductive sensors with IO-Link



i This info card serves as a supplement to the main position sensors catalogue and to the individual data sheets. For further information and contact addresses please visit our website at www.ifm.com.

Intended use

While in use the products are exposed to influences which may have an effect on function, life, quality and reliability of the product.

It is the customer's responsibility to ensure that the products are suitable for the intended application. This applies in particular to applications in hazardous areas and with adverse environmental influence such as pressure, chemicals, temperature fluctuations, moisture and radiation as well as mechanical stress, especially if the products are not installed properly.

Using the products in applications where the safety of people depends on the function of the product is not permitted. Non-compliance may result in death or serious injuries.

Operating principle of an inductive proximity switch with IO-Link

Coil and capacitor form an LC resonant circuit, also called basic sensor.

If a target penetrates the sensor field, eddy currents are generated in the target, taking away energy from the sensor. The circuit ensures that even when a target is in contact with the sensor a process value is provided depending on the distance.

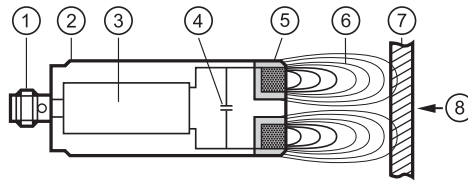

- ① Connection
- ② Housing
- ③ Downstream electronics
- ④ Capacitor
- ⑤ Coil
- ⑥ Alternating electromagnetic field = active zone
- ⑦ Target = electrically conductive material
- ⑧ Ideal direction of movement of the target

Glossary of important terms

Active zone	Area above the sensing face in which the sensor reacts to the approach of the target.
Number of switching operations	0...2000000 -> starts again at 0 when the maximum value has been reached.
Output function	Normally open: Object within the active zone > output supplied with current. Normally closed: Object within the active zone > output not supplied with current. Parameterisable: Choice between normally closed or normally open. Positive switching: Positive output signal (to L-). Negative switching: Negative output signal (to L+).
Switch-off delay	Can be set in steps of 100 ms.
Rated insulation voltage	DC units with protection class III: 60 V DC
Rated short-circuit current	For short-circuit-proof units: 100 A
Rated impulse withstand voltage	DC units with protection class III: 0.8 kV (Δ overvoltage category II)
Power-on delay time	The time the sensor needs to be ready for operation after application of the operating voltage (in the millisecond range).

Operating voltage	Voltage range in which the sensor operates reliably. A stabilised and smoothed direct voltage should be used. Take into account the residual ripple.
Operating hours	0...2000000 -> remains on the maximum value when it has been reached.
Damping	Smoothing the output signal (PDV) with fluctuating distance value; can be set in steps of 10 ms.
Start-up delay	Can be set in steps of 100 ms.
Setting range	Range in which a switch point can be set.
Utilisation category	DC units: DC-13 (control of solenoids)
Hysteresis	Difference between the switch-on and the switch-off point.
Short-circuit protection	If ifm sensors are protected against overload by means of a pulsed short-circuit protection, the inrush current of incandescent lamps, electronic relays or low resistance loads may cause this protection to cut in and turn the sensor off.
Linearity error	Deviation of the output characteristics from the preset value characteristics.
Measuring range	Range in which the process value changes.
Final value of the measuring range	Maximum value which the process value can reach within the measuring range.
Standard target	Square-shaped steel plate (e.g. S235JR) of a thickness of 1 mm with a side length equal to the diameter of the sensing face or 3 x final value of the measuring range (S_n), depending on which value is the highest.
Product standard	IEC 60947-5-2
Switch point drift	The shifting of the switch point if the ambient temperature changes.
Switching frequency	Damping with standard target at half the final value of the measuring range (S_n). The ratio damped to undamped (tooth to gap) = 1 : 2.

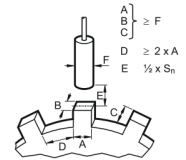

i Observe the cycle time of IO-Link.

Protection	IPxy According to IEC 60529 IP68 Test condition: 1 m water depth for 7 days IP69k To ISO 20653 (replacement for DIN 40050-9)
Current consumption	Current for the internal supply of 3-wire DC units.
Temperature drift	See switch point drift.
Transport and storage conditions	Unless otherwise indicated in the data sheet, the following applies: Transport and storage temperature: Min. = - 40 °C. Max. = max. ambient temperature according to the data sheet. The relative air humidity (RH) must not exceed 50 % at +70 °C. At lower temperatures, a higher air humidity is permissible. Shelf life: 5 years. Transport and storage height: no restrictions.
Degree of soiling	Inductive proximity sensors are designed for degree of soiling 3.
Maintenance, repair and disposal	If used correctly, no maintenance and repair measures are necessary. Only the manufacturer is allowed to repair the unit. After use dispose of the unit in an environmentally friendly way in accordance with the applicable national regulations.
Repeatability	Difference between any two measurements within the measuring range.

Info card

Full-metal inductive sensors with IO-Link



Correction factors

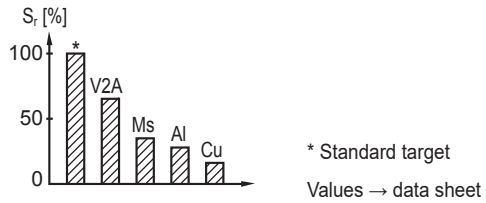

i With materials and sizes deviating from the standard target the short range signal via IO-Link cannot be guaranteed.

Representation of the process value with measuring range and setting range with front damping

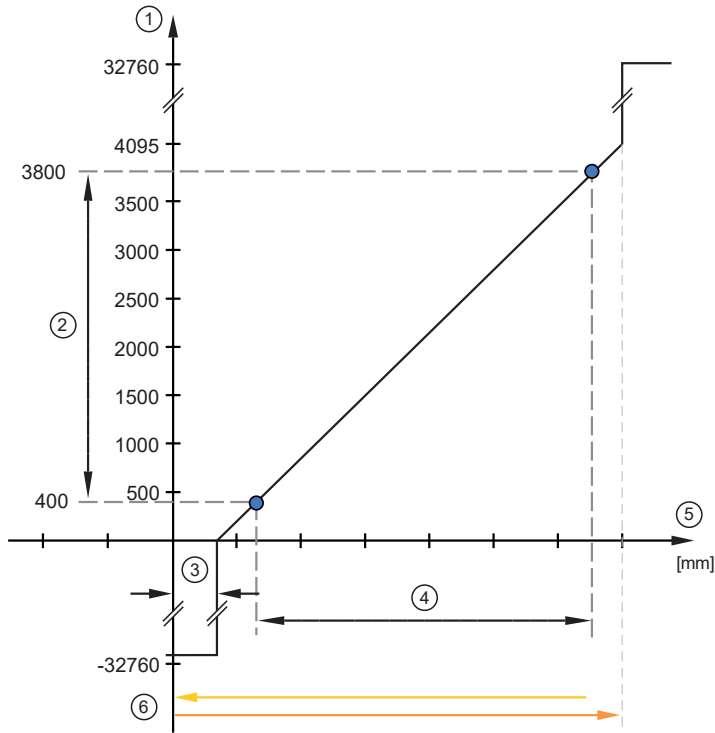

- ① Process data value
- ② PDV setting range (process data variable)
- ③ Short range
- ④ Setting range
- ⑤ Distance to the sensing face
- ⑥ SIO LED (factory setting)

Hysteresis in % referred to the process value

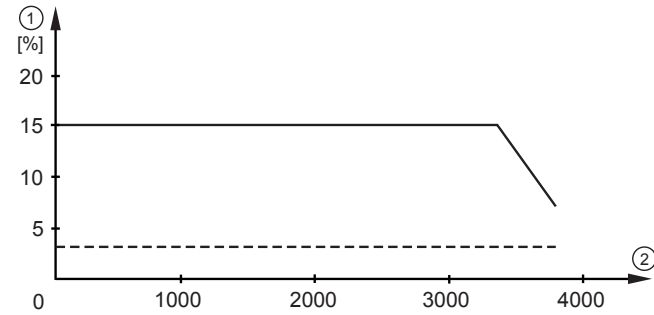

- ① Hysteresis
- ② Process value

Approach and ranges (valid for structural steel, e.g. S235JR)

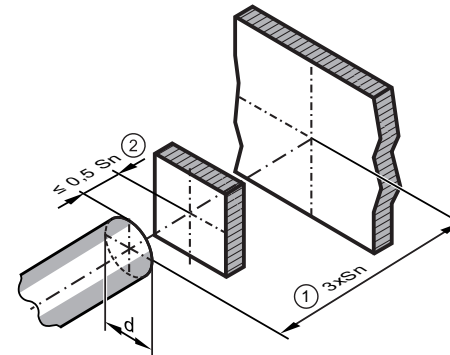

- ① Distance to the background
- ② Recommended target distance in SIO mode

UK

Info card

Full-metal inductive sensors with IO-Link



Switch point definition IO-Link

Single point mode (presence detection) to smart sensor profile 2

Normally open: (switch point logic = 0)

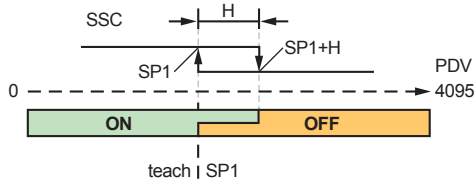

Normally closed: (switch point logic = 1)

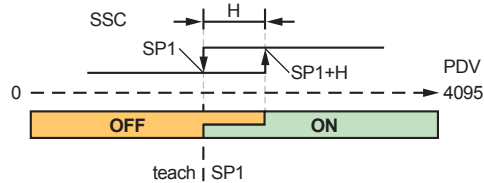

SP1 switch-on point
SP1 + H switch-off point

SP1 switch-off point
SP1 + H switch-on point

Window mode (presence detection) to smart sensor profile 2

Normally open: (switch point logic = 0)

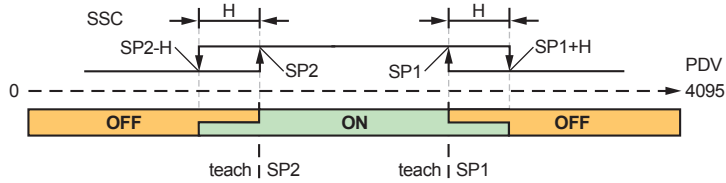

SP1 switch-on point
SP1 + H switch-off point

SP2 switch-on point
SP2 - H switch-off point

Normally closed: (switch point logic = 1)

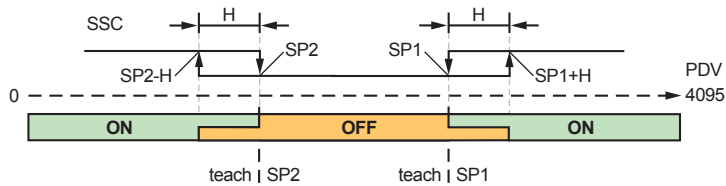

SP1 switch-off point
SP1 + H switch-on point

SP2 switch-off point
SP2 - H switch-on point

Two point mode (presence detection) to smart sensor profile 2

Normally open: (switch point logic = 0)

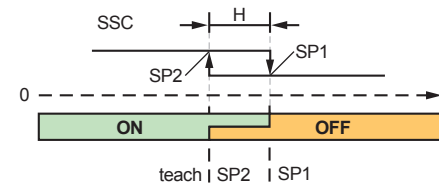

SP1 switch-off point
SP2 switch-on point

Normally closed: (switch point logic = 1)

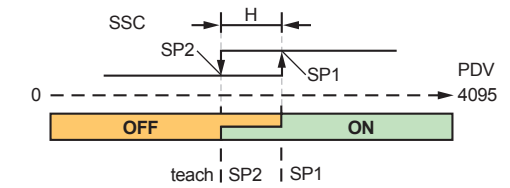

SP1 switch-on point
SP2 switch-off point



Condition:
SP1 > SP2 + 3% and SP1 between 400 and 3800 and SP2 between 388 and 3686

SP switch point
H hysteresis
SSC switching signal channel
PDV process data variable

UK

Info card

Full-metal inductive sensors with IO-Link



Tips on flush and non-flush mounting in metal

Installation instructions cylindrical designs

Flush:

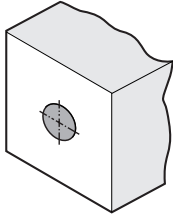

Non-flush:

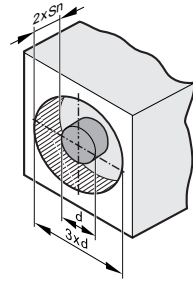

Installation instructions rectangular designs

Flush:

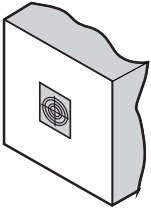

Non-flush:

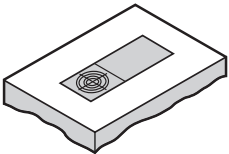
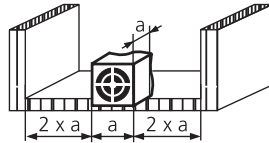

Minimum clearance for installing units of the same type (side-by-side installation)

Applies to cylindrical and rectangular sensors.

Flush:

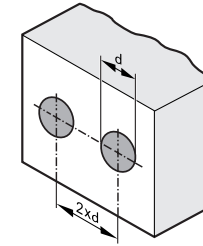

Non-flush:

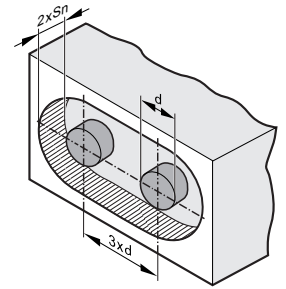

i The minimum distance between units may only be disregarded for units with different oscillator frequencies or different sensing principles.

Connection systems

! The unit must be connected by a qualified electrician.

3-wire technology (negative or positive switching)

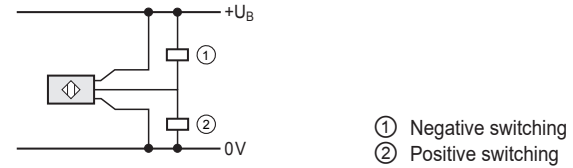

- ① Negative switching
- ② Positive switching

Pin configuration of the US-100 connectors (view onto the plug at the unit)

- Pin 1: BN
- Pin 3: BU
- Pin 4: BK



- Colours:
 BK: black
 BN: brown
 BU: blue

IO-Link diagnostic data

- Process value above the valid range Warning
- Process value below the valid range Warning
- Hardware failure in the device (e.g. sensor head damaged) Error message

UK