



Operating instructions
RF-identification system

GB

ANT434
ANT435

Read/write head



Contents

1	Preliminary note	3
1.1	Symbols used	3
1.2	Warnings used	3
1.3	Legal and copyright information	3
2	Safety instructions	4
3	Intended use	5
4	Items supplied	6
5	Function	7
5.1	ID tags	7
5.2	Device overview	7
6	Installation	8
6.1	Notes on the unit installation	8
6.2	Avoiding interference	8
6.3	Mechanical design	8
6.4	Install device	9
6.5	Mounting distances	9
6.6	Positioning of the ID tags	10
7	Electrical connection	12
7.1	Wiring	12
8	Operating and display elements	13
9	Operation	14
10	Maintenance, repair and disposal	15
11	Approvals/standards	16
	Glossary	17

1 Preliminary note

You will find instructions, technical data, approvals and further information using the QR code on the unit / packaging or at www.ifm.com.

1.1 Symbols used

- ✓ Requirement
- ▶ Instructions
- ▷ Reaction, result
- [...] Designation of keys, buttons or indications
- Cross-reference
-  Important note
Non-compliance may result in malfunction or interference.
-  Information
Supplementary note

1.2 Warnings used

ATTENTION

Warning of damage to property

1.3 Legal and copyright information

© All rights reserved by ifm electronic gmbh. No part of these instructions may be reproduced and used without the consent of ifm electronic gmbh.

All product names, pictures, companies or other brands used on our pages are the property of the respective rights owners.

2 Safety instructions

General

- The unit described is a subcomponent for integration into a system.
 - The system architect is responsible for the safety of the system.
 - The system architect undertakes to perform a risk assessment and to create documentation in accordance with legal and normative requirements to be provided to the operator and user of the system. This documentation must contain all necessary information and safety instructions for the operator, the user and, if applicable, for any service personnel authorised by the architect of the system.
- Read this document before setting up the product and keep it during the entire service life.
- The product must be suitable for the corresponding applications and environmental conditions without any restrictions.
- Only use the product for its intended purpose (→ → Intended use).
- If the operating instructions or the technical data are not adhered to, personal injury and/or damage to property may occur.
- The manufacturer assumes no liability or warranty for any consequences caused by tampering with the product or incorrect use by the operator.
- Installation, electrical connection, set-up, operation and maintenance of the product must be carried out by qualified personnel authorised by the machine operator.
- Protect units and cables against damage.

Radio equipment

In general, radio equipment must not be used in the vicinity of petrol stations, fuel depots, chemical plants or blasting operations.

- ▶ Do not transport and store any flammable gases, liquids or explosive substances near the unit.

Interference of electronic and medical devices

Operation can affect the function of electronic devices that are not correctly shielded.

- ▶ Disconnect the device in the vicinity of medical equipment.
- ▶ Contact the manufacturer of the corresponding device in case of any interference.

3 Intended use

The read/write head reads and writes ID tags without contact. For use, the read/write head must be connected to the DTE10x evaluation unit.

The data is converted into digitally coded values and provided to the evaluation unit.

4 Items supplied

- Read/write head
- 2x hexagonal nut



The device is supplied without installation and connection accessories.

Available accessories: www.ifm.com.

The optimum function is not ensured when using components from other manufacturers.

5 Function

5.1 ID tags

The **ID tags** are passively operated without a battery. The energy required for operation is provided by the read/write head.

The energy is provided via an inductive coupling. The integrated antenna coil in the read/write head generates a magnetic field which partly penetrates the antenna coil of the ID tag. A voltage is generated by induction that supplies the data carrier with energy.

The device supports ID tags according to ISO 15693.

5.2 Device overview

ANT434

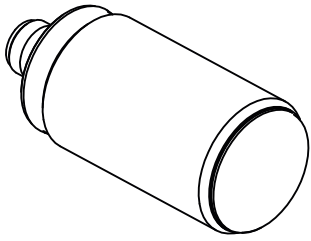

	Article number:	ANT434
	Function:	Read/write head
	Type designation:	DTRHF IBRWIDUS03
	Type:	M30, flush mountable

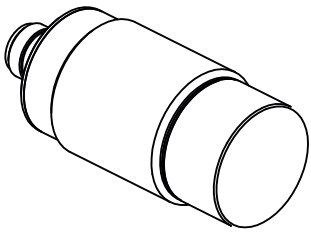
ANT435

	Article number:	ANT435
	Function:	Read/write head
	Type designation:	DTRHF INRWIDUS03
	Type:	M30, non flush mountable

6 Installation

6.1 Notes on the unit installation

-  When mounting several RFID units adhere to the minimum distances between the systems.
-  Flush mounting of a read/write head in metal reduces the read/write distance.
-  Device performance can be affected if positioned in the immediate vicinity of powerful HF emission sources such as welding transformers or converters.

6.2 Avoiding interference

The device generates a modulated electrical field with a frequency of 13.56 MHz.

Avoid interference with data communication:

- ▶ Do not operate any devices in the vicinity that use the same frequency band.
- ▷ Such devices are for example frequency converters and switched-mode power supplies.

If there are other devices in the same frequency band in the vicinity:

- ▶ The mounting distances between the devices should be as large as possible.
- ▶ Use the devices in alternating operation.
- ▶ Switch the HF field of the device on/off.

6.3 Mechanical design

ANT434

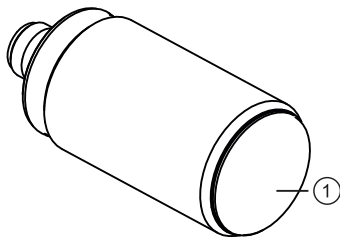

Fig. 1: ANT434

1 Sensing face

ANT435

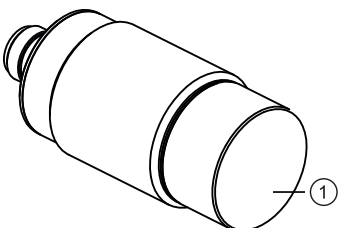

Fig. 2: ANT435

1 Sensing face

6.4 Install device

► Fix the device using the supplied nuts (M30).

ANT434

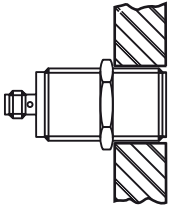

Fig. 3: Flush mounting

ANT435

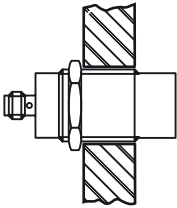
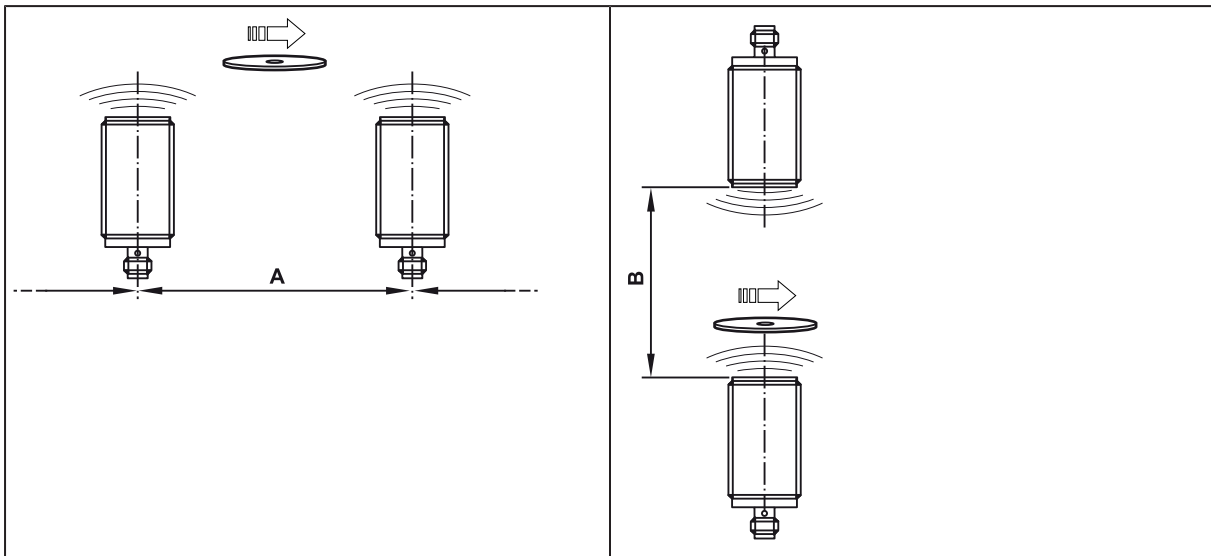

Fig. 4: Non flush mounting

6.5 Mounting distances

ANT434



Operating mode	Distance side (A)	Distance front (B)
For reading and writing	≥ 50 mm	≥ 100 mm

ANT435

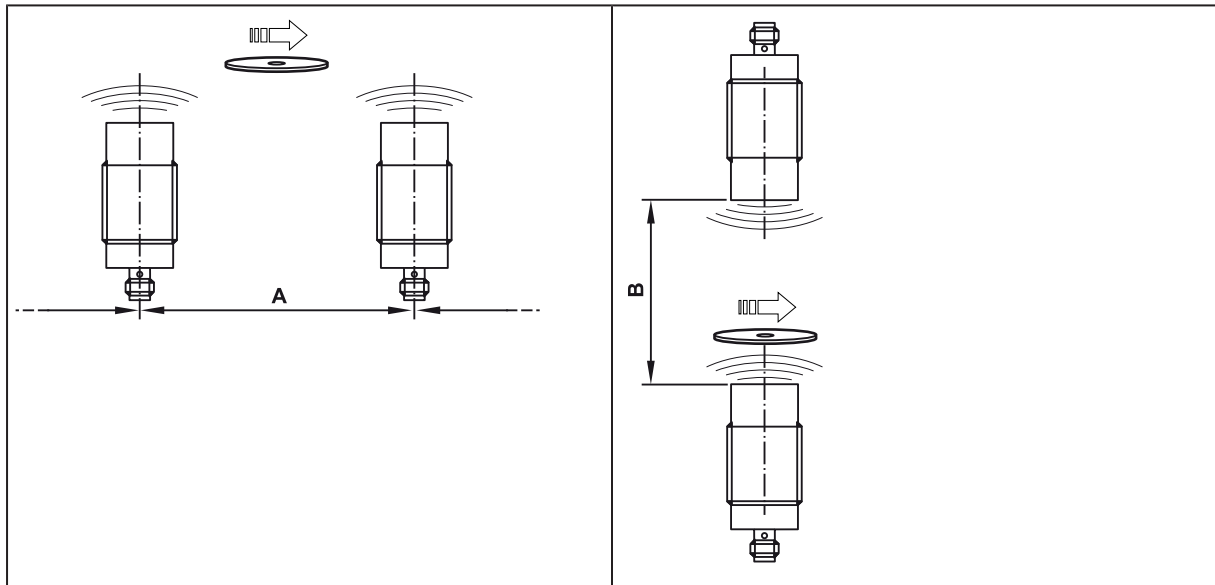

Operating mode	Distance side (A)	Distance front (B)
For reading and writing	≥ 120 mm	≥ 160 mm

6.6 Positioning of the ID tags

- !** The read/write heads are marked with an antenna symbol on the sensing face. It designates the middle of the integrated antenna coil and has to correspond with the middle of the ID tag.
 - ▶ Align the axes of the RFID device and the ID tag in the same way.
- !** For installation in or on metal use the ID tags provided for this purpose.
- !** Position the ID tag in the area of the sensing face. When doing so, the angle of aperture and the operating distance must be adhered to (→ Data sheet of the device).

ANT434

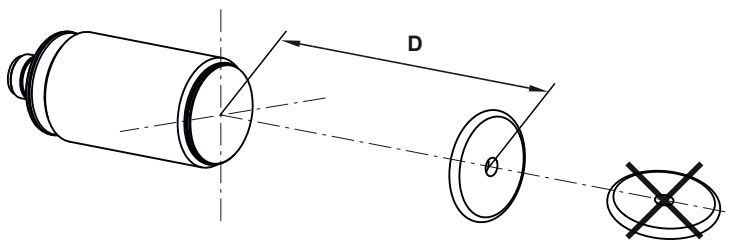



Fig. 5: Position the ID tag

- ▶ Align the ID tag on the central axis of the antenna of the unit.

ID tag	Type	Distance read/write head (D) in metal	Distance read/write head (D) in plastic
E80370		20 mm	20 mm
E80371		25 mm	30 mm

 The indications in the table apply to static read/write operations.

ANT435

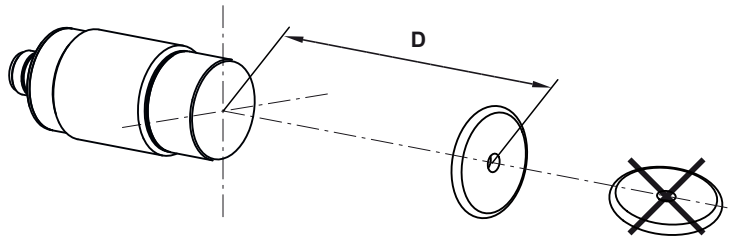
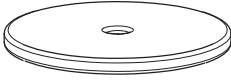
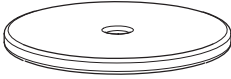



Fig. 6: Position the ID tag

► Align the ID tag on the central axis of the antenna of the unit.

ID tag	Type	Distance read/write head (D) in metal	Distance read/write head (D) in plastic
E80370		35 mm	35 mm
E80371		45 mm	45 mm

 The indications in the table apply to static read/write operations.

7 Electrical connection



The device must be connected by a qualified electrician.

Device of protection class III (PC III).

The electrical supply must only be made via PELV/SELV circuits.

- ▶ Disconnect power before connecting the device.

7.1 Wiring

- ▶ Connect the unit to a DTE10x evaluation unit via the M12 connector.

- ▷ Voltage is supplied via the evaluation unit.

Pin assignment	Wiring



Information on available sockets see: www.ifm.com.

Cables with the following characteristics are suitable for the connection:

Length	Ohmic resistance (feed + return line)	Effective cable capacity
< 20 m	max. 3 Ω	max. 3 nF

8 Operating and display elements

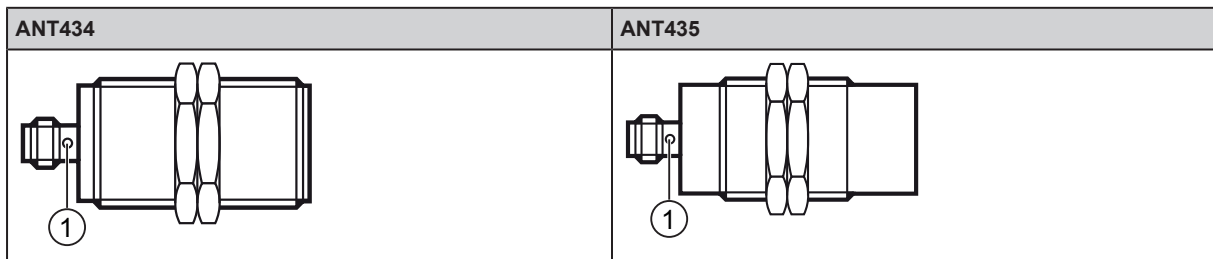

1 LED green: Operating voltage
LED yellow: ID tag

LED	State	Description
green	on	operating voltage OK
	off	operating voltage missing
	flashing slowly	deactivated
yellow	on (permanently)	ID tag detected
	on (pulse)	ID tag read/written successfully
	flashing quickly	error when reading/writing on ID tag
	off	<ul style="list-style-type: none"> • no ID tag in the field • faulty ID tag in the field • invalid ID tag in the field
green and yellow	flashing alternately	error in communication or device fault

9 Operation

The read/write head is configured via the connected evaluation unit DTE10x.

Further information on operation can be found in the operating instructions of the evaluation unit:
www.ifm.com

10 Maintenance, repair and disposal

The unit is maintenance-free.

- ▶ Contact ifm in case of malfunction.
- ▶ Do not open the housing as the unit does not contain any components which can be maintained by the user. The unit must only be repaired by the manufacturer.
- ▶ Clean the device using a dry cloth.
- ▶ Dispose of the unit in accordance with the national environmental regulations.

11 Approvals/standards

For approvals and standards, the following information is available:

- Test standards and regulations: documentation.ifm.com
- EU declaration of conformity and approvals: documentation.ifm.com
- Notes relevant for approval: package inserts of the device

Glossary

ID tag

An ID tag is used to identify objects. A read/write device is used to read the ID tag via a high-frequency radio signal. An ID tag consists of an antenna, an analogue circuit for receiving and transmitting (transceiver), a digital circuit and a non-volatile memory.