

ifm electronic



Operating instructions  
Pressure sensor

**efectorsoo**

**PY9961**

**UK**

11450575 / 00 05 / 2010

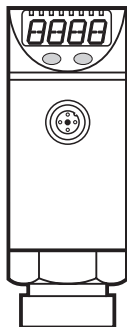

# Contents

1 Preliminary note.....	3
1.1 Symbols used.....	3
2 Safety instructions .....	3
3 Functions and features .....	4
4 Function.....	4
4.1 Processing of the measured signals.....	4
4.2 Switching function.....	4
4.3 Diagnostic function .....	5
5 Installation.....	5
6 Electrical connection.....	6
7 Operating and display elements .....	7
8 Menu.....	8
8.1 Menu structure.....	8
8.2 Explanation of the menu.....	9
9 Parameter setting .....	10
9.1 General parameter setting.....	10
9.2 Configuring the display (optional).....	12
9.3 Setting the output signals .....	12
9.3.1 Setting of the output function.....	12
9.3.2 Setting of the switching limits .....	12
9.4 User settings (optional) .....	13
9.4.1 Setting of a time delay for the switching signals.....	13
9.4.2 Setting of the damping for the switching outputs.....	13
9.5 Service functions .....	13
9.5.1 Reading the min./max. values for the system pressure.....	13
9.5.2 Reset all parameters to the factory setting.....	13
10 Operation.....	14
10.1 Reading of the set parameters .....	14
10.2 Fault indication .....	14
11 Scale drawing .....	15
12 Technical data.....	16

12.1 Setting ranges .....	17
13 Factory setting .....	17

## 1 Preliminary note

### 1.1 Symbols used

- ▶ Instruction
- > Reaction, result
- [...] Designation of pushbuttons, buttons or indications
- Cross-reference

 Important note:  
Non-compliance can result in malfunctions or interference.

## 2 Safety instructions

- Please read this document prior to set-up of the unit. Ensure that the product is suitable for your application without any restrictions.
- If the operating instructions or the technical data are not adhered to, personal injury and/or damage to property can occur.
- Check the compatibility of the product materials (→ chapter 12 Technical data) with the media to be measured in all applications.
- For gaseous media the application is limited to max. 25 bar.

### 3 Functions and features

The unit monitors the system pressure of machines and plants.

#### Applications

Type of pressure: relative pressure

Order no.	Measuring range		Permissible overpressure		Bursting pressure	
	bar	PSI	bar	PSI	bar	PSI
PY9961	0...250	0...3 620	400	5 800	850	12 300

$$\text{MPa} = \text{bar} \div 10 / \text{kPa} = \text{bar} \times 100$$



Avoid static and dynamic overpressure exceeding the given overload pressure by taking appropriate measures.

The indicated bursting pressure must not be exceeded.

Even if the bursting pressure is exceeded only for a short time, the unit may be destroyed. NOTE: Risk of injury!

For gaseous media the application is limited to max. 25 bar.

## 4 Function

### 4.1 Processing of the measured signals

- The unit displays the current system pressure.
- It generates 2 output signals according to the parameter setting.

<b>OUT1</b>	• Switching signal for system pressure limit value.
<b>OUT2</b>	2 options • Switching signal for system pressure limit value. • Diagnostic signal (output 2 is inactive in case of a fault).

### 4.2 Switching function

OUTx changes its switching state if it is above or below the set switching limits (SPx, rPx). The following switching functions can be selected:

- Hysteresis function / normally open: [OUx] = [Hno] (→ fig. 1).
- Hysteresis function / normally closed: [OUx] = [Hnc] (→ fig. 1).

First the set point (SPx) is set, then the reset point (rPx) with the requested difference.

- Window function / normally open: [OUx] = [Fno] (→ fig. 2).
- Window function / normally closed: [OUx] = [Fnc] (→ fig. 2).

The width of the window can be set by means of the difference between SPx and rPx. SPx = upper value, rPx = lower value.

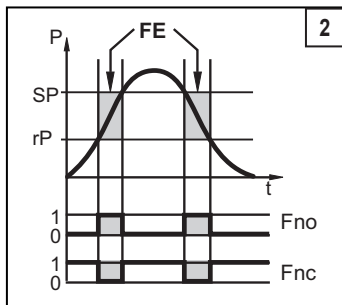
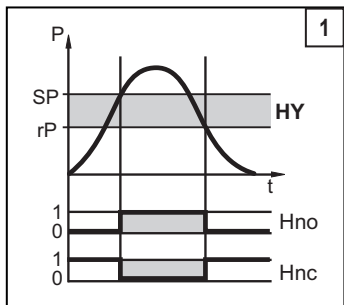

P = system pressure; HY = hysteresis; FE = window

### 4.3 Diagnostic function

Output 2 is used as diagnostic output based on the DESINA specification if [OU2] = [dESI].

- If there is no fault, the output is switched and carries UB+.
- In case of malfunctions in the following areas, the output is inactive:
  - short circuit in output 1,
  - EEPROM fault,
  - RAM fault,
  - processor fault.

## 5 Installation



Before mounting and removing the sensor, make sure that no pressure is applied to the system.

- ▶ Insert the unit in a G $\frac{1}{4}$  process connection.
- ▶ Tighten firmly.

## 6 Electrical connection



The unit must be connected by a qualified electrician.

The national and international regulations for the installation of electrical equipment must be adhered to.

Voltage supply to SELV, PELV.

- ▶ Disconnect power.
- ▶ Connect the unit as follows:

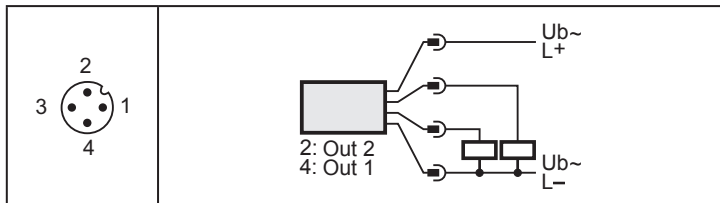

<b>Pin 1</b>	Ub+ / Ub~
<b>Pin 3</b>	Ub- / Ub~
<b>Pin 4 (OUT1)</b>	• binary switching output pressure monitoring
<b>Pin 2 (OUT2)</b>	• binary switching output if [OU2] = [Hno], [Hnc], [Fno] or [Fnc] • diagnostic output if [OU2] = [dESI]

Core colours of ifm sockets:

1 = BN (brown), 2 = WH (white), 3 = BU (blue), 4 = BK (black)

## 7 Operating and display elements

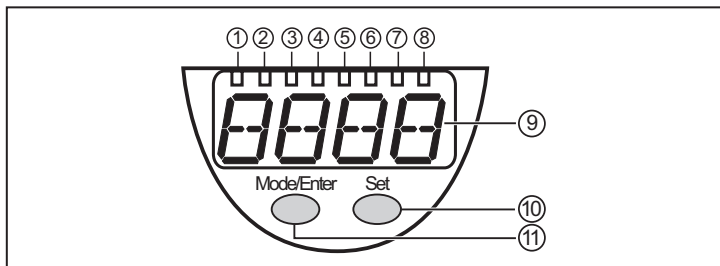

### 1 to 8: Indicator LEDs

- LED 1 to LED 3 = system pressure in unit of measurement as indicated on the label.
- LEDs 4, 5 and 6 not used.
- LED 7, LED 8 = switching state of the corresponding output.

### 9: Alphanumeric display, 4 digits

- Indication of the current system pressure.
- Indication of the parameters and parameter values.

### 10: Set pushbutton

- Setting of the parameter values (scrolling by holding pressed, incremental by pressing briefly).

### 11: Mode/Enter pushbutton

- Selection of the parameters and acknowledgement of the parameter values.

## 8 Menu

### 8.1 Menu structure

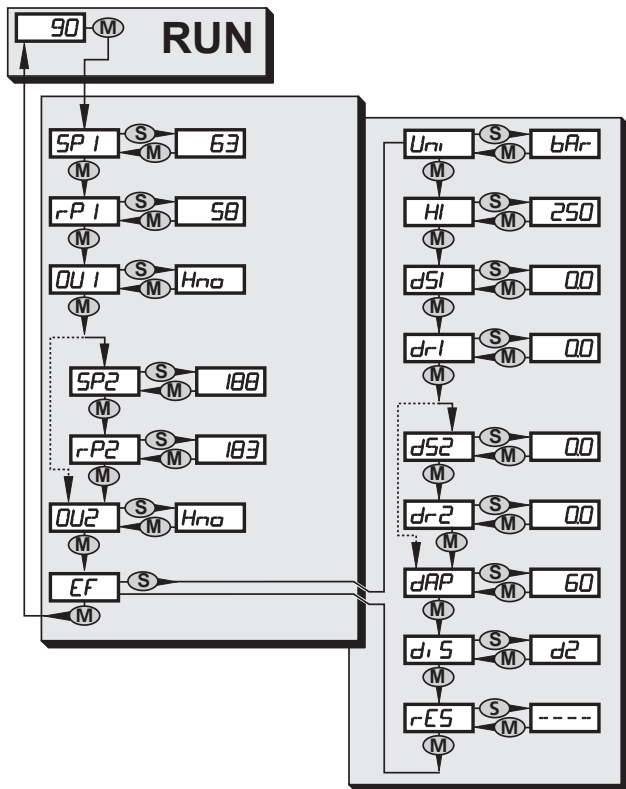



## 8.2 Explanation of the menu

SP1/rP1	Upper / lower limit value for system pressure at which OUT1 switches.
SP2/rP2	Upper / lower limit value for system pressure at which OUT2 switches.
OU1	Output function for OUT1: <ul style="list-style-type: none"><li>• Switching signal for the pressure limit values: hysteresis function [H ..] or window function [F ..], either normally open [. no] or normally closed [. nc].</li></ul>
OU2	Output function for OUT2: <ul style="list-style-type: none"><li>• Switching signal for the pressure limit values: hysteresis function [H ..] or window function [F ..], either normally open [. no] or normally closed [. nc].</li><li>• Diagnostic signal [OU2] = dESI.</li></ul>
EF	Extended functions / opening of menu level 2.
Uni	Standard unit of measurement for system pressure.
HI	Maximum value memory for system pressure.
dS1/dS2	Switch-on delay for OUT1 / OUT2.
dr1/dr2	Switch-off delay for OUT1 / OUT2.
dAP	Damping for the switching outputs.
diS	Update rate and orientation of the display.
rES	Restore factory setting.



UK

## 9 Parameter setting

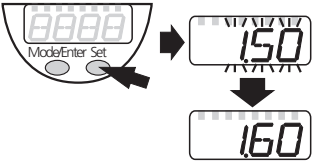

During parameter setting the unit remains in the operating mode. It continues its monitoring function with the existing parameters until the parameter setting has been completed.

### 9.1 General parameter setting

3 steps must be taken for each parameter setting:

<b>1</b>	<b>Parameter selection</b> ▶ Press [Mode/Enter] until the requested parameter is displayed.	
<b>2</b>	<b>Setting of the parameter value</b> ▶ Press [Set] and keep it pressed. > Current setting value of the parameter flashes for 5 s. > After 5 s: setting value is changed: incrementally by pressing the button once or continuously by keeping the button pressed.	
Numerical values are incremented continuously. To reduce the value: let the display move to the maximum setting value. Then the cycle starts again at the minimum setting value.		
<b>3</b>	<b>Acknowledgement of the parameter value</b> ▶ Press [Mode/Enter] briefly. > The parameter is displayed again. The new setting value is stored.	
<b>Setting of other parameters:</b> ▶ Start again with step 1.		
<b>Finishing the parameter setting:</b> ▶ Press [Mode/Enter] several times until the current measured value is displayed or wait for 15 s. > The unit returns to the operating mode.		

- Change from menu level 1 to menu level 2:

<p>▶ Press [Mode/Enter] until [EF] is displayed.</p> <p>If the submenu is protected with an access code, "Cod1" flashes in the display.</p> <p>▶ Press [Set] and keep it pressed until the valid code no. is displayed.</p> <p>▶ Press [Mode/Enter] briefly.</p> <p>On delivery by ifm electronic: no access restriction.</p>	
<p>▶ Press [Set] briefly.</p> <p>&gt; The first parameter of the sub-menu is displayed (here: [Un]).</p>	

UK

- Locking / unlocking

The unit can be locked electronically to prevent unintentional settings.

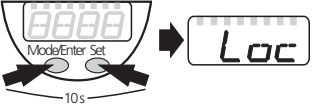
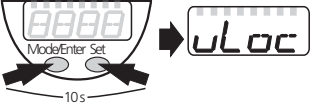
<p>▶ Make sure that the unit is in the normal operating mode.</p> <p>▶ Press [Mode/Enter] + [Set] for 10 s.</p> <p>&gt; [Loc] is displayed.</p>	
<p>During operation: [Loc] is briefly displayed if you try to change parameter values.</p>	
<p>For unlocking:</p> <p>▶ Press [Mode/Enter] + [Set] for 10 s.</p> <p>&gt; [uLoc] is displayed.</p>	

On delivery: unlocked.

- Timeout:

If no button is pressed for 15 s during parameter setting, the unit returns to the operating mode with unchanged values.

## 9.2 Configuring the display (optional)

<p>▶ Select [Uni] and set the unit of of measurement: [bar], [MPa], [PSI].</p>	<i>Uni</i>
<p>▶ Select [diS] and set update rate and orientation of the display:</p> <ul style="list-style-type: none"><li>- [d1]: Update of the measured value every 50 ms.</li><li>- [d2]: Update of the measured value every 200 ms.</li><li>- [d3]: Update of the measured value every 600 ms.</li><li>- [rd1], [rd2], [rd3]: Display like d1, d2, d3; rotated by 180°.</li><li>- [OFF]: The display is deactivated in the operating mode.</li></ul>	<i>d1 S</i>

## 9.3 Setting the output signals

### 9.3.1 Setting of the output function

<p>▶ Select [OU1] and set the function:</p> <ul style="list-style-type: none"><li>- [Hno] = hysteresis function / normally open</li><li>- [Hnc] = hysteresis function / normally closed,</li><li>- [Fno] = window function / normally open,</li><li>- [Fnc] = window function / normally closed</li></ul>	<i>OU 1</i>
<p>▶ Select [OU2] and set the function:</p> <ul style="list-style-type: none"><li>- [Hno] = hysteresis function / normally open,</li><li>- [Hnc] = hysteresis function / normally closed,</li><li>- [Fno] = window function / normally open,</li><li>- [Fnc] = window function / normally closed,</li><li>- [dES1] = output 2 is used as a diagnostic output.</li></ul>	<i>OU2</i>

### 9.3.2 Setting of the switching limits

<p>▶ Select [SP1] / [SP2] and set the value at which the output switches.</p>	<i>SP 1</i> <i>SP2</i>
<p>▶ Select [rP1] / [rP2] and set the value at which the output switches off. rPx is always smaller than SPx. The unit only accepts values which are lower than the value for SPx.</p>	<i>rP 1</i> <i>rP2</i>

## 9.4 User settings (optional)

### 9.4.1 Setting of a time delay for the switching signals

[dS1] / [dS2] = switch-on delay for OUT1 / OUT2.

[dr1] / [dr2] = switch-off delay for OUT1 / OUT2.

- ▶ Select [dS1], [dS2], [dr1] or [dr2] and set a value between 0.2 and 50 s (at 0.0 the delay time is not active).

dS1  
dS2  
dr1  
dr2

### 9.4.2 Setting of the damping for the switching outputs

- ▶ Select [dAP] and set a value.

dAP value = response time between pressure change and change of the switching status in milliseconds.

The following fix values can be set; they define the switching frequency (f) of the output:

dAP	3	6	10	17	30	60	125	250	500
f [Hz]	170	80	50	30	16	8	4	2	1

dAP

UK

## 9.5 Service functions

### 9.5.1 Reading the min./max. values for the system pressure

- ▶ Select [HI], press [Set] briefly.  
Delete memory:
  - ▶ Select [HI].
  - ▶ Press [Set] until [----] is displayed.
  - ▶ Press [Mode/Enter] briefly.

HI

### 9.5.2 Reset all parameters to the factory setting

- ▶ Select [rES].
  - ▶ Press [Set] until [----] is displayed.
  - ▶ Press [Mode/Enter] briefly.

rES

## 10 Operation

After power on, the unit is in the Run mode (= normal operating mode). It carries out its measurement and evaluation functions and provides output signals according to the set parameters.

Operating indications → chapter 7 Operating and display elements.

### 10.1 Reading of the set parameters

- ▶ Press [Mode/Enter] until the requested parameter is displayed.
- ▶ Press [Set] briefly.
- > The unit displays the corresponding parameter value for about 15 s. After another 15 s the unit returns to the Run mode.

### 10.2 Fault indication

[OL]	Overload pressure (measuring range exceeded)
[UL]	Underload pressure (below measuring range)
[SC1]	Short circuit in OUT1*
[SC2]	Short circuit in OUT2*
[SC]	Short circuit in both outputs*
[Loc]	Setting pushbuttons locked, parameter change rejected.
[Err]	Flashing: internal fault

\*The output concerned is switched off as long as the short circuit exists.

The messages SC1, SC2, SC, and Err are shown even if the display is switched off.

## 11 Scale drawing

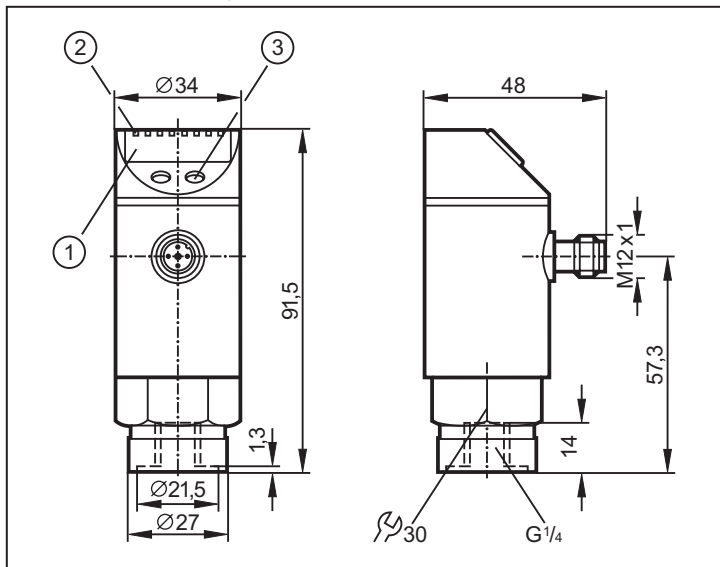

Dimensions are in millimeters

1: display

2: LED's

3: programming button

## 12 Technical data

Operating voltage [V].....	18...55 DC / 24 AC $\pm$ 20 % <sup>1)</sup>
Current consumption [mA].....	< 50
Current rating per switching output [mA] .....	100
Reverse polarity protection, overload protection .....	up to 60 V DC / 40 V A
Short-circuit protection; Integrated watchdog	
Voltage drop [V] .....	< 3
Power-on delay time [s] .....	0.5
Switching frequency [Hz] .....	max.170
Accuracy / deviations (in % of the span)	
- Set point accuracy .....	< $\pm$ 0.5
- Deviation of the characteristics .....	< $\pm$ 0.25 (BFSL) / < $\pm$ 0.5 (LS)
- Hysteresis.....	< 0.25
- Repeatability (in case of temperature fluctuations < 10 K).....	< $\pm$ 0.1
- Long-term stability (in % of the span per 6 months) .....	< $\pm$ 0.05
- Temperature coefficients (TEMPCO) in the compensated temperature range 0 ... 80 °C (in % of the span per 10 K)	
- Greatest TEMPCO of the zero point / of the span .....	< $\pm$ 0.2 / < $\pm$ 0.2
Materials (wetted parts) .....	stainless steel (303S22); ceramics; FPM (Viton)
Housing material .....	stainless steel (304S15); stainless steel (316S12); PBTP (Pocan); PEI; FPM (Viton); EPDM/X (Santoprene)
Protection .....	IP 67 III
Insulation resistance [M $\Omega$ ] .....	> 100 (500 V DC)
Shock resistance [g] .....	50 (DIN / IEC 68-2-27, 11ms)
Vibration resistance [g] .....	20 (DIN / IEC 68-2-6, 10 - 2000 Hz)
Switching cycles min. ....	100 million
Operating temperature [°C] .....	-20...80
Medium temperature [°C] .....	-25 ... +80
Storage temperature[°C].....	-40 ... +100
EMC EN 61000-4-2 ESD: .....	4 / 8 KV
EN 61000-4-3 HF radiated: .....	10 V/m
EN 61000-4-4 Burst: .....	2 KV
EN 61000-4-5 Surge: .....	0.5 / 1 KV
EN 61000-4-6 HF conducted: .....	10 V

<sup>1)</sup> to EN50178, SELV, PELV

BFSL = Best Fit Straight Line / LS = Limit Value Setting



## 12.1 Setting ranges

		SP1 / SP2		rP1 / rP2		$\Delta P$
		min	max	min	max	
<b>PY9961</b>	bar	2	250	1	249	1
	PSI	40	3620	20	3600	20
	MPa	0.2	25.0	0.1	24.9	0.1

$\Delta P$  = increments

## 13 Factory setting

UK

	Factory setting	User setting
SP1	63 bar	
rP1	58 bar	
OU1	Hno	
OU2	Hno	
SP2	188 bar	
rP2	183 bar	
dS1	0.0	
dr1	0.0	
dS2	0.0	
dr2	0.0	
dAP	60	
diS	d2	
Uni	bAr	

More information at [www.ifm.com](http://www.ifm.com)