

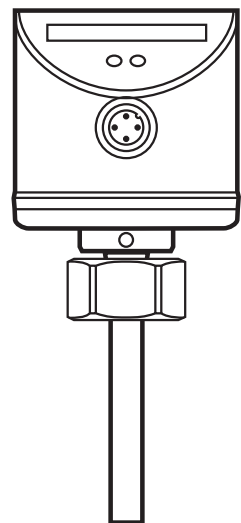

Operating instructions  
Flow monitor  
**SI5007**

**UK**

11458779 / 00 09 / 2018



# Contents

1	Preliminary note.....	3
1.1	Explanation of symbols.....	3
2	Safety instructions .....	4
3	Functions and features .....	4
3.1	Applications .....	4
3.2	Operating principle flow monitoring .....	4
3.3	Operating principle temperature monitoring .....	5
4	Installation.....	6
4.1	Installation location .....	6
4.2	Interference in the pipe system .....	7
4.3	Installation procedure .....	7
5	Electrical connection.....	8
6	Operating and display elements .....	9
7	Parameter setting .....	9
7.1	IO-Link .....	9
7.1.1	General information .....	9
7.1.2	Device-specific information.....	10
7.1.3	Parameter setting tools.....	10
7.1.4	Adjustable parameters .....	10
7.2	Set-up and settings for water.....	10
7.3	Change switch point SP1 for flow (optional).....	11
7.4	High-flow adjustment (optional) .....	11
7.5	Set switch point SP2 for temperature .....	12
7.6	Low-flow adjustment (optional).....	13
7.7	Configuration of the switching outputs (optional).....	13
7.8	Restore the factory setting (reset) .....	14
7.9	Lock / unlock the unit.....	14
7.10	Switch-on / switch-off delay .....	14
8	Operation .....	15
8.1	Display current temperature and switch point SP2.....	15
8.2	Operating indicators .....	15
8.3	Interference indicators .....	16

9 Troubleshooting .....	16
10 Maintenance .....	17
11 Technical data .....	17

# 1 Preliminary note

## 1.1 Explanation of symbols

- ▶ Instructions
- > Reaction, result
- Cross-reference



Important note

Non-compliance can result in malfunction or interference.



Information

Supplementary note.



LED lights green



LED lights orange



LED lights red



LED flashes

## 2 Safety instructions

- Please read this document prior to set-up of the unit. Ensure that the product is suitable for your application without any restrictions.
- If the operating instructions or the technical data are not adhered to, personal injury and/or damage to property can occur.
- Improper or non-intended use may lead to malfunctions of the unit or to unwanted effects in your application. That is why installation, electrical connection, set-up, operation and maintenance of the unit must only be carried out by qualified personnel authorised by the machine operator.
- In order to guarantee the correct condition of the device for the operating time the device must only be used in media to which the wetted parts are sufficiently resistant (→ Technical data).
- The responsibility whether the measurement devices are suitable for the respective application lies with the operator. The manufacturer assumes no liability for consequences of misuse by the operator. Improper installation and use of the devices result in a loss of the warranty claims.

## 3 Functions and features

### 3.1 Applications

The unit monitors the flow and the temperature of liquid and gaseous media.

### 3.2 Operating principle flow monitoring

- The unit detects the flow speed to the calorimetric measuring principle and switches output OUT1:
    - output OUT1 closed if medium is flowing / output open if no medium is flowing.
- This applies to the unit on delivery: output = normally open. If necessary you can change the outputs to normally closed function (→ 7.7). It then applies: output OUT1 open if medium is flowing.
- If the flow speed increases, the switching status changes when the switch point is reached.
  - If the flow speed falls again, the switching status changes when the value "SP minus hysteresis" is reached.

The hysteresis changes with the flow speed and it is essentially influenced by the set monitoring range.

It is 2...5 cm/s for the setting 5...100 cm/s (= factory setting), it increases with higher flow speeds.

- The typical response time of the unit is 1...10 s. It can be influenced by the switch point:
  - Low switch point = quick reaction with rising flow.
  - High switch point = quick reaction with falling flow.

### 3.3 Operating principle temperature monitoring

UK

The unit detects the current medium temperature and switches output OUT2:

- output OUT2 closed if medium temperature  $\geq$  switch point SP2 / output open if medium temperature  $<$  SP2.

This applies to the unit on delivery: output = normally open. If necessary you can change the outputs to normally closed function ( $\rightarrow$  7.7). It then applies: output OUT2 open if medium temperature  $\geq$  SP2.

## 4 Installation

Using process adapters the unit can be adapted to different process connections.

- Adapters have to be ordered separately as accessories.  
A correct fit of the unit and ingress resistance of the connection are only ensured using ifm adapters.
- For small flow rates ifm adapter blocks are available.

### 4.1 Installation location

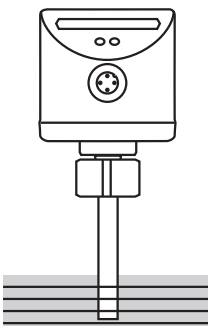
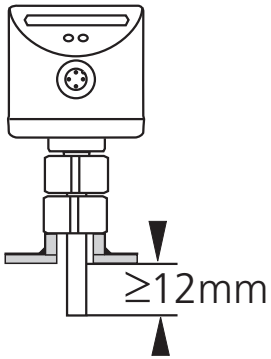
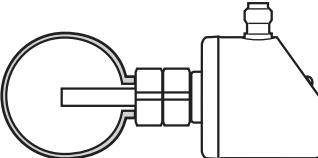
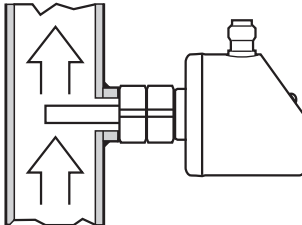
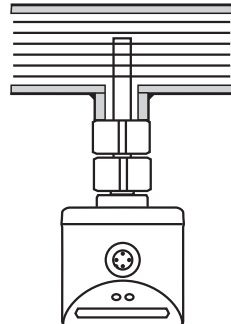
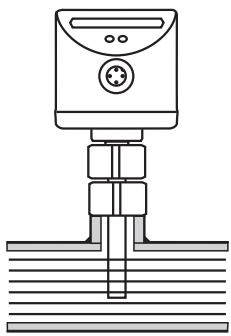
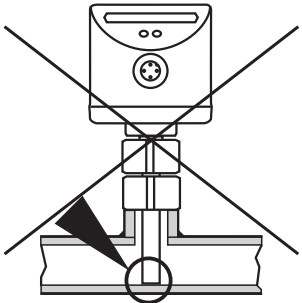
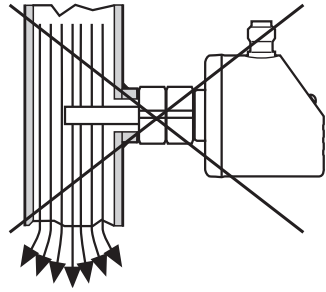
<p><b>General</b></p> <ul style="list-style-type: none"> <li>• The sensor tip is to be completely surrounded by the medium.</li> <li>• Immersion depth of the sensor: minimum 12 mm.</li> </ul>		
<p><b>Recommended</b></p> <ul style="list-style-type: none"> <li>• For horizontal pipes: mounting from the side.</li> <li>• For vertical pipes: mounting in the rising pipe.</li> </ul>		
<p><b>Conditional</b></p> <ul style="list-style-type: none"> <li>• Horizontal pipe / mounting from the bottom: if the pipe is free from build-up.</li> <li>• Horizontal pipe / mounting from the top: if the pipe is completely filled with medium.</li> </ul>		
<p><b>To be avoided</b></p> <ul style="list-style-type: none"> <li>• The sensor tip must not be in contact with the pipe wall.</li> <li>• Do not mount in downpipes that are open at the bottom!</li> </ul>		

## 4.2 Interference in the pipe system

Components integrated in the pipes, bends, valves, reductions, etc. lead to turbulence of the medium. This affects the function of the unit.

Recommendation: Adhere to the distances between sensor and sources of interference:

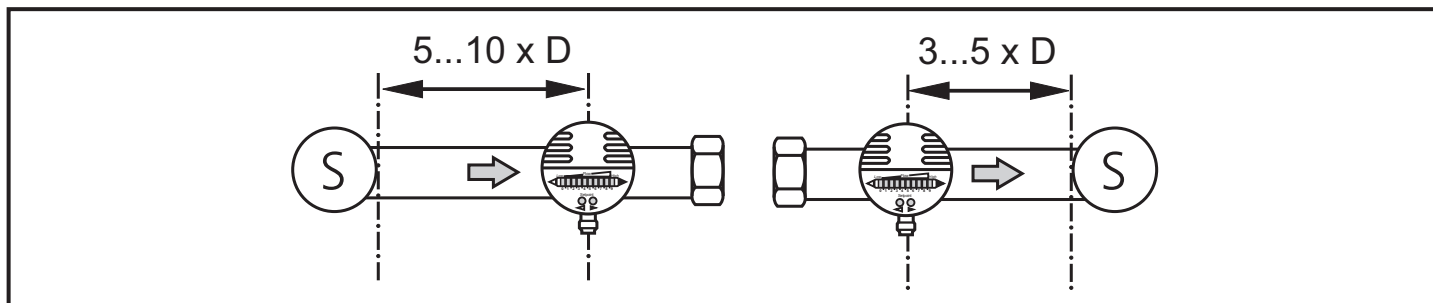

$D$  = pipe diameter;  $S$  = sources of interference

## 4.3 Installation procedure



- ▶ Ensure that the system is free of pressure during installation.
- ▶ Ensure that no media can leak at the mounting location during installation.

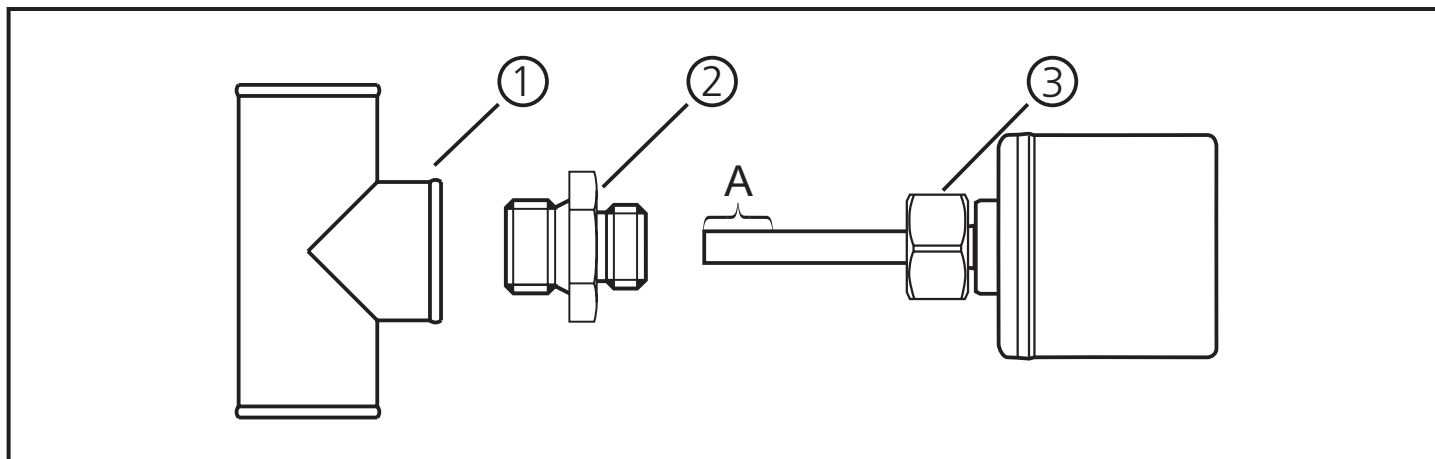

- ▶ Grease the threads of the process connection (1), adapter (2) and nut (3).  
Note: No grease must be applied to the sensor tip (A).
- ▶ Screw suitable adapter into the process connection.
- ▶ Place the flow monitor onto the adapter and tighten the nut. Tightening torque 25 Nm. Ensure that the unit is correctly oriented.

## 5 Electrical connection



The unit must be connected by a qualified electrician.

The national and international regulations for the installation of electrical equipment must be adhered to.

Voltage supply according to EN 50178, SELV, PELV.

- ▶ Disconnect power.
- ▶ Connect the unit as follows:

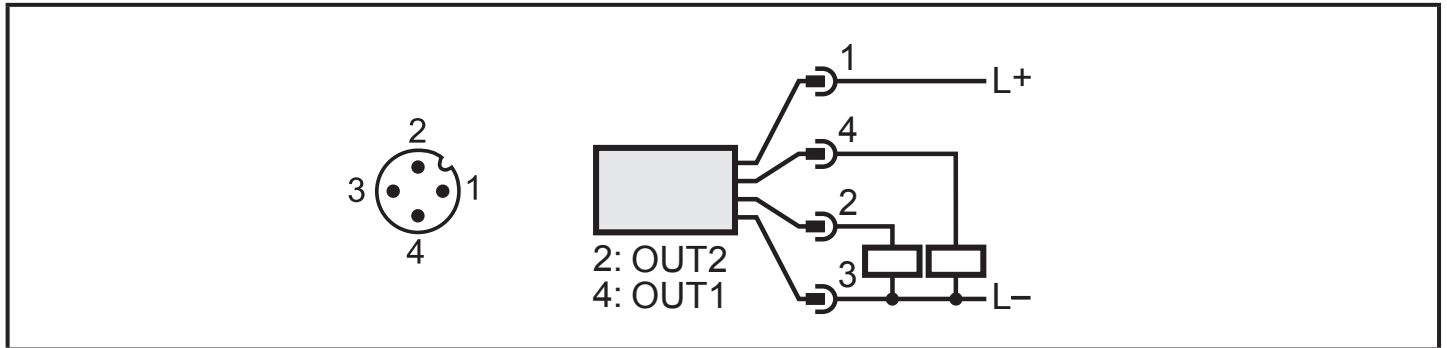

<b>Pin 1</b>	Ub+
<b>Pin 2</b>	<ul style="list-style-type: none"> <li>• OUT2 (PNP): switching signal for temperature monitoring</li> <li>• Programming wire for remote setting</li> </ul>
<b>Pin 3</b>	Ub-
<b>Pin 4</b>	<ul style="list-style-type: none"> <li>• OUT1 (PNP): switching signal for flow monitoring</li> <li>• IO-Link</li> </ul>



# 6 Operating and display elements

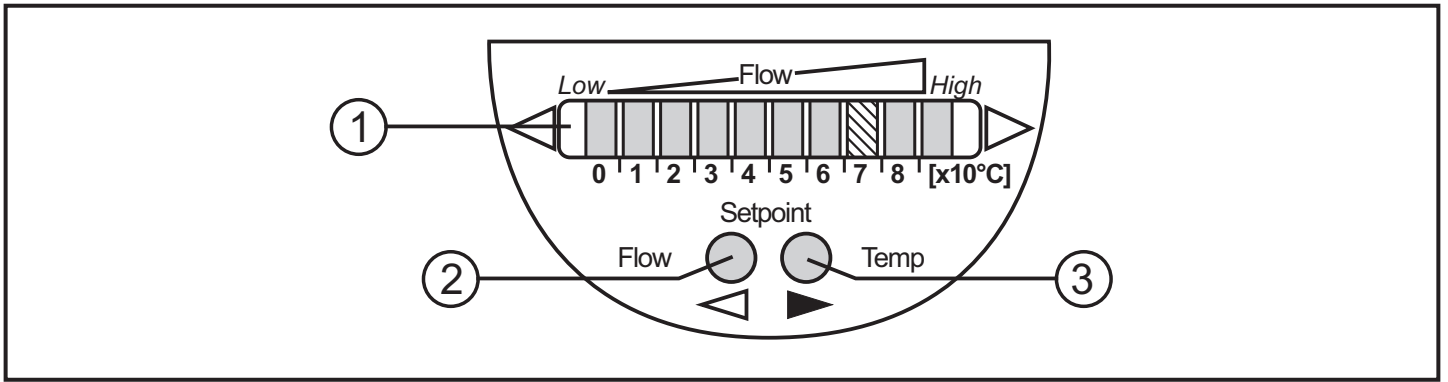

## 1: Operation indication

- The green LEDs indicate the current flow (LEDs 0 to 9 represent the range between flow standstill and maximum flow).
- A lit LED indicates the position of the switch point flow (SP1) (orange = output closed, red = output open).

## 2, 3: Setting buttons for adjustment and configuration

# 7 Parameter setting

Parameters can be set before installation and set-up of the unit or during operation.



- ! If you change parameters during operation, this will influence the function.
  - ▶ Ensure that there will be no malfunctions in your plant.

## 7.1 IO-Link

### 7.1.1 General information

This unit has an IO-Link communication interface which requires an IO-Link-capable module (IO-Link master) for operation.

The IO-Link interface enables direct access to the process and diagnostic data and provides the possibility to set the parameters of the unit during operation.

In addition communication is possible via a point-to-point connection with a USB adapter cable.

You will find more detailed information about IO-Link at [www.ifm.com/gb/io-link](http://www.ifm.com/gb/io-link).

UK

## 7.1.2 Device-specific information

You will find the IODDs necessary for the configuration of the IO-Link unit and detailed information about process data structure, diagnostic information and parameter addresses at [www.ifm.com/gb/io-link](http://www.ifm.com/gb/io-link).

## 7.1.3 Parameter setting tools

You will find all necessary information about the required IO-Link hardware and software at [www.ifm.com/gb/io-link](http://www.ifm.com/gb/io-link).

## 7.1.4 Adjustable parameters

SP1 / rP1	Upper / lower limit value for flow at which OUT1 switches
SP2 / rP2	Upper / lower limit value for temperature at which OUT2 switches
OU1	Output configuration OUT1 (flow)
OU2	Output configuration OUT2 (temperature)
Set_High	Reading of the maximum flow (100 %)
Set_Low	Reading of the minimum flow (0 %)
dS1 / dr1	Switch-on delay / switch-off delay for OUT1
dS2 / dr2	Switch-on delay / switch-off delay for OUT2
Loc	Locks sensor operation to prevent unintentional maladjustment. Can be reset on the unit.

## 7.2 Set-up and settings for water

For media other than water → 7.6 Low-flow adjustment (optional).

- ▶ Switch on the supply voltage.
- > All LEDs light and go out again step by step. During this time output OUT1 is closed (if configured as normally open). The unit is in the operating mode.
- ▶ Let the normal flow circulate in the installation.
- ▶ Check the display and determine further actions.

<b>1</b>		<p>The factory setting is suitable for the application.</p> <ul style="list-style-type: none"> <li>▶ For flow monitoring no further settings are required.</li> </ul>
----------	--	---

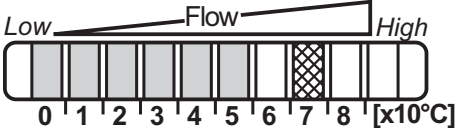
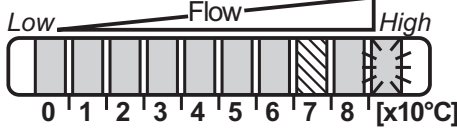
<p><b>2</b></p>		<p>Your normal flow is below the representation range of the display. 2 setting options:</p> <ul style="list-style-type: none"> <li>▶ Change the switch point (→ 7.3).</li> <li>▶ Carry out high-flow adjustment (→ 7.4).</li> </ul>
<p><b>3</b></p>		<p>Your normal flow exceeds the representation range of the display (LED 9 flashes). ▶ Carry out high-flow adjustment (→ 7.4).</p>

You can restore the factory setting any time (→ 7.8).



**UK**

### 7.3 Change switch point SP1 for flow (optional)

For the factory setting the switch point is at LED 7. A change makes sense in the following cases:

- the display shows example 2.
- the flow fluctuates much or pulsates.
- if a faster response time of the unit is requested (low switch point = fast response with rising flow, high switch point = fast response with falling flow).

Proceed as follows:

- ▶ Press the button  briefly.
- > The switch point LED flashes.
- ▶ Press  or  as often as required. Each press of the pushbutton shifts the LED by one position in the indicated direction.

 If no pushbutton is pressed for 2 s, the unit returns to the operating mode with the newly set value.

### 7.4 High-flow adjustment (optional)

The unit determines the existing flow as normal flow and adapts the display representation (all LEDs except the switch point LED light green).

Proceed as follows:

- ▶ Let the normal flow circulate in the installation.
- ▶ Press  and keep it pressed.
- > LED 9 lights, after approx. 5 s it flashes.
- ▶ Release the button.

The unit is now adapted to your flow conditions. It returns to the operating mode, the display should now show example 1.



The adjustment affects the switch point: it is increased proportionally (maximum up to LED 7).

## 7.5 Set switch point SP2 for temperature

▶ Press the button  briefly.

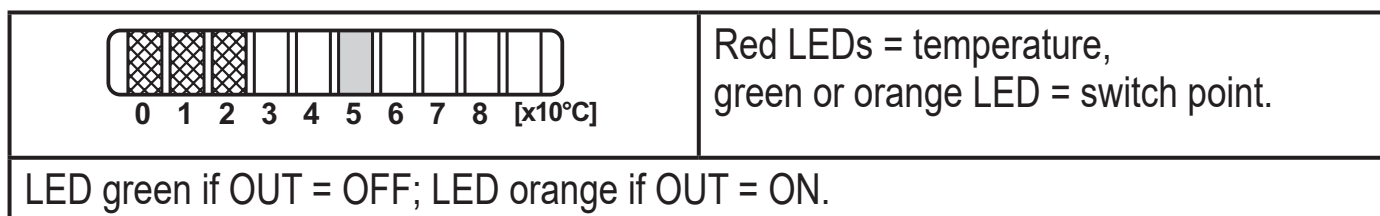

> The unit indicates the current temperature and the current setting of the switch point (SP2) in steps of 10 °C for approx. 5 s (→ 8.1).

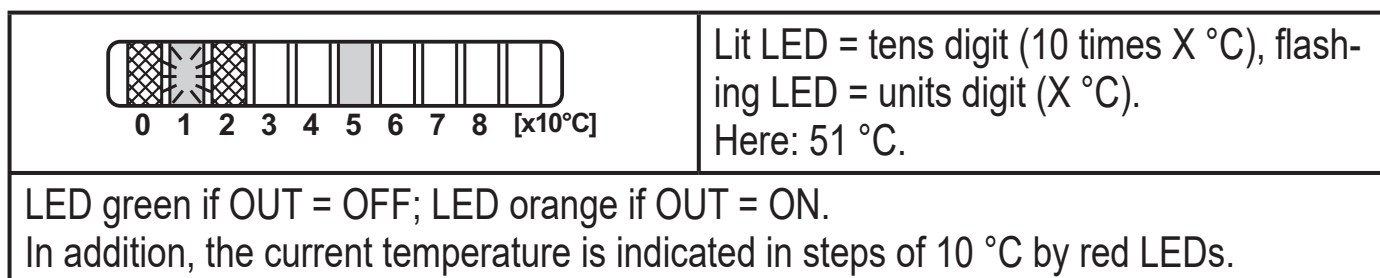

▶ Briefly press  again within 5 s.

> The current setting of the switch point is indicated in steps of 1 °C and can be changed.



▶ Press  or  as often as required. Each press of the pushbutton shifts the flashing LED (units digit) by one position in the indicated direction.



After LED 9 has been reached the cycle starts again at LED 0; the continuously lit LED (tens digit) moves one position to the right (when setting is made with ).

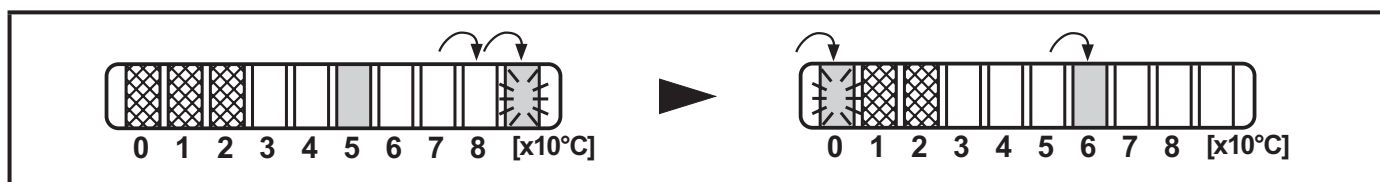

After LED 0 has been reached the cycle of the flashing LED starts again at LED 9; the continuously lit LED (tens digit) moves one position to the left (when setting is made with ).

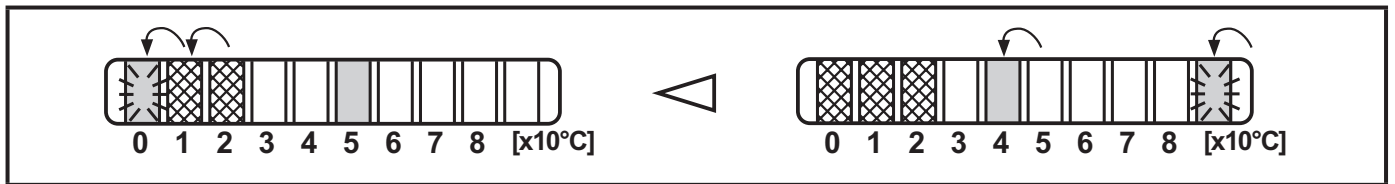

5 s after the last press of the pushbutton the display returns to the temperature and switch point display mode (step 1). After another 5 s the unit returns to the operating mode with the newly set value.

UK

## 7.6 Low-flow adjustment (optional)

If the unit is used in media other than water, you should additionally adapt the unit to the minimum flow.



The following adjustment must only be carried out after the high-flow adjustment.

Proceed as follows:

- ▶ Let the minimum flow circulate in the installation or ensure flow standstill.
- ▶ Press  and keep it pressed.
- > LED 0 lights, after approx. 5 s it flashes.
- ▶ Release the button. The unit adopts the new value and returns to the operating mode.

## 7.7 Configuration of the switching outputs (optional)

The unit is delivered as normally open. If necessary you can change the outputs to normally closed function. The setting applies to both outputs.

- ▶ Press  for at least 15 s.
- > LED 0 lights, after approx. 5 s it flashes.
- > After 10 s the current setting is displayed: LEDs 5...9 light orange (= outputs normally open).
- > After approx. 15 s LEDs 0...4 flash orange.
- ▶ Release the button. The outputs are changed to normally closed function.

For a new changeover: repeat the operation.



Using an IO-Link capable parameter setting tool, the outputs can be separately set as normally closed or normally open.

## 7.8 Restore the factory setting (reset)

- ▶ Press  for at least 15 s.
- > LED 9 lights, after approx. 5 s it flashes.
- > After approx. 15 s LEDs 0...9 flash orange.
- ▶ Release the button. All settings are reset to the factory setting:
  - operating range: 5 ...100 cm/s for water
  - switch point SP1 (flow): LED 7
  - switch point SP2 (temperature): LED 0 (4 °C)
  - output function: NO
  - not locked.

## 7.9 Lock / unlock the unit

The unit can be locked electronically to prevent unintentional settings.

- ▶ Press both setting buttons simultaneously for 10 s in the operating mode.
- > The indication goes out, the unit locks or unlocks.

On delivery: not locked.

## 7.10 Switch-on / switch-off delay

The unit features an internal switch-on / switch-off delay. This serves to delay the release of the outputs (OUT1, OUT2) for a set time (0...60 seconds).



This function requires a parameter setting software and cannot be set directly on the unit.

## 8 Operation

After every power on all LEDs light and go out again step by step (during this time the outputs are closed if configured as normally open). The unit is then ready for operation.

In case of power failure or interruption all settings remain.

### 8.1 Display current temperature and switch point SP2

► Press the button  briefly.

> The unit indicates the current temperature and the current setting of the switch point (SP2) in steps of 10 °C for approx. 5 s.

UK

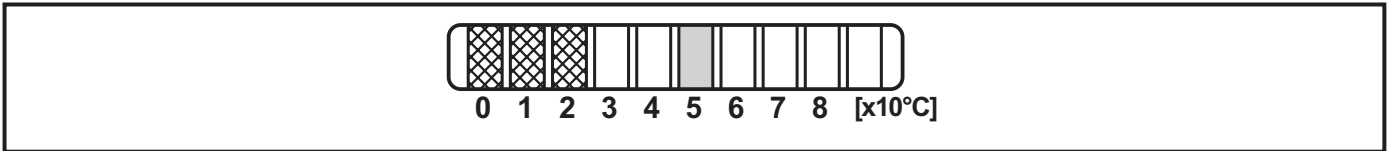

Row of LEDs red = current temperature T in °C.

LED	0	0...1	0...2	0...3	...	0...9
T	0...9	10...19	20...29	30...39	...	90...99

LED green or orange = current switch point SP2 in °C

LED	0	1	2	3	4	5	6	7	8	9
SP2	2...4	5...14	15...24	25...34	35...44	45...54	55...64	65...74	75...80	---

LED green if OUT = OFF; LED orange if OUT = ON

### 8.2 Operating indicators

	<p>Green LED bar: current flow within the display range.            Indication of the switch point flow (SP1):            - LED orange: output closed.            - LED red: output open.</p>
	<p>LED 9 flashes: current flow above the representation range.</p>
	<p>LED 0 flashes: current flow far below the display range.</p>

## 8.3 Interference indicators

	<p>Short circuit at switching output OUT1. The operating indicator and 5 red LEDs on the left light alternately.</p> <p>If the short circuit has been rectified, the unit immediately passes into the normal operating state. The current operating state is displayed.</p>
	<p>Short circuit at switching output OUT2. The operating indicator and 5 red LEDs on the right light alternately.</p> <p>If the short circuit has been rectified, the unit immediately passes into the normal operating state. The current operating state is displayed.</p>
<p>Display OFF (no LED lights):</p>	<p>Operating voltage too low (&lt; 19 V) or failed. Ensure a correct voltage supply.</p>
<p>Display briefly OFF (LEDs go off when a button is pressed)</p>	<p>The active LEDs go off briefly when a button is pressed if</p> <ul style="list-style-type: none"> <li>- an IO-Link communication is active (temporary locking)</li> <li>- or the sensor is permanently locked (→ 7.9).</li> </ul> <p>After approx. 0.6 seconds the last operating state is displayed.</p>

## 9 Troubleshooting

If high-flow adjustment (→ 7.3) or low-flow adjustment (→ 7.6) is not possible, all LEDs flash red. The unit then returns to the operating mode with unchanged values.

Possible causes	Corrective measures
Error during installation of the flow sensor.	▶ Read chapter → 4 Installation. Check whether all requirements have been met.
The difference between maximum flow and minimum flow is too small.	▶ Increase the flow difference and carry out the adjustment again.
The sequence high-flow / low-flow adjustment was not adhered to.	▶ Carry out the two adjustment operations again in the right sequence.



## 10 Maintenance

Recommended maintenance:

- ▶ Check the sensor tip for build-up from time to time.
- ▶ Clean it using a soft cloth. Stubborn build-up (e.g. lime) can be removed using a common vinegar cleaning agent.

## 11 Technical data

Technical data and scale drawing at [www.ifm.com](http://www.ifm.com).

UK

More information at [www.ifm.com](http://www.ifm.com)