

Operating instructions
Diffuse reflection sensor with
background suppression
and IO-Link
O8H2

UK

706432 / 00 08 / 2022

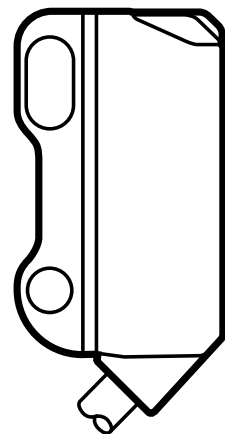

Content

1 Preliminary note.....	3
1.1 Symbols used	3
2 Functions and features	3
3 Installation.....	3
4 Operating and display elements	4
5 Electrical connection.....	4
5.1 PNP	4
5.2 NPN	5
6 Setting the range	5
6.1 Setting the range by means of background and object	5
6.2 Setting the range by means of the background.....	6
6.3 Setting the maximum range.....	7
7 IO-Link	8
7.1 General information	8
7.2 Device-specific information.....	8
7.3 Parameter setting tools.....	8
7.4 Setting parameters via IO-Link	8
8 Operation	9
9 Maintenance, repair, disposal.....	9

1 Preliminary note

1.1 Symbols used

- ▶ Instruction
- > Reaction, result
- [...] Designation of pushbuttons, buttons or indications
- Cross-reference



Important note

Non-compliance can result in malfunctions or interference.

UK

2 Functions and features

The diffuse reflection sensor detects objects and materials without contact and indicates their presence by a switching signal.

3 Installation

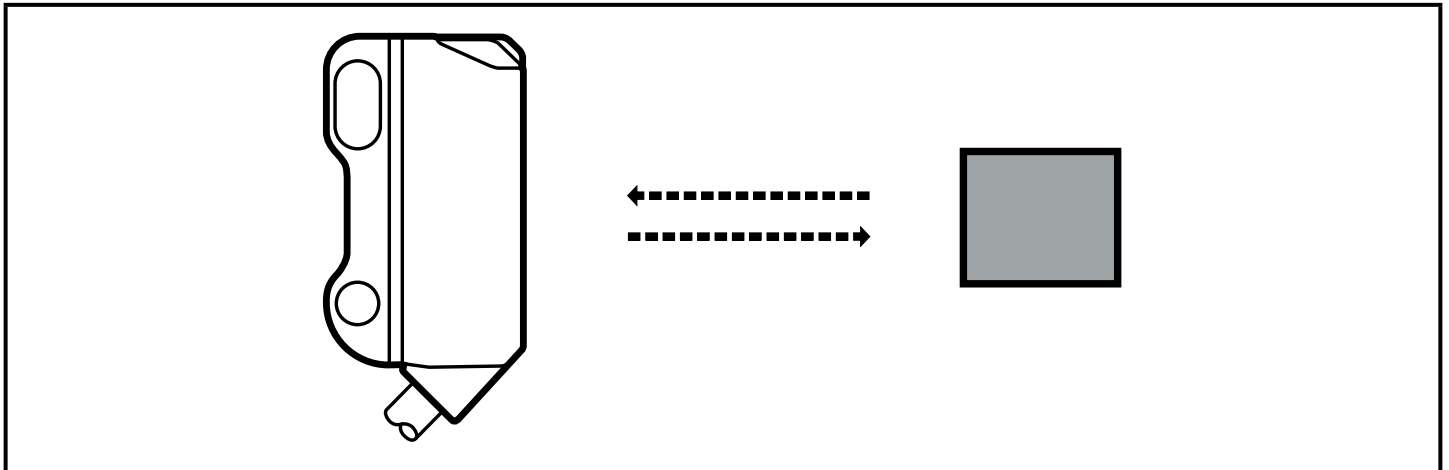

- ▶ Secure it to a bracket.
- ▶ Align the diffuse reflection sensor to the object to be detected.



Mount the diffuse reflection sensor with a tightening torque of max. 1 Nm.

Note:

The objects to be detected are to move transversely to the lens of the sensor.

- ▶ In case of other directions of movement it should be tested before whether safe switching is guaranteed.

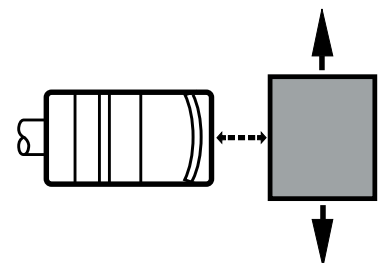

4 Operating and display elements

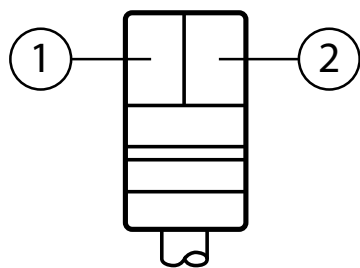

- 1: LED yellow - switching output active
- 2: LED green - operation

5 Electrical connection



The unit must be connected by a qualified electrician.

- ▶ The national and international regulations for the installation of electrical equipment must be adhered to.
- ▶ Ensure voltage supply to EN 50178.
- ▶ Disconnect power.
- ▶ Connect the unit as follows:

5.1 PNP

Cable *

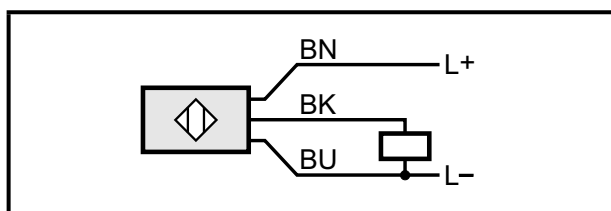

Connector M8 3-pin pigtail

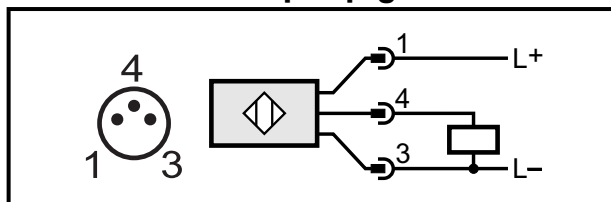

Connector M8 4-pin pigtail

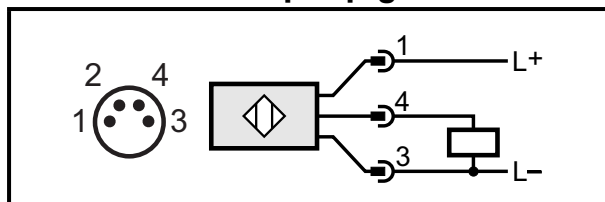

* Core colours: BN = brown, BU = blue, BK = black

5.2 NPN

Cable *

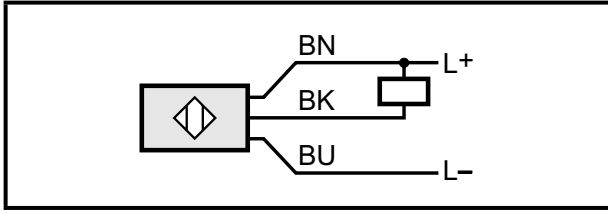

Connector M8 3-pin pigtail

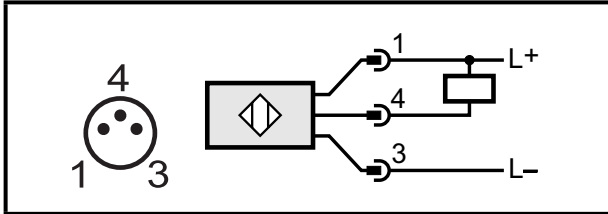

Connector M8 4-pin pigtail

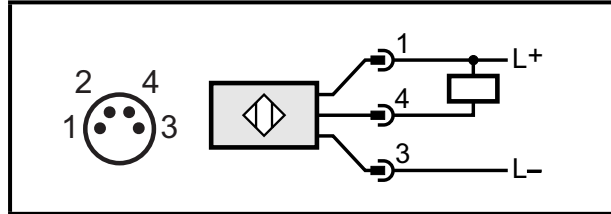

* Core colours: BN = brown, BU = blue, BK = black

6 Setting the range



The settings indicated in this chapter only apply to IO-Link capable PNP diffuse reflection sensors.

6.1 Setting the range by means of background and object

1. Start the parameter setting software (e.g. moneo configure SA).
2. Select [Parameter] > [Teach].
3. Align the diffuse reflection sensor to the object.

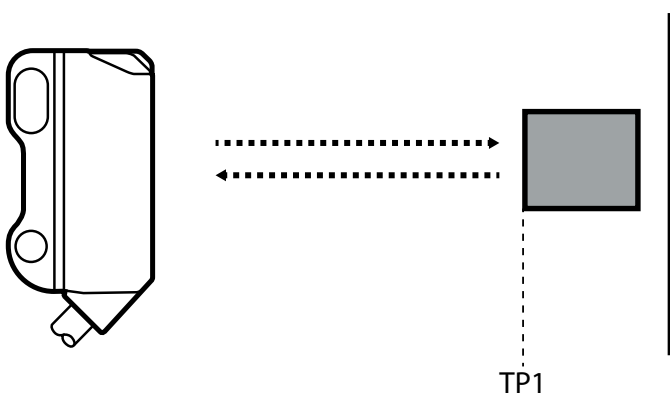

TP1: teach point 1

4. Click on the [Teach SP1 TP1] button in the parameter setting software.

5. Align the diffuse reflection sensor to the background.

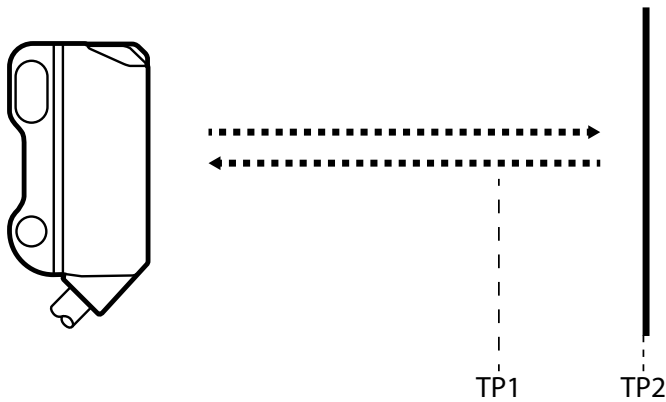

TP1: teach point 1

TP2: teach point 2

6. Click on the [Teach SP1 TP2] button in the parameter setting software.

> The switch point SP1 is between object and background.

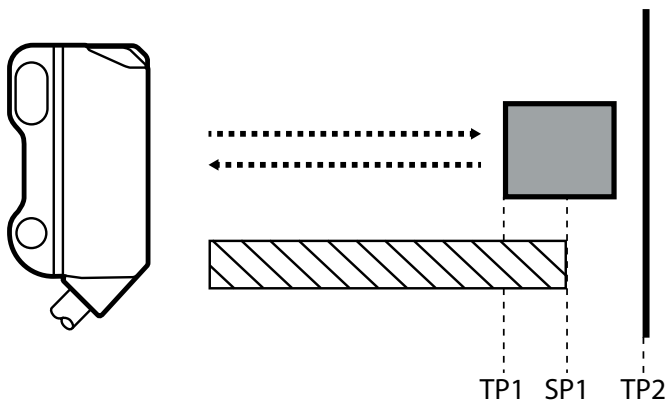

 Zone „object recognised“



Either the object can be set first and then the background, or the other way around.

6.2 Setting the range by means of the background

If the object is not available, the range can be set using only the background.



The switching characteristics of the diffuse reflection sensor are the most reliable if the range is set using the background and the object.

1. Start the parameter setting software (e.g. moneo configure SA).

2. Select [Parameter] > [Teach].

3. Align the diffuse reflection sensor to the background.

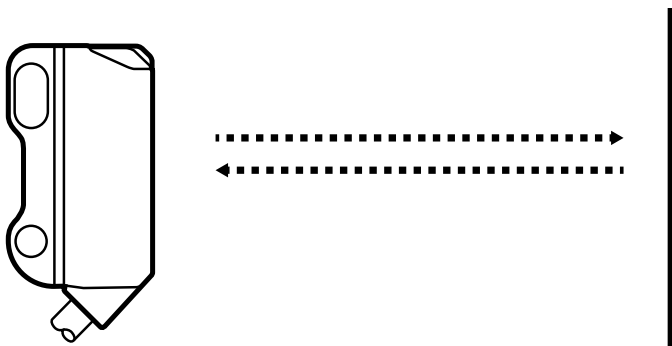

4. Click on the [Teach Custom - SP1 without target] button in the parameter setting software.

> The switch point SP1 is just in front of the background.

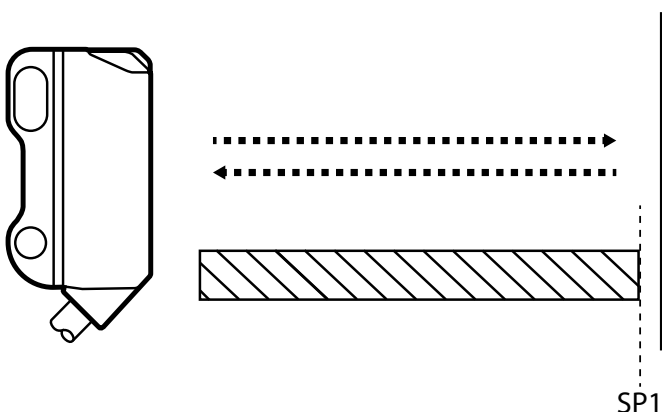

 Zone „object recognised“

6.3 Setting the maximum range

1. Start the parameter setting software (e.g. moneo configure SA).

2. Select [Parameter] > [Teach].

3. Align the diffuse reflection sensor to an empty area without object or background.

> The diffuse reflection sensor must not receive any light from the object or the background.

4. Click on the [Teach Custom - SP1 without target] button in the parameter setting software.

7 IO-Link

7.1 General information

This unit has an IO-Link communication interface which requires an IO-Link-capable module (IO-Link master) for operation. The IO-Link interface enables direct access to the sensor values and parameters and provides the possibility to set the parameters of the unit during operation. In addition communication is possible via a point-to-point connection with a USB adapter cable.

You will find more detailed information about IO-Link at www.ifm.com/uk/io-link.

7.2 Device-specific information

You will find the IODDs necessary for the configuration of the IO-Link device and detailed information about sensor values, diagnostic information and parameters in the overview table at www.ifm.com/uk/io-link.

7.3 Parameter setting tools

You will find all necessary information about the required IO-Link hardware and parameter setting software (e.g. moneo configure SA) at www.ifm.com/uk/io-link.

7.4 Setting parameters via IO-Link

Among others, the following parameters can be set via IO-Link.



A table of all adjustable parameters can be found at www.ifm.com/uk/io-link.

IO-Link parameter name	Parameter
SSC1 Param.SP1	Target value range
SSC1 Config.Logic	Switch point logic / status for the detected object High active: light-on mode - normally open Low active: dark-on mode - normally closed (→ 8 Operation)
SSC1 Switch-On delay	Switch-on delay
SSC1 Switch-Off delay	Switch-off delay
Transmitter configuration	Transmitted light ON / OFF
Sequence modulation	Anti-crosstalk function ON / OFF
Teach SP1 TP1 / Teach SP1 TP2	Setting the range by means of object and background

IO-Link parameter name	Parameter
Teach Custom – SP1 without target	Setting the range by means of the background

8 Operation

- ▶ Check whether the unit operates correctly.
- > The green LED is lit when the supply voltage is applied and the sensor signal is stable.
- > Dark-on mode - normally closed: the output is switched / the yellow LED is lit when no object is detected.
- > Light-on mode - normally open: the output is switched / the yellow LED is lit when an object is detected.

UK

9 Maintenance, repair, disposal

- ▶ Keep the lens of the sensor free from soiling.
- ▶ For cleaning do not use any solvents or cleaning agents which could damage the plastic parts.
- ▶ After use dispose of the unit in an environmentally friendly way in accordance with the applicable national regulations.

Faulty sensors must only be repaired by the manufacturer.

Technical data and further information at www.ifm.com