

IR06S-PS150-RA12

Mind O≠0, I≠I≠1, S≠5, B≠8.

Ring diameter	∅ 6.1 mm
Resolution	adjustable, ∅ >0.5mm
Operating voltage	10...30 V _{DC}
Reverse polarity protection	built-in
Current consumption	<10 mA
Current load capability	200 mA
Output function	NO NC
Output polarity	PNP
Short circuit protection	built-in, self-resetting
Impulse lengthening	0.1...150 ms
Voltage drop	<2 V @ 200 mA
Adjustment	multi-turn potentiometer
Object speed	0.1...35 m/s · 0.33...115 ft/s
Response release time	0.2 ms 0.2 ms
Operating temperature	-20...+70 °C · -3...+159 °F
Protection class	IP67
Ring material	PA 6,6
Housing material	PBT
Switching indicator	built-in
Connection	male connector M12
Complies with	CE, RoHS



25 months Warranty Our products are manufactured to stringent ISO 9001 European standards to ensure that our customers only receive the best quality.

Inductive Proximity Switch 3-Wire Ring Sensors Operating principle: *Static*

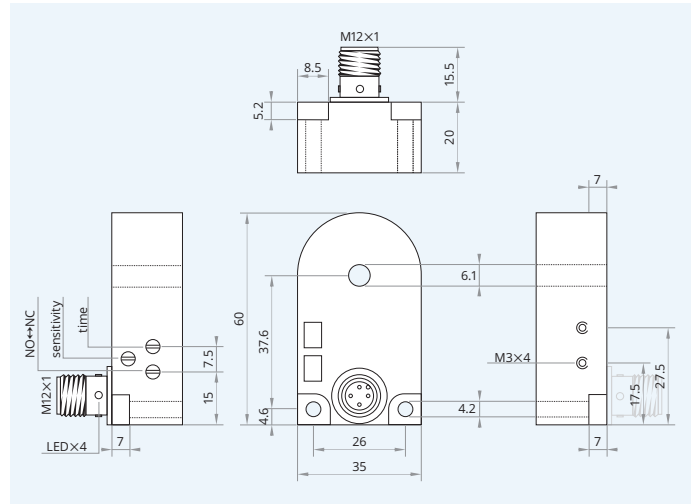

Wiring diagram

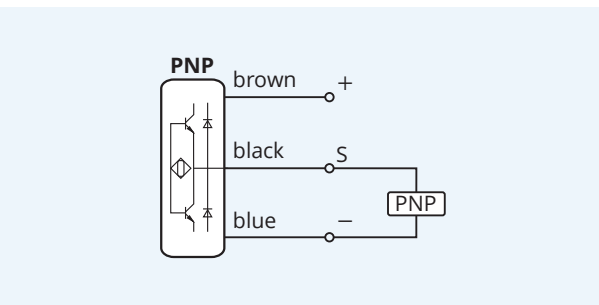

Pinout

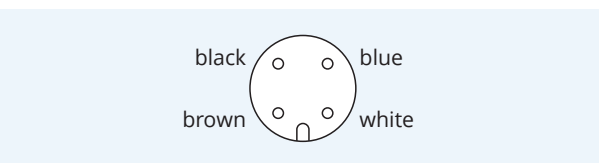

Caution! This device shall not be used if the safety of persons rely on its faultless function.

XECRO reserves the right to make minor changes without prior notification.