

IR06S-NC-RA12

Mind O≠0, I≠I≠1, S≠5, B≠8.

Ring diameter	∅ 6.1 mm
Resolution	adjustable, ∅ >1 mm
Operating voltage	10...30 V _{DC}
Reverse polarity protection	built-in
Current consumption	<10 mA
Current load capability	200 mA
Output function	normally closed
Output polarity	NPN
Short circuit protection	built-in, self-resetting
Voltage drop	<2 V @ 200 mA
Adjustment	multi-turn potentiometer
Object speed	≤35 m/s · ≤115 ft/s
Response release time	0.5 ms 10 ms
Operating temperature	-20...+70 °C · -3...+159 °F
Protection class	IP67
Ring material	PA 6,6
Housing material	PBT
Switching indicator	built-in
Connection	male connector M12
Complies with	CE, RoHS



Inductive Proximity Switch 3-Wire Ring Sensors Operating principle: *Static*

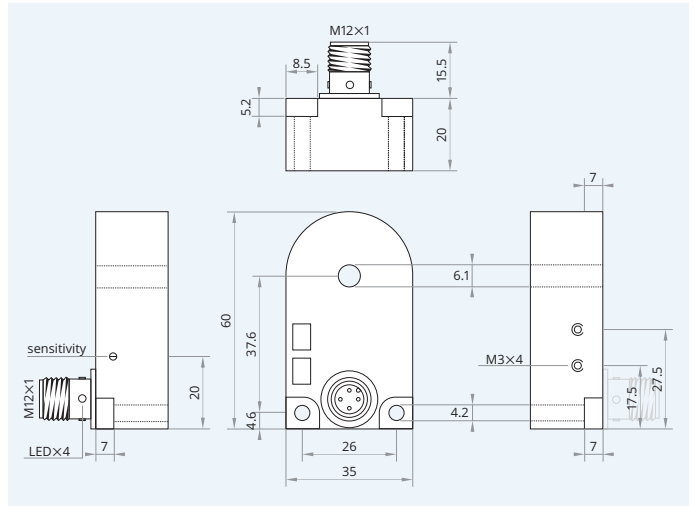

25 months **Warranty** Our products are manufactured to stringent ISO 9001 European standards to ensure that our customers only receive the best quality.

Wiring diagram

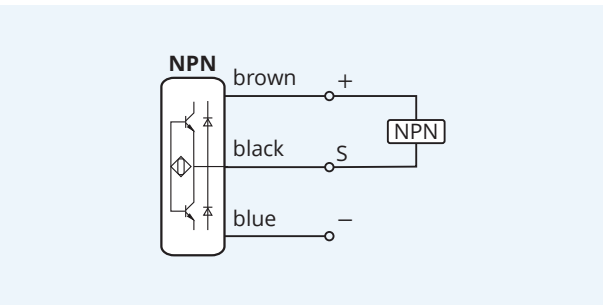

Pinout

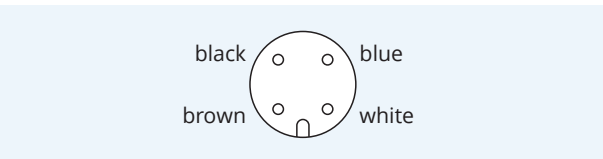

⚠ Caution! This device shall not be used if the safety of persons rely on its faultless function.

XECRO reserves the right to make minor changes without prior notification.