

IPS8-S1NO60-A8

Mind O≠0, I≠I≠1, S≠5, B≠8.

| | |
|-----------------------------|-------------------------------|
| Housing dimension | M8×1 |
| Mounting | flush |
| Sensing distance S_n | 1 mm |
| Operating voltage | 10...30 V _{DC} |
| Reverse polarity protection | built-in |
| Current consumption | <8 mA |
| Current load capability | 200 mA |
| Output function | normally open |
| Output polarity | NPN |
| Short circuit protection | built-in, self-resetting |
| Voltage drop | <1.5 V @ 200 mA |
| Switching frequency | 2000 Hz |
| Reduction factors | Alu 0.45 · Brs 0.50 · SS 0.85 |
| Operating temperature | -20...+70 °C · -3...+159 °F |
| Protection class | IP67 |
| Sensing face material | PBT |
| Housing material | SS304 |
| Switching indicator | built-in |
| Connection | male connector M8 |
| Complies with | CE, RoHS |



Inductive Proximity Switch 3-Wire DC Sensing range: *Standard*

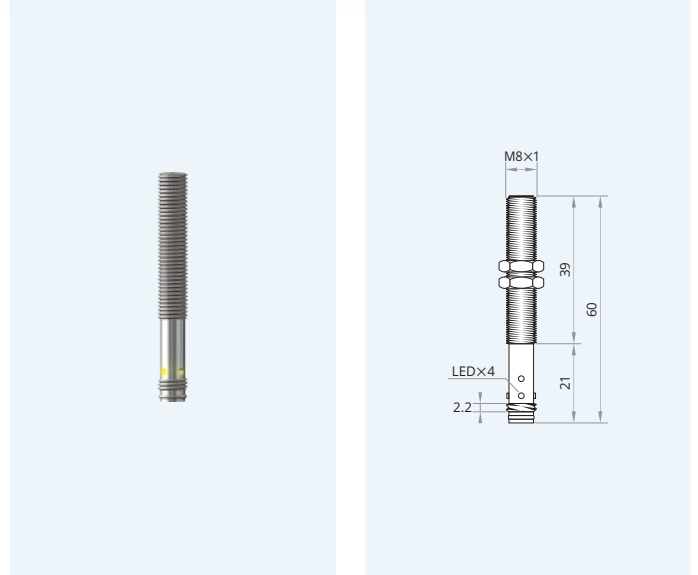

25 months **Warranty** Our products are manufactured to stringent ISO 9001 European standards to ensure that our customers only receive the best quality.

Wiring diagram



Clearance for parallel mounting

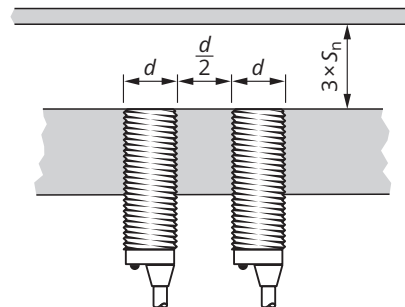

Clearance for opposing mounting



⚠ Caution! This device shall not be used if the safety of persons rely on its faultless function.

XECRO reserves the right to make minor changes without prior notification.