

## IPS18-S8PC55-A2P

Mind O≠0, I≠I≠1, S≠5, B≠8.

Housing dimension	M18×1
Mounting	flush
Sensing distance $S_n$	8 mm
Operating voltage	10...30 V <sub>DC</sub>
Reverse polarity protection	built-in
Current consumption	<8 mA
Current load capability	200 mA
Output function	normally closed
Output polarity	PNP
Short circuit protection	built-in, self-resetting
Voltage drop	<1.5 V @ 200 mA
Switching frequency	500 Hz
Reduction factors	Alu 0.45 · Brs 0.50 · SS 0.85
Operating temperature	-20...+70 °C · -3...+159 °F
Protection class	IP67
Sensing face material	PBT
Housing material	brass
Switching indicator	built-in
Connection	PVC, ultra-flex
Complies with	CE, RoHS



## Inductive Proximity Switch 3-Wire DC Sensing range: *Increased*

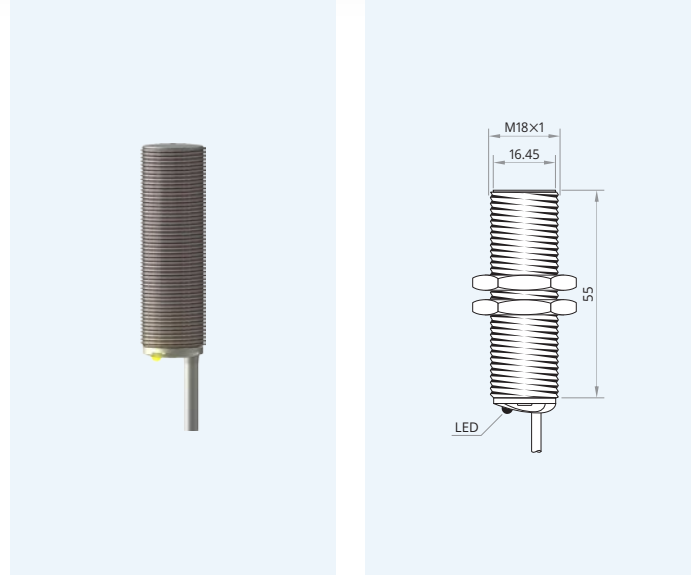

**25 months** **Warranty** Our products are manufactured to stringent ISO 9001 European standards to ensure that our customers only receive the best quality.

Wiring diagram



Clearance for parallel mounting



Clearance for opposing mounting



**⚠** Caution! This device shall not be used if the safety of persons rely on its faultless function.

XECRO reserves the right to make minor changes without prior notification.