

IPSD6-N6NO70-A12

Mind O≠0, I≠I≠1, S≠5, B≠8.

Housing dimension	∅ 6.5 mm
Mounting	non-flush
Sensing distance S_n	6 mm
Operating voltage	10...30 V _{DC}
Reverse polarity protection	built-in
Current consumption	<8 mA
Current load capability	200 mA
Output function	normally open
Output polarity	NPN
Short circuit protection	built-in, self-resetting
Voltage drop	<1.5 V @ 200 mA
Switching frequency	500 Hz
Reduction factors	Alu 0.45 · Brs 0.50 · SS 0.85
Operating temperature	-20...+70 °C · -3...+159 °F
Protection class	IP67
Sensing face material	PBT
Housing material	SS304
Switching indicator	built-in
Connection	male connector M12
Complies with	CE, RoHS



Inductive Proximity Switch 3-Wire DC Sensing range: *Extended*

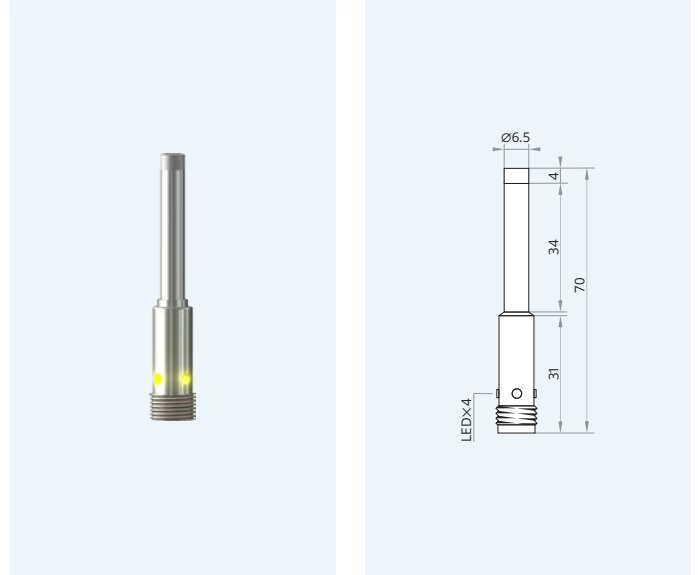

25 months **Warranty** Our products are manufactured to stringent ISO 9001 European standards to ensure that our customers only receive the best quality.

Wiring diagram



Clearance for parallel mounting



⚠ Caution! This device shall not be used if the safety of persons rely on its faultless function.

XECRO reserves the right to make minor changes without prior notification.