

IHT12-N8BPC50-N2S

Mind O≠0, I≠I≠1, S≠5, B≠8.

Housing dimension	M12×1
Mounting	non-flush
Sensing distance S_n	8 mm
Operating voltage	10...30 V _{DC}
Reverse polarity protection	built-in
Current consumption	<8 mA
Current load capability	120 mA
Output function	normally closed
Output polarity	PNP
Short circuit protection	built-in, self-resetting
Voltage drop	<2V @ 120 mA
Switching frequency	300 Hz
Reduction factors	Alu 0.45 · Brs 0.50 · VA 0.85
Operating temperature	-20...+150 °C · -3...+303 °F
Protection class	IP67
Sensing face material	PTFE
Housing material	SS 1.4301
Connection	silicone
Mounting clearance z	14 mm
Mounting clearance x	14 mm
Complies with	CE, RoHS



Warranty Our products are manufactured to stringent ISO 9001 European standards to ensure that our customers only receive the best quality.



Inductive Proximity Switch 3-Wire DC High Temperature Resistant Sensing range: *Standard*

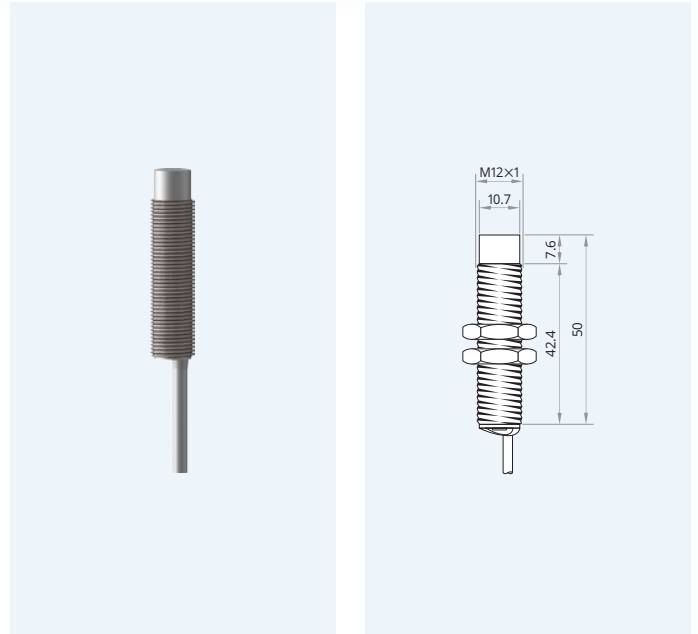

Maximum temperature: 150 °C · 303 °F

Wiring diagram

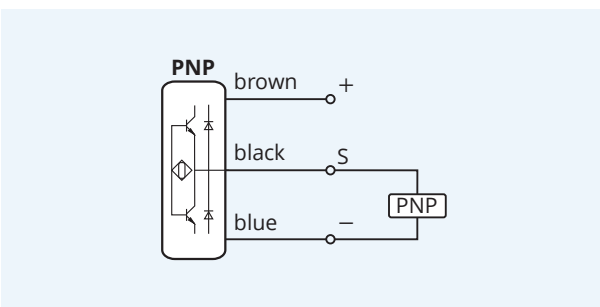

Clearance for parallel mounting



Caution! This device shall not be used if the safety of persons rely on its faultless function.

XECRO reserves the right to make minor changes without prior notification.