

IHT18-N8BNO55-A2S

Mind O≠0, I≠I≠1, S≠5, B≠8.

Housing dimension	M18×1
Mounting	non-flush
Sensing distance S_n	8 mm
Operating voltage	10...30 V _{DC}
Reverse polarity protection	built-in
Current consumption	<8 mA
Current load capability	150 mA
Output function	normally open
Output polarity	NPN
Short circuit protection	built-in, self-resetting
Voltage drop	<2V @ 150 mA
Switching frequency	500 Hz
Reduction factors	Alu 0.45 · Brs 0.50 · VA 0.85
Operating temperature	-20...+150 °C · -3...+303 °F
Protection class	IP67
Sensing face material	PTFE
Housing material	SS 1.4301
Switching indicator	built-in*
Connection	silicone
Mounting clearance z	24 mm
Mounting clearance x	20 mm
Complies with	CE, RoHS



Warranty Our products are manufactured to stringent ISO 9001 European standards to ensure that our customers only receive the best quality.



Inductive Proximity Switch 3-Wire DC High Temperature Resistant Sensing range: *Standard*

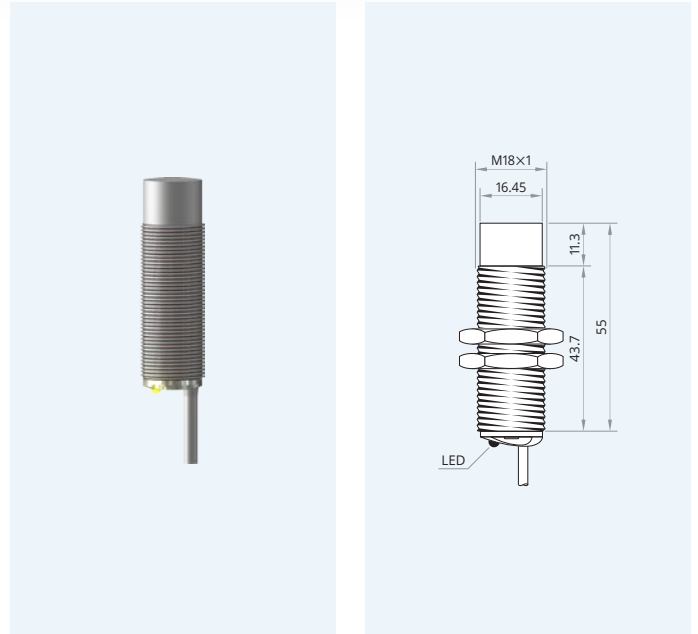

Maximum temperature: 150 °C · 303 °F

* Only for set-up. The LED may die if operated beyond 120 °C (249 °F). The LED is not covered by warranty.

Wiring diagram

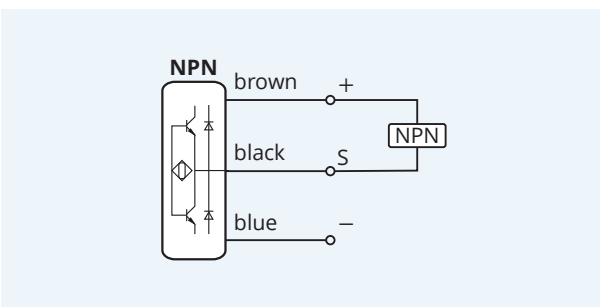

Clearance for parallel mounting

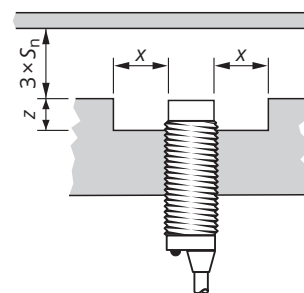

Caution! This device shall not be used if the safety of persons rely on its faultless function.

XECRO reserves the right to make minor changes without prior notification.