

IHP12-S1.5NO43-N2P

Mind O≠0, I≠I≠1, S≠5, B≠8.

Housing dimension	M12×1
Mounting	flush
Sensing distance S_n	1.5 mm
Operating voltage	10...30 V _{DC}
Reverse polarity protection	built-in
Current consumption	<8 mA
Current load capability	200 mA
Output function	normally open
Output polarity	NPN
Short circuit protection	built-in, self-resetting
Voltage drop	<1.5 V @ 200 mA
Switching frequency	1000 Hz
Reduction factors	Alu 0.45 · Brs 0.50 · SS 0.85
Operating temperature	-20...+70 °C · -3...+159 °F
Protection class	IP69k, IP67 connector
Sensing face material	ceramic
Housing material	SS 1.4301
Connection	PVC, ultra-flex
Complies with	CE, RoHS



Inductive Proximity Switch 3-Wire DC High Pressure Proof Sensing range: *Standard*

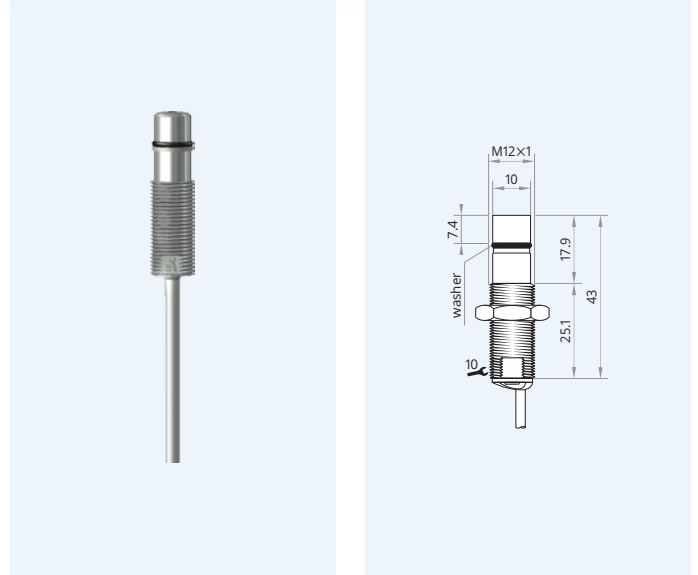

Maximum pressure: 500 bar · 7251 psi

25 months **Warranty** Our products are manufactured to stringent ISO 9001 European standards to ensure that our customers only receive the best quality.

Wiring diagram

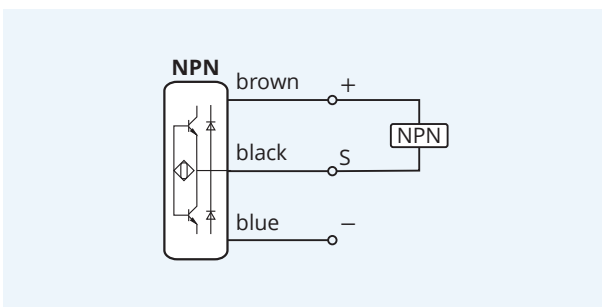

Clearance for parallel mounting

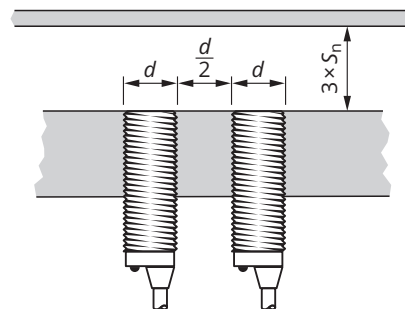

Clearance for opposing mounting



⚠ Caution! This device shall not be used if the safety of persons rely on its faultless function.

XECRO reserves the right to make minor changes without prior notification.