

IHP12-S1.5PC93-N12

Mind O≠0, I≠I≠1, S≠5, B≠8.

Housing dimension	M12×1
Mounting	flush
Sensing distance S_n	1.5 mm
Operating voltage	10...30 V _{DC}
Reverse polarity protection	built-in
Current consumption	<8 mA
Current load capability	200 mA
Output function	normally closed
Output polarity	PNP
Short circuit protection	built-in, self-resetting
Voltage drop	<1.5 V @ 200 mA
Switching frequency	1000 Hz
Reduction factors	Alu 0.45 · Brs 0.50 · SS 0.85
Operating temperature	-20...+70 °C · -3...+159 °F
Protection class	IP69k, IP67 connector
Sensing face material	ceramic
Housing material	SS 1.4301
Connection	male connector M12
Complies with	CE, RoHS



Inductive Proximity Switch 3-Wire DC High Pressure Proof Sensing range: *Standard*

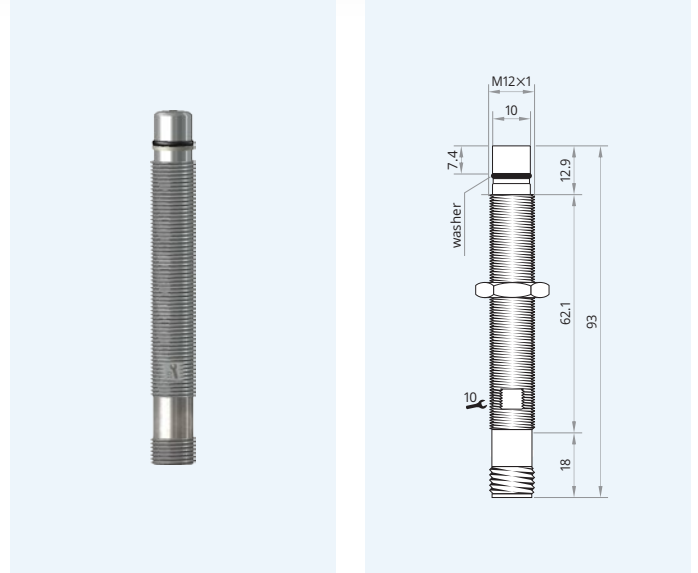

Maximum pressure: 500 bar · 7251 psi

25 months **Warranty** Our products are manufactured to stringent ISO 9001 European standards to ensure that our customers only receive the best quality.

Wiring diagram



Pinout

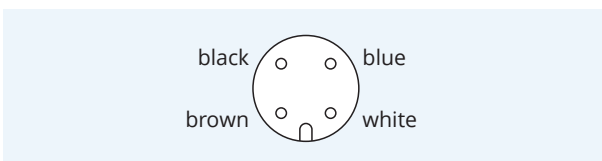

Clearance for parallel mounting



Clearance for opposing mounting



⚠ Caution! This device shall not be used if the safety of persons rely on its faultless function.

XECRO reserves the right to make minor changes without prior notification.