

HOUSING	OPERATING DISTANCE	MOUNTING	✓
M8	6 mm	Non-embeddable	

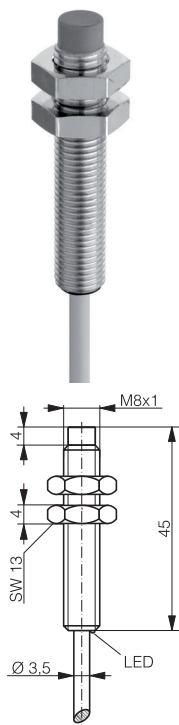

DW-AD-51x-M8

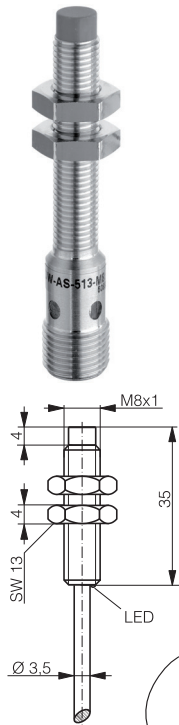

DW-AD-51x-M8-750

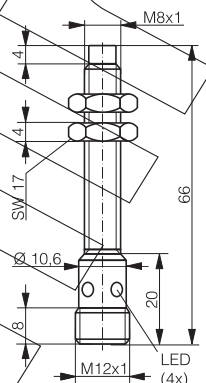
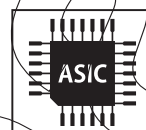

DW-AS-51x-M8

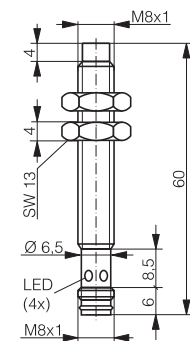

DW-AS-51x-M8-001

DETECTION DATA		INTERFACE	
Rated operating distance (S_n)	6 mm	Indicator LED, yellow	Sensing state ($0 \leq s \leq 0.8 S_r$)
Assured operating distance (S_a)	$\leq (0.81 \times S_n)$ mm	Indicator LED, yellow, blinking	Sensing state ($0.8 S_r < s \leq S_r$)
Repeat accuracy	0.3	IO-Link	✓
Hysteresis	$\leq 20\% S_r$		
Temperature drift	$\leq 10\% S_r$		
Standard target	18 x 18 x 1 mm, FE360		

Note: $0.9S_n \leq S_a \leq 1.1S_n$.

ELECTRICAL DATA		MECHANICAL DATA	
Supply voltage range (U_B)	10...30 VDC	Mounting	Non-embeddable
Residual ripple	$\leq 20\% U_B$	Housing material	Chrome-plated brass
Output current	200	Sensing face material	PBTP
Output voltage drop	≤ 2.0 VDC	Max tightening torque	4
Power consumption (no-load)	≤ 10 mA	Ambient operating temperature	-25...+70°C
Residual current	≤ 0.1 mA	Enclosure rating	IP 67
Switching frequency	500	Weight (cable / connector)	see page 2
Short-circuit protection	✓	Shock and vibration	IEC 60947-5-2 / 7.4
Voltage reversal protection	✓		
Cable length max.	300 m		

Note: all data measured according to IEC 60947-5-2 standard with $U_B=20...30$ VDC, $T_A=23$ °C \pm 5 °C.

CORRECTION FACTORS

Steel FE 360	1	Copper	0.44	Aluminum	0.47	Brass	0.55	Stainless S. V2A 1 / 2 mm	0.77
--------------	---	--------	------	----------	------	-------	------	---------------------------	------

Note: the operating distance of the sensor must be multiplied by the correction factor of the material. For example, the operating distance on Aluminum is $S_{n,Al} = S_n \times CF_{Al}$. In case of embeddable mounting, the distance is multiplied by the additional correction factor of the support, thus $S_{n,Al} = S_n \times CF_{Al} \times CF_{emb,Al}$.

INSTALLATION CONDITIONS

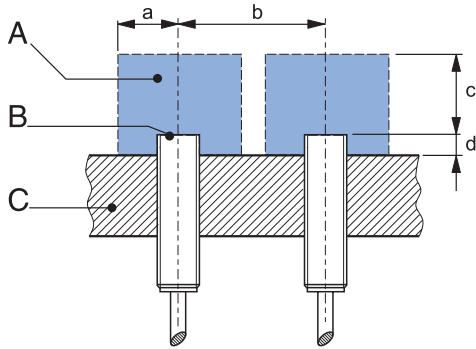

A : metal free zone a : 12 mm d : steel 10 mm
 B : sensing face b : 30 mm
 C : support c : 18 mm

IO-LINK FUNCTIONALITIES

IO-Link version	1.1
SIO mode	Supported
Process data	7-bit input
Baudrate	COM2 (38.4 kBaud)
Minimum cycle time	10.4 ms
ISDU	Not supported

IODD files may be downloaded from www.contrinx.com
 (DW-Ax-51x-M8 product pages or by scanning the QR code on the left)

Note: additional installation information can be found in the glossary of the Contrinex General Catalog.

WIRING DIAGRAM

PIN ASSIGNMENT

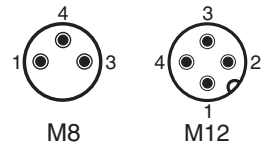
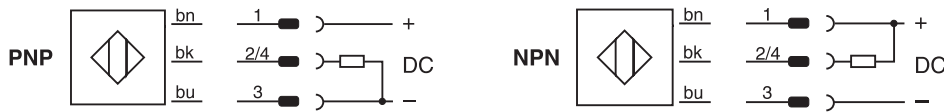

AVAILABLE TYPES

Part number	Part reference	Polarity	Connection	Output on pin 2	Output on pin 4	Weight
330-020-048	DW-AD-511-M8	NPN	PVC, 2 m, 3 wire	-	Normally open (NO)	45 g
330-020-050	DW-AD-512-M8	NPN	PVC, 2 m, 3 wire	-	Normally close (NC)	45 g
330-020-051	DW-AD-513-M8	PNP	PVC, 2 m, 3 wire	-	Normally open (NO) / IO-Link	45 g
330-020-054	DW-AD-514-M8	PNP	PVC, 2 m, 3 wire	-	Normally close (NC)	45 g
330-020-061	DW-AD-511-M8-750	NPN	PVC, 2 m, 3 wire	-	Normally open (NO)	42 g
330-020-062	DW-AD-513-M8-750	PNP	PVC, 2 m, 3 wire	-	Normally open (NO) / IO-Link	42 g
330-020-080	DW-AS-511-M8	NPN	M12 4-pin	-	Normally open (NO)	20 g
330-020-081	DW-AS-511-M8-001	NPN	M8 3-pin	-	Normally open (NO)	17 g
330-020-082	DW-AS-512-M8	NPN	M12 4-pin	-	Normally close (NC)	20 g
330-020-083	DW-AS-512-M8-001	NPN	M8 3-pin	-	Normally close (NC)	17 g
330-020-084	DW-AS-513-M8	PNP	M12 4-pin	-	Normally open (NO) / IO-Link	20 g
330-020-085	DW-AS-513-M8-001	PNP	M8 3-pin	-	Normally open (NO) / IO-Link	17 g
330-020-086	DW-AS-514-M8	PNP	M12 4-pin	-	Normally close (NC)	20 g
330-020-087	DW-AS-514-M8-001	PNP	M8 3-pin	-	Normally close (NC)	17 g

Note: part reference may include additional suffix to indicate a revision version or special version. Further information is available on request.

Operators of the products we supply are responsible for compliance with measures for the protection of persons. The use of our equipment in applications where the safety of persons might be at risk is only authorized if the operator observes and implements separate, appropriate and necessary measures for the protection of persons and machines. Terms of delivery and rights to change design reserved.