



Model Number

UBE800-F77-SE2-V31

Through-beam ultrasonic barrier

Features

- Miniature design
- Highly visible LEDs for Power ON and switching state
- High switching frequency
- Program input
- Degree of protection IP67

Technical data

General specifications

Sensing range	0 ... 800 mm emitter/receiver spacing
Standard target plate	see table
Transducer frequency	approx. 300 kHz

Nominal ratings

Time delay before availability t_v	≤ 150 ms
--------------------------------------	----------

Limit data

Permissible cable length	max. 300 m
--------------------------	------------

Indicators/operating means

LED green	Power on (emitter)
LED yellow	switching state (receiver)

Electrical specifications

Rated operating voltage U_e	24 V DC
Operating voltage U_B	20 ... 30 V DC , ripple 10 % _{SS} ; 12 ... 20 V DC sensitivity reduced to 80 %
No-load supply current I_0	≤ 20 mA

Input

Input type	1 program input (receiver)
Level	low level : 0 ... 0.7 V ; high level : > 14 V
Input impedance	16 kΩ
Pulse length	≥ 3 s

Output

Output type	1 switch output PNP, NO
Rated operating current I_e	200 mA , short-circuit/overload protected
Voltage drop U_d	≤ 2 V
Switch-on delay t_{on}	≤ 5 ms
Switching frequency f	100 Hz
Off-state current I_r	≤ 0.01 mA

Ambient conditions

Ambient temperature	-25 ... 70 °C (-13 ... 158 °F)
Storage temperature	-40 ... 85 °C (-40 ... 185 °F)
Shock resistance	30 g , 11 ms period
Vibration resistance	10 ... 55 Hz , Amplitude ± 1 mm

Mechanical specifications

Connection type	M8 x 1 connector , 4-pin
Degree of protection	IP67
Material	
Housing	Polycarbonate
Transducer	epoxy resin/hollow glass sphere mixture; polyurethane foam
Installation position	any position
Mass	Per 10 g
Tightening torque, fastening screws	max. 0.2 Nm

Compliance with standards and directives

Standard conformity	
Standards	EN 60947-5-2:2007+A1:2012 IEC 60947-5-2:2007 + A1:2012

Approvals and certificates

UL approval	cULus Listed, General Purpose
CCC approval	CCC approval / marking not required for products rated ≤36 V

Safety Note



The use of this device in applications, where the safety of persons depends from the devices function, is not allowed!

Dimensions

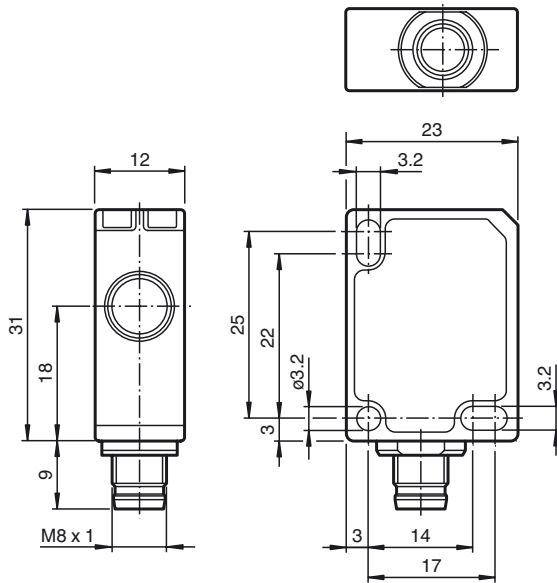

Description of Sensor Function

An ultrasonic thru-beam sensor always consists of an ultrasonic emitter and receiver. The working principle of the ultrasonic thru-beam sensor is based on the interruption of the transmission from the emitter to the receiver by the object to be detected (obstacle).

The emitter produces an ultrasonic signal which is evaluated by the receiver. If the signal is damped or broken by the object being detected, the receiver switches state.

No electrical connections are required between the emitter and receiver.

Sensitivity adjustment

The sensitivity is adjusted using the input ET. This can be open or connected using +U_B or -U_B.

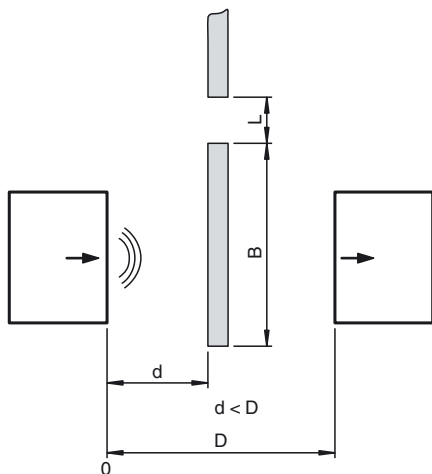

ET	Sensitivity	D	B ⁽¹⁾	L ⁽¹⁾
Open	High	≤ 800 mm	≥ 50 mm	≥ 15 mm
-U _B	Medium	≤ 600 mm	≥ 40 mm	≥ 10 mm
+U _B	Low	≤ 400 mm	≥ 30 mm	≥ 5 mm

(1) The specified values for B and L are reference values and refer to the maximum distance D and to objects with a rectangular shape. The shape of the objects can have an effect on the values for B and L.



Safety Note



The use of this device in applications, where the safety of persons depends from the devices function, is not allowed!

Release date: 2018-12-19 12:36 Date of issue: 2018-12-19 233248_eng.xml

Refer to "General Notes Relating to Pepperl+Fuchs Product Information".

Pepperl+Fuchs Group
www.pepperl-fuchs.com

USA: +1 330 486 0001
fa-info@us.pepperl-fuchs.com

Germany: +49 621 776 1111
fa-info@de.pepperl-fuchs.com

Singapore: +65 6779 9091
fa-info@sg.pepperl-fuchs.com