



Model Number

UB800-F12-U-V15

Single head system

Features

- Evaluation limits can be taught-in
- Selectable sound lobe width
- Synchronization options
- Very small unusable area
- Temperature compensation

Diagrams

Characteristic response curve

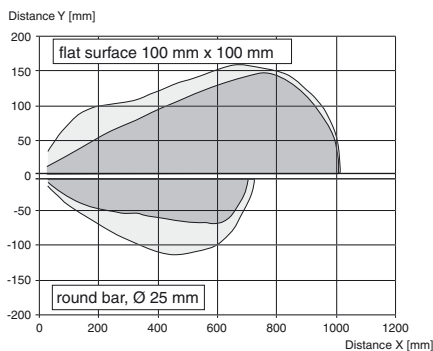

Technical data

General specifications	
Sensing range	30 ... 800 mm
Adjustment range	50 ... 800 mm
Dead band	0 ... 30 mm
Standard target plate	100 mm x 100 mm
Transducer frequency	approx. 310 kHz
Response delay	approx. 100 ms
Indicators/operating means	
LED green	Operating display
LED yellow	Evaluation range indicator, Ready for programming
LED red	Ready for programming, Fault
Electrical specifications	
Operating voltage U_B	12 ... 30 V DC
No-load supply current I_0	≤ 30 mA
Input/Output	
Synchronization	1 synchronous connection, bi-directional 0-level: $-U_B \dots +1$ V 1-level: $+4$ V ... $+U_B$ input impedance: > 12 kΩ synchronization pulse: ≥ 100 μs, synchronization interpulse period: ≥ 2 ms
Synchronization frequency	
Common mode operation	≤ 45 Hz
Multiplex operation	≤ 45/n Hz, n = number of sensors
Input	
Input type	1 program input Switching distance 1: $-U_B \dots +1$ V, Switching distance 2: $+3$ V ... $+U_B$ Input impedance: > 10 kΩ
Pulse length	≥ 1 s
Output	
Output type	1 analog output 0 ... 10 V
Default setting	evaluation limit A1: 50 mm, evaluation limit A2: 800 mm, wide sound lobe, rising ramp
Repeat accuracy	≤ 1 %
Load impedance	≥ 500 Ohm
Temperature influence	± 1.5 % of full-scale value
Ambient conditions	
Ambient temperature	-15 ... 70 °C (5 ... 158 °F)
Storage temperature	-40 ... 85 °C (-40 ... 185 °F)
Mechanical specifications	
Connection type	Connector plug M12 x 1, 5-pin
Degree of protection	IP54
Material	
Housing	Frame: nickel plated, die cast zinc, Laterals: glass-fiber reinforced plastic PC
Transducer	epoxy resin/hollow glass sphere mixture; foam polyurethane, cover PBT
Mass	60 g
Compliance with standards and directives	
Standard conformity	
Standards	EN 60947-5-2:2007+A1:2012 IEC 60947-5-2:2007 + A1:2012 EN 60947-5-7:2003 IEC 60947-5-7:2003
Approvals and certificates	
UL approval	cULus Listed, General Purpose
CSA approval	cCSAus Listed, General Purpose
CCC approval	CCC approval / marking not required for products rated ≤36 V

Release date: 2016-04-25 09:25 Date of issue: 2019-01-25 202088_eng.xml

Dimensions

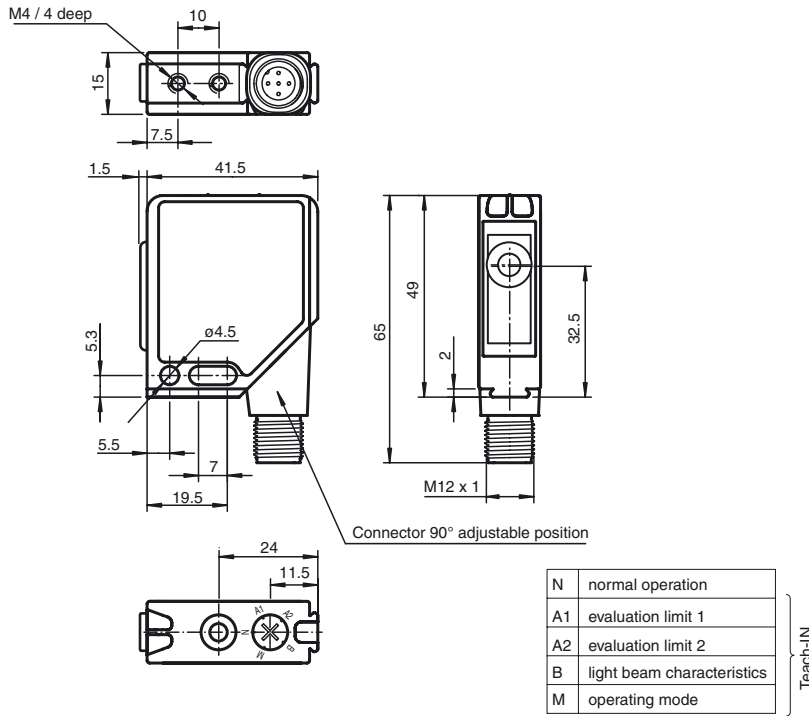

Additional Information

Analogue output programming

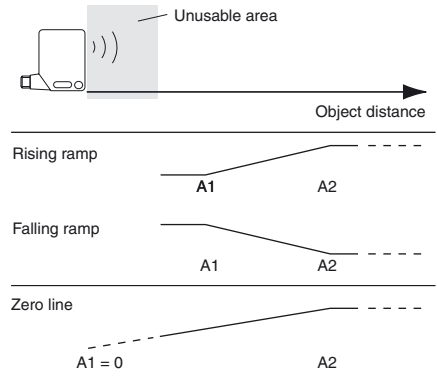

Electrical Connection

Standard symbol/Connections:
(version U)

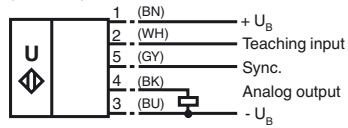

Core colours in accordance with EN 60947-5-2.

Pinout

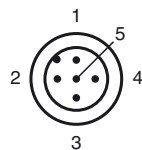

Wire colors in accordance with EN 60947-5-2

1	BN	(brown)
2	WH	(white)
3	BU	(blue)
4	BK	(black)
5	GY	(gray)

Accessories

- OMH-K01**
dove tail mounting clamp
- OMH-K02**
dove tail mounting clamp
- OMH-K03**
dove tail mounting clamp
- OMH-01**
Mounting aid for round steel \varnothing 12 mm or sheet 1.5 mm ... 3 mm
- OMH-06**
Mounting aid for round steel \varnothing 12 mm or sheet 1.5 mm ... 3 mm
- OMH-MLV12-HWG**
Mounting bracket for series MLV12 sensors
- OMH-MLV12-HWK**
Mounting bracket for series MLV12 sensors
- V15-G-2M-PVC**
Female cordset, M12, 5-pin, PVC cable

Function description

The sensor can be fully programmed by means of a push button and a selector switch on the top of the housing. A special feature of this sensor is the option of adapting the breadth of the ultrasonic beam to suit the ambient conditions at the point of use.

Normal operation

During normal operation the output stage of the sensor operates in accordance with the taught-in evaluation limits, the programmed mode of operation and characteristic of the sonic beam. In this made the selector switch must remain at the N position.

LED	Condition
Green LED	Continuous: Ready for operation
Yellow LED	Object detected within the evaluation limits

If the selector switch is not in the N position when the power supply is switched on, then this is indicated by simultaneous flashing of the green and yellow LEDs. However, the function of the output stage is as for the switch position N.

Teaching in of the evaluation range limits:

Within a time window of 5 minutes after switch-on of the power supply the sensor is ready for adaptation of the evaluation range limits to the requirements of the respective application.

- Place the object that is to be detected at one of the desired limits of the evaluation range.
- Set the selector switch to position A1.
- Now actuate the TEACH-IN button.

LED	before pressing button	on pressing button	after pressing button
Green	Off	Off	On
Yellow	Flashes: Positive detection of object	On	Evaluation limit displayed
Red	Flashes: No object detected On: Object not positively detected	Off	Off



- The teach-in procedure for the evaluation range limit can be repeated by repeatedly actuating the TEACH-IN button.
- Proceed in the same way for the second evaluation range limit, but set the selector switch to position A2.
- Return the selector switch to position N.

Note: Acceptance of the evaluation range limits into the permanent memory of the sensor does not take place until the selector switch is reset to N. If this acceptance does not take place within a time window of 5 minutes, the sensor continues to operate with unchanged values and the red and yellow LEDs flash.

The teach in sequence of the evaluation range limits (Near limit/Far limit) is arbitrary. Alternatively, the evaluation range limits can be set electrically, via the teach-in input. In this case the selector switch is left in the N position. The two evaluation limits are taught in by applying the potentials $+U_B$ (A1) and $-U_B$ (A2), respectively, for at least 500 ms to the teach-in input.

Parameter assignment of the output function

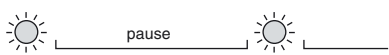
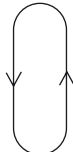
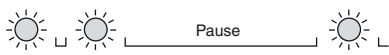
- Within a time window of 5 minutes from switching on the power supply the sensor is ready for adaptation of the output function.
- Set the selector switch to position M (Mode). The current set operating mode is indicated by the flashing sequence of the green LED.
 - The optional operating modes are selected by briefly actuating the TEACH-IN button (See flashing sequence of the green LED).

Operating mode	Flashing sequence of the green LED	T button
Rising ramp		
Falling ramp		
Zero point level		





Release date: 2016-04-25 09:25 Date of issue: 2019-01-25 202088_eng.xml

- Return the selector switch to position N when the desired operating mode is displayed.
Note: Acceptance of the operating mode into the permanent memory of the sensor does not take place until the selector switch is set to N. If this acceptance does not take place within a time window of 5 minutes, the sensor continues to operate with unchanged operating mode and the red and yellow LEDs flash.

Parameter assignment of the ultrasonic beam breadth

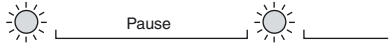
Within a time window of 5 minutes from switching on the power supply the sensor is ready for adaptation of the ultrasonic beam breadth.

- Set the selector switch to position B (Beam). The flashing sequence of the green LED indicates the currently set ultrasonic beam breadth.
- The optional beam breadths are selected by brief actuation of the TEACH-IN button (See flashing sequence of the green LED).

Characteristic	Flashing sequence of the green LED	T-Button
Narrow beam		
Medium beam		
Broad beam		

- Return the selector switch to position N when the desired beam breadth is indicated.
Note: Acceptance of the ultrasonic beam breadth into the permanent memory of the sensor does not take place until the selector switch is set to N. If this acceptance does not take place within the 5 minute time window, the sensor continues its operation with an unchanged ultrasonic beam breadth and the red and yellow LEDs flash.

Synchronisation

A synchronisation connection is provided for the suppression of mutual interference. If this is unused, or connected to 0V, then the sensor operates with an internally generated clock-pulse rate. The synchronisation of a number of sensors can be achieved by the following means.

External synchronisation:

The sensor can be synchronised by the external application of a square-wave voltage. A synchronisation pulse at the synchronisation input leads to the execution of a measuring cycle. The pulse width must be greater than 1.2 ms. The measuring cycle starts with the falling ramp. A low level > 1 s or an open synchronisation input leads to the normal operation of the sensor. A high level at the synchronisation input deactivates the sensor.

Two operating modes are possible.

- A number of sensors are triggered by the same synchronisation signal. The sensors operate in common mode.
- The synchronisation pulses are fed cyclically to one sensor at a time. The sensors operate in multiplex mode.

Self-synchronisation:

The synchronisation connections of up to 5 sensors are connected together to provide the option of self-synchronisation. When the operating voltage is switched on these sensors operate in multiplex mode. The switch-in delay increases depending on the number of sensors to be synchronised. Synchronisation cannot take place during teach-in and vice-versa. The sensors must be operated unsynchronised for the teaching-in of the switch points.

Note:

If the synchronisation option is not used, then the synchronisation input is connected to earth (0V) or the sensor is operated with a V1 connection cable (4-pole).

Release date: 2016-04-25 09:25 Date of issue: 2019-01-25 202088_eng.xml