

# P1PKxxx

Retro-Reflex Sensors for Clear Glass Recognition



## Operating Instructions

# Table of Contents

<b>1. General</b>	<b>3</b>
1.1 Information Concerning these Instructions	3
1.2 Explanations of Symbols	3
1.3 Limitation of Liability	4
1.4 Copyrights	4
<b>2. For Your Safety</b>	<b>5</b>
2.1 Use for Intended Purpose	5
2.2 Use for Other than the Intended Purpose	5
2.3 Personnel Qualifications	6
2.4 Modification of Products	6
2.5 General Safety Precautions	6
2.6 Approvals and protection class	6
<b>3. Technical Data</b>	<b>7</b>
3.1 Complementary Products	9
3.2 Layout	9
3.3 Control Panel	10
3.4 Scope of Delivery	10
<b>4. Transport and Storage</b>	<b>10</b>
4.1 Transport	10
4.2 Storage	10
<b>5. Installation and Electrical Connection</b>	<b>11</b>
5.1 Installation	11
5.2 Electrical Connection	11
5.3 Diagnostics	12
<b>6. Settings</b>	<b>14</b>
<b>7. I/O-Link</b>	<b>14</b>
<b>8. Maintenance Instructions</b>	<b>14</b>
<b>9. Proper Disposal</b>	<b>14</b>
<b>10. Appendix</b>	<b>15</b>
10.1 List of Abbreviations	15
10.2 Change Index, Operating Instructions	15
10.3 EU Declaration of Conformity	15

# 1. General

## 1.1 Information Concerning these Instructions

- These instructions apply to the product with ID code P1PKxxx.
- They make it possible to use the product safely and efficiently.
- These instructions are an integral part of the product and must be kept on hand for the entire duration of its service life.
- Local accident prevention regulations and national work safety regulations must be complied with as well.
- The product is subject to further technical development, and thus the information contained in these operating instructions may also be subject to change. The current version can be found at [www.wenglor.com](http://www.wenglor.com) in the product's separate download area.



### NOTE!

The operating instructions must be read carefully before using the product and must be kept on hand for later reference.

## 1.2 Explanations of Symbols

- Safety precautions and warnings are emphasized by means of symbols and attention-getting words
- Safe use of the product is only possible if these safety precautions and warnings are adhered to

The safety precautions and warnings are laid out in accordance with the following principle:



---

### Attention-Getting Word! Type and Source of Danger!

Possible consequences in the event that the hazard is disregarded.

- Measures for averting the hazard.

---

The meanings of the attention-getting words, as well as the scope of the associated hazards, are listed below.



---

### DANGER!

This word indicates a hazard with a high degree of risk which, if not avoided, results in death or severe injury.

---



---

### WARNING!

This word indicates a hazard with a medium degree of risk which, if not avoided, may result in death or severe injury.

---



---

### CAUTION!

This word indicates a hazard with a low degree of risk which, if not avoided, may result in minor or moderate injury.

---



---

### ATTENTION!

This word draws attention to a potentially hazardous situation which, if not avoided, may result in property damage.

---



---

### NOTE!

A note draws attention to useful tips and suggestions, as well as information regarding efficient, error-free use.

---

### 1.3 Limitation of Liability

- The product has been developed in consideration of the current state-of-the-art and applicable standards and guidelines. Subject to change without notice.
- A valid declaration of conformity can be accessed at [www.wenglor.com](http://www.wenglor.com) in the product's separate download area.
- wenglor sensoric elektronische Geräte GmbH (hereinafter referred to as "wenglor") excludes all liability in the event of:
  - Non-compliance with the instructions
  - Use of the product for purposes other than those intended
  - Use by untrained personnel
  - Use of unapproved replacement parts
  - Unapproved modification of products
- These operating instructions do not include any guarantees from wenglor with regard to the described procedures or specific product characteristics.
- wenglor assumes no liability for printing errors or other inaccuracies contained in these operating instructions, unless wenglor was verifiably aware of such errors at the point in time at which the operating instructions were prepared.

### 1.4 Copyrights

- The contents of these instructions are protected by copyright law.
- All rights are reserved by wenglor.
- Commercial reproduction or any other commercial use of the provided content and information, in particular graphics and images, is not permitted without previous written consent from wenglor.

## 2. For Your Safety

### 2.1 Use for Intended Purpose

The product is based on the following functional principle:

#### Retro-Reflex Sensors for Clear Glass Recognition

Reflex sensors for clear glass recognition can be adjusted so precisely that they can reliably recognize highly transparent objects such as glass, glass bottles or sheet products. Even shiny, chromed or reflective surfaces can be reliably detected thanks to the integrated polarization filter.

The transmitter and receiver are located in a single housing and require a reflector to work. The output switches if the light beam between the sensor and reflector is interrupted. The visible light spot of retro-reflex sensors facilitates adjustment and commissioning. Depending on the sensor type, even small objects up to 0.1mm can be reliably detected over long distances.

#### This product can be used in the following industry sectors:

- Special machinery manufacturing
- Heavy machinery manufacturing
- Logistics
- Automotive industry
- Food industry
- Packaging industry
- Pharmaceuticals industry
- Plastics industry
- Woodworking industry
- Beverages industry
- Consumer goods industry
- Paper industry
- Electronics industry
- Glass industry
- Steel industry
- Aviation industry
- Chemicals industry
- Alternative energy
- Raw materials extraction

### 2.2 Use for Other than the Intended Purpose

- Not a safety component in accordance with 2006/42/EC (Machinery Directive)
- The product is not suitable for use in potentially explosive atmospheres.
- The product may only be used with accessories supplied or approved by wenglor, or combined with approved products. A list of approved accessories and combination products can be accessed at [www.wenglor.com](http://www.wenglor.com) on the product detail page.

---

#### **DANGER!**



#### **Risk of personal injury or property damage in case of use for other than the intended purpose!**

- Use for other than the intended purpose may lead to hazardous situations.
- Observe instructions regarding use for intended purpose.
-

## 2.3 Personnel Qualifications

- Suitable technical training is a prerequisite.
- In-house electronics training is required.
- Trained personnel must have uninterrupted access to the operating instructions.



### **DANGER!**

**Risk of personal injury or property damage in case of incorrect initial start-up and maintenance!**

- Personal injury and damage to equipment may occur.
- Adequate training and qualification of personnel.

## 2.4 Modification of Products



### **DANGER!**

**Risk of personal injury or property damage if the product is modified!**

- Personal injury and damage to equipment may occur. Non-observance may result in loss of the CE marking and the guarantee may be rendered null and void.
- Modification of the product is impermissible.

## 2.5 General Safety Precautions



### **NOTE!**

- These instructions are an integral part of the product and must be kept on hand for the entire duration of its service life.
- In the event of possible changes, the respectively current version of the operating instructions can be accessed at [www.wenglor.com](http://www.wenglor.com) in the product's download area.
- Read the operating instructions carefully before using the product.
- Protect the sensor against contamination and mechanical influences.

## 2.6 Approvals and protection class



### 3. Technical Data

Technical Data	Order Number	P1PK	
		101	103
<b>Optical Data</b>			
Range		2,600 mm	
Reference reflector		RQ100BA	
Clear glass recognition		yes	
Switching hysteresis		< 5 %	
Light source		Red light	
Polarization filter		yes	
Service life (ambient temp. = +25° C)		100,000 h	
Max. permissible ambient light		10,000 Lux	
Single-lens optics		yes	
Spot diameter		See table 1	
Smallest detectable part		See table 2	
<b>Electrical Data</b>			
Supply power		10...30 V DC	
IO-Link supply voltage		18...30 V DC	
Current consumption (operating voltage = 24 V)		< 20 mA	
Switching frequency		2000 Hz	
Switching frequency (speed mode)		3500 Hz	
Response time		0,25 ms	
Response time (speed mode)		0,14 ms	
Temperature drift		< 5 %	
Temperature range		-40...60 °C	
Switching output voltage drop		< 2 V	
Switching output switching current		100 mA	
Switching output residual current		< 50 µA	
Short-circuit protection		yes	
Reverse polarity protected		yes	
Overload-proof		yes	
Lockable		yes	
Interface		IO-Link	
IO-Link version		1.1	
Protection class		III	
Output function	PNP antivalent	×	
	NPN antivalent		×
Connection Diagram No.		215	213
<b>Mechanical Data</b>			
Setting method		Potentiometer	
Housing material		Plastic	
Degree of protection		IP67/IP68	
Connection		Plug M12; 4-pin	
Lens cover		PMMA	
<b>Technical Safety Data</b>			
MTTFd (EN ISO 13849-1)		2414 a	

### 3.6.1 Spot diameter

Working Distance	0,5 m	1,3 m	2,6 m
Spot diameter	30 mm	45 mm	80 mm

Table 1

### 3.6.2 Smallest detectable part

Distance, Sensor to Reflector	0,5 m	1,3 m	2,6 m
Smallest detectable part	1,5 mm	4 mm	15 mm

Table 2

### 3.6.3 Switching distance

Achievable switching distance depends on the utilized reflector. Nominal switching distance is achieved with reflector types RQ100BA. Achievable ranges for other reflectors are listed in the following tables:

Reflector	Range
RQ100BA	0...2,60 m
RE18040BA	0...1,50 m
RQ84BA	0...1,80 m
RR84BA	0...2,20 m
RE9538BA	0...0,85 m
RE6151BH	0...0,90 m
RE6151BM	0...2,00 m
RR50_A	0...1,55 m
RE6040BA	0...1,80 m
RE8222BA	0...1,10 m
RR34_M	0...1,20 m
RE3220BM	0...0,90 m
RE6210BM	0...0,50 m
RR25_M	0...0,65 m
RR25KP	0...0,35 m
RR21_M	0...0,65 m
ZRME01B01	0...0,25 m
ZRME03B01	0...1,10 m
ZRAE02B01	0...0,90 m
ZRMR02K01	0...0,30 m
ZRMS02_01	0...0,50 m
ZRAF08K01	0...0,40 m
ZRAF07K01	0...0,40 m
ZRDF03K01	0...1,30 m
ZRDF10K01	0...1,40 m
RF505	0...0,40 m
RF255	0...0,40 m
RF508	0...0,40 m
RF258	0...0,40 m
RF4050	0...0,30 m





**NOTE!**

- In order to increase the stability in the detection of highly transparent objects, it is recommended to use reflectors with microstructure.

### 3.1 Complementary Products

wenglor can provide you with suitable connection technology for your product.

Suitable mounting technology no. **380**

Suitable connection technology no. **2**

**S02**

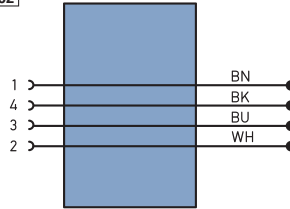

IO-Link master

wTeach2 software DNNF005

### 3.2 Layout

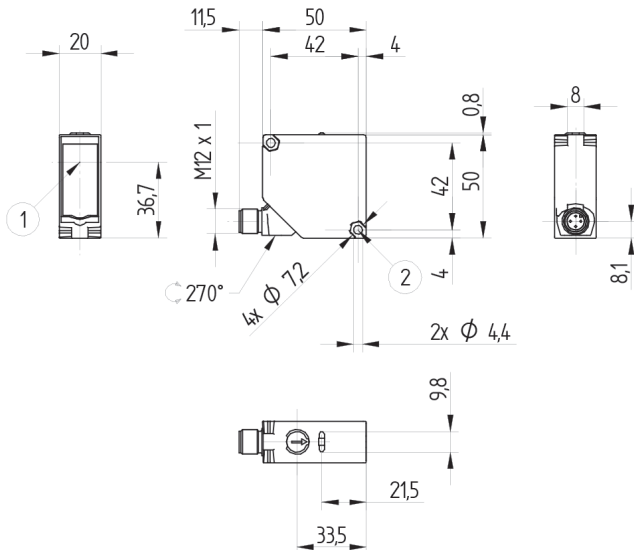

1 = Optical axis  
M4 screw = 0.5 Nm  
Potentiometer = 40 Nmm  
Dimensions specified in mm  
(1 mm = 0.03937")

### 3.3 Control Panel

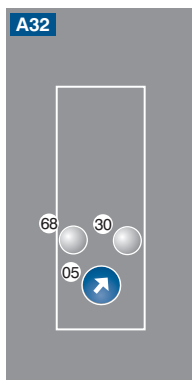

05 = switching distance adjuster  
30 = switching status indicator / contamination warning  
68 = supply power indicator

### 3.4 Scope of Delivery

- Sensor
- Safety precautions
- Mounting-Set 14
- Spacer sleeves Z1PE002

## 4. Transport and Storage

### 4.1 Transport

Upon receipt of shipment, the goods must be inspected for damage in transit. In the case of damage, conditionally accept the package and notify the manufacturer of the damage. Then return the device, making reference to damage in transit.

### 4.2 Storage

**The following points must be taken into condition with regard to storage:**

- Do not store the product outdoors.
- Store the product in a dry, dust-free place.
- Protect the product against mechanical impacts.
- Protect the product against exposure to direct sunlight.

---

#### **ATTENTION!**



#### **Risk of property damage in case of improper storage!**

The product may be damaged.

- Storage instructions must be complied with.
-

## 5. Installation and Electrical Connection

### 5.1 Installation

- Protect the product from contamination during installation.
- Observe all applicable electrical and mechanical regulations, standards, and safety rules.
- Protect the product against mechanical influences.
- Make sure that the sensor is mounted in a mechanically secure fashion.
- Specified torque values must be complied with (see section “3.2 Layout”, page 9).

#### ATTENTION!



#### Risk of property damage in case of improper installation!

The product may be damaged.

- Installation instructions must be complied with.

#### CAUTION!



#### Risk of personal injury or property damage during installation!

Personal injury and damage to the product may occur.

- A safe installation environment must be assured.

### 5.2 Electrical Connection

[213]

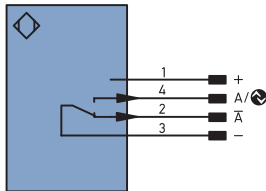

[215]

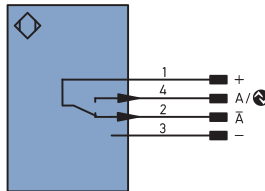

#### Legend

+	Supply Voltage +
-	Supply Voltage 0 V
~	Supply Voltage (AC Voltage)
A	Switching Output (NO)
A̅	Switching Output (NC)
V	Contamination/Error Output (NO)
V̅	Contamination/Error Output (NC)
E	Input (analog or digital)
T	Teach Input
Z	Time Delay (activation)
S	Shielding
RxD	Interface Receive Path
TxD	Interface Send Path
RDY	Ready
GND	Ground
CL	Clock
E/A	Output/Input programmable
	IO-Link
PaE	Power over Ethernet
IN	Safety Input
OSD	Safety Output
Signal	Signal Output
BI_D-/-	Ethernet Gigabit bidirect. data line (A-D)
EN <sup>RES42</sup>	Encoder 0-pulse 0-0 (TTL)

PT	Platinum measuring resistor
nc	not connected
U	Test Input
Ū	Test Input inverted
W	Trigger Input
O	Analog Output
O-	Ground for the Analog Output
BZ	Block Discharge
Aw/	Valve Output
a	Valve Control Output +
b	Valve Control Output 0 V
SY	Synchronization
E+	Receiver-Line
S+	Emitter-Line
⊖	Grounding
SnR	Switching Distance Reduction
Rx+/-	Ethernet Receive Path
Tx+/-	Ethernet Send Path
B <sub>aa</sub>	Interfaces-Bus A(+)/B(-)
La	Emitted Light disengageable
Mag	Magnet activation
RES	Input confirmation
EDM	Contactor Monitoring
EN <sup>RES42</sup>	Encoder A/A (TTL)
EN <sup>RES42</sup>	Encoder B/B (TTL)

ENA	Encoder A
ENB	Encoder B
AMIN	Digital output MIN
AMAX	Digital output MAX
AOk	Digital output OK
SY In	Synchronization In
SY OUT	Synchronization OUT
GLT	Brightness output
M	Maintenance
RSV	reserved

#### Wire Colors according to DIN IEC 757

BK	Black
BN	Brown
RD	Red
OG	Orange
YE	Yellow
GN	Green
BU	Blue
VT	Violet
GY	Grey
WH	White
PK	Pink
GNYE	Green/Yellow



## DANGER!

### Risk of personal injury or property damage due to electric current!

Voltage conducting parts may cause personal injury or damage to equipment.

- The electric device may only be connected by appropriately qualified personnel.

## 5.3 Diagnostics

Causes for Triggering the Contamination Warning (blinking LED):

Display LED	Diagnosis/Cause	Elimination
Continuous blinking at approx. 2.5 Hz	Contamination	Carefully clean the optic cover with a cloth.
	Aged emitter diode	Replace the sensor.
	Unreliable working range	<ul style="list-style-type: none"><li>• Increase the sensor's switching distance.</li><li>• Reduce distance between sensor and reflector.</li></ul>
Continuous blinking at approx. 5 Hz	Short-circuit	Check electrical wiring and eliminate the short-circuit.
	Over-temperature	Disconnect the sensor from supply power and allow it to cool down.
	Hardware error	Replace the sensor.

## Contamination Warning Flowcharts

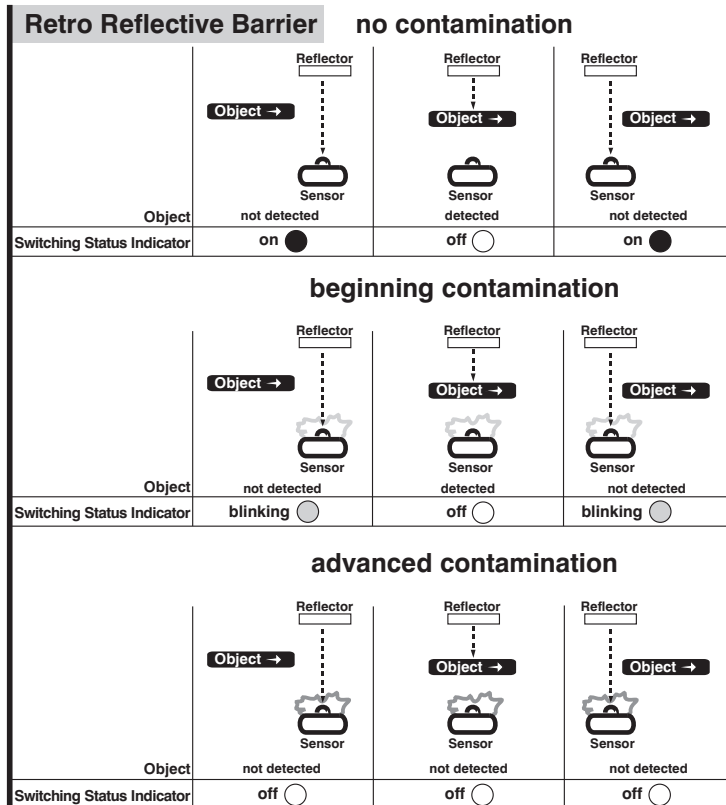

### Required action in case of fault:

#### NOTE!

- Shut down the machine.
- Analyze and eliminate the cause of error with the help of the diagnostics information.
- If the error cannot be eliminated, please contact wenglor's support department.
- Do not operate in case of indeterminate malfunctioning.
- The machine must be shut down if the error cannot be unequivocally clarified or reliably eliminated.



#### DANGER!

#### Risk of personal injury or property damage in case of non-compliance!

- The system's safety function is disabled. Personal injury and damage to equipment.
- Required action as specified in case of fault.



## 6. Settings

- Align the sensor to the reflector.
- Make sure that the sensor and the reflector are mounted in a mechanically secure fashion.
- Turn the potentiometer all the way to the left.
- Turn the potentiometer clockwise until the output is switched.
- Continue to turn up the potentiometer until the LED no longer blinks.
- Move the object into the light barrier and check for correct functioning.

## 7. I/O-Link

Further settings are possible via the IO-Link interface. The IO-Link can be found at [www.wenglor.com](http://www.wenglor.com) in the product's download area.

## 8. Maintenance Instructions

### NOTE!



- This wenglor sensor is maintenance-free.
- Cleaning and inspection of the plug connections at regular intervals are advisable.
- Do not clean the sensor with solvents or cleansers which could damage the product.
- The product must be protected against contamination during initial start-up.

## 9. Proper Disposal

wenglor sensoric GmbH does not accept the return of unusable or irreparable products. Respectively valid national waste disposal regulations apply to product disposal.

## 10. Appendix

### 10.1 List of Abbreviations

Abbreviation	Meaning
Tu	Ambient temperature
Ub	Supply voltage
IODD	IO Device Description
MTTFd	Mean Time to Dangerous Failure

### 10.2 Change Index, Operating Instructions

Version	Date	Description/Change
1.0.0	06.12.18	Initial version of the operating instructions

### 10.3 EU Declaration of Conformity

The EU declaration of conformity can be found on our website at [www.wenglor.com](http://www.wenglor.com) in the product's download area.