

EN

OSEBxxxZ0103

OEEBxxxU0135

High-performance distance sensor



Operating Instructions

Table of contents

1. Proper Use	4
2. Safety Precautions	4
3. EC Declaration of Conformity	4
4. Technical Data	5
4.1. Data sheet	5
4.2. Connection Diagrams	6
4.3. Housing Dimensions	6
4.4. Control Panel	7
4.5. Complementary Products (see catalog)	7
5. Mounting instructions	7
5.1. Mounting	7
5.1.1 Mounting at profiles	8
5.1.2 Mounting on flat surfaces	8
5.2. Alignment	9
6. Initial Operation	10
6.1. Setup	10
6.2. Overview of functions	11
6.3. Menu Structure	12
6.4. Beam Arrangement	13
6.5. Communication Beam	13
6.6. Suppression of Reciprocal Influence Amongst Individual Beams	13
6.7. Test Input Function	13
6.8. Error Output Function	14
6.9. Tolerance	14
7. Settings	15
7.1. Run	15
7.2. Pin Function	15
7.3. A1 Switch	16
7.3.1 Teach Beams	16
7.3.2 Teach-In Pattern	16
7.3.3 Two-Step Teach-In	17
7.3.4 Teach-In Range	18

7.4. E/A2	21
7.4.1 E Teach	21
7.4.2 E Setup	21
7.4.3 A2 Switch	21
7.4.4 A2 Error	21
7.5. Analog	22
7.5.1 Position	22
7.5.2 Web Edge	23
7.6. Blanking	26
7.7. E/A Test	27
7.8. Expert Menu	27
7.9. Display Definition	28
7.10. Language	29
7.11. Information	29
7.12. Reset	29
7.13. Password	30
7.14. Start Setup	31
8. IO-Link Parameter and Process data	31
9. Maintenance Instructions	38
10. Proper Disposal	38

1. Proper Use

This wenglor product is used in accordance with the following mode of operation:

Light Curtain for Measuring Tasks

Light grids for measuring tasks function in accordance with the barrier principle. This means that transmitter and receiver are housed separately. These housings are installed in such a way that the beam of light from the transmitter hits the optical receiver. Switching output depends on which and how many beams are interrupted. An analog output provides that information in the form of relevant voltage or power. The transmitters are equipped with a test input for function tests.

2. Safety Precautions

- This operating instruction is part of the product and must be kept during its entire service life.
- Read this operating instruction carefully before using the product.
- Installation, start-up and maintenance of this product has only to be carried out by trained personal.
- Tampering with or modifying the product is not permissible.
- Protect the product against contamination during start-up.
- Not a safety component in accordance with the EU Machinery Directive.

3. EC Declaration of Conformity

The EC declaration of conformity can be found on our website at www.wenglor.com in download area



RoHS

4. Technical Data

4.1. Data sheet

Range	3000 mm
Opening Angle	10°
Beam Distance	30 mm
Supply Voltage	18...30 V DC
Current Consumption (U _b = 24 V)	< 40 mA
Temperature Drift	< 10 %
Temperature Range	-25...60 °C
Housing	Aluminium
Reverse Polarity Protection	yes
Full Encapsulation	yes
Degree of Protection	IP65
Connection	M12×1
Protection Class	III
Emitter	
Light Source	Infrared Light
Wave Length	880 nm
Service Life (T = 25 °C)	100000 h
Receiver	
max. Ambient Light	10000 Lux
ON-/OFF-Delay	0...10000 ms
Switching Output Voltage Drop	< 2,5 V
Switching Outputs	2
Switching Output/Switching Current	100 mA
Residual Current Switching Output	< 50 mA
Analog Output	0...10 V
Analog Output	4...20 mA
Short Circuit Protection	yes
Overload Protection	yes
IO-Link Version	1.0
Password Protection	yes
Menu language	yes
Output Function	Configurable as PNP or push-pull NC/NO, switchable IO-Link Analog Output

Order No.	OSEB152Z0103 OEEB152U0135	OSEB302Z0103 OEEB302U0135	OSEB452Z0103 OEEB452U0135	OSEB602Z0103 OEEB602U0135	OSEB752Z0103 OEEB752U0135	OSEB902Z0103 OEEB902U0135	OSEB103Z0103 OEEB103U0135	OSEB123Z0103 OEEB123U0135	OSEB133Z0103 OEEB133U0135	OSEB153Z0103 OEEB153U0135	OSEB163Z0103 OEEB163U0135	OSEB183Z0103 OEEB183U0135
Measurement Field Height	150 mm	300 mm	450 mm	600 mm	750 mm	900 mm	1050 mm	1200 mm	1350 mm	1500 mm	1650 mm	1800 mm
Switching Frequency	69 Hz	41 Hz	29 Hz	22 Hz	18 Hz	16 Hz	13 Hz	12 Hz	11 Hz	10 Hz	9 Hz	8 Hz
Response Time	7 ms	12 ms	17 ms	22 ms	27 ms	32 ms	37 ms	42 ms	47 ms	52 ms	57 ms	62 ms

4.4. Control Panel

Emitter

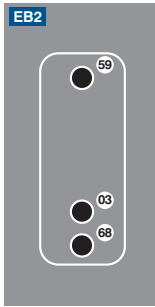

59 = Calibration
 03 = Error Indicator
 68 = Supply Voltage Indicator

Receiver

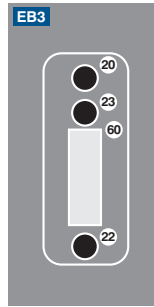

22 = Up Button
 60 = Display
 23 = Down Button
 20 = Enter Button

4.5. Complementary Products (see catalog)

wenglor offers Connection Technology providing field wiring means.

Suitable Connection Technology No.

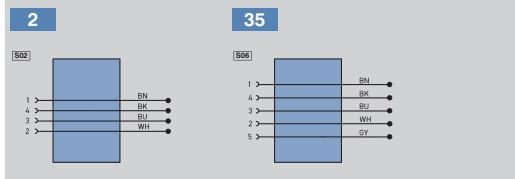

IO-Link Master

5. Mounting instructions

During operation of the Sensors, the corresponding electrical and mechanical regulations, as well as safety regulations must be observed. The Sensor must be protected from mechanical impact. Install the device such that its installation position cannot be inadvertently changed.

5.1. Mounting

The mounting of the Light Curtains is made over the through-holes in the profiles. The hole distance can be taken from the drawing.

5.1.1 Mounting at profiles

In case of mounting at profiles M4 screws have to be used. These are put through the holes in the Light Curtain and are tightened with respective M4 slot nuts in the profile.

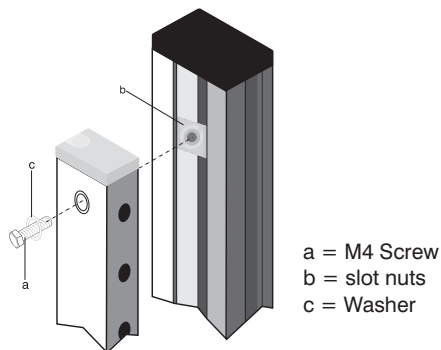

5.1.2 Mounting on flat surfaces

In case of mounting at flat surfaces M5 screws have to be used. These are put through the mounting surface and are tightened over the thread inside the through-hole of the Light Curtain.

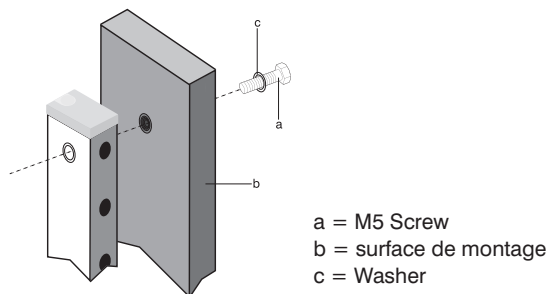

5.2. Alignment

In order to assure flawless functioning of the Light Barrier, the two matched components (emitter and receiver) must be aligned to one another, and mounted parallel at the same height. The electrical plug connectors of both components point in the same direction. It is advisable to mount the Light Barrier for initial start-up such that alignment can still be adjusted to an adequate extent.

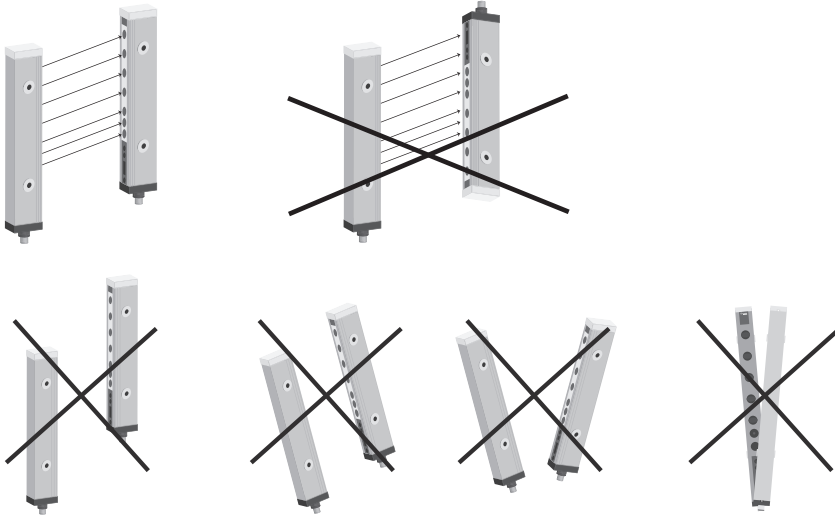

Correct alignment is indicated by the bar graph at the display. When all beams are shown as uninterrupted, the Light Barrier is correctly aligned.

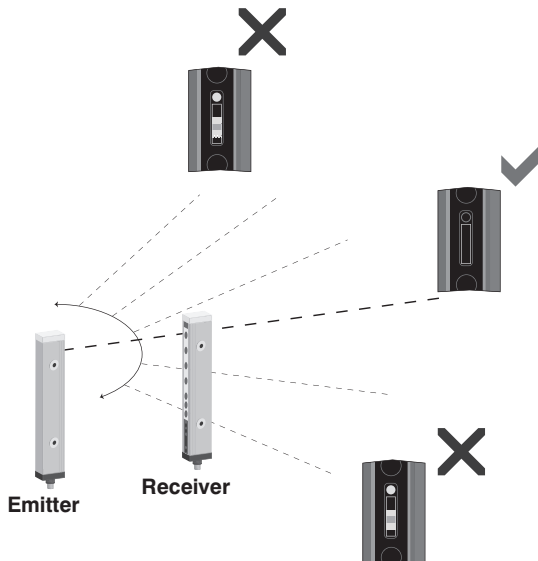

6. Initial Operation

- Electrically connect the emitter and the receiver in accordance with the wiring diagrams.
- The desired menu language must be selected at initial start-up, and after each reset (see section 7.10).

Switch to the configuration menu by pressing any key.

Note: If no settings are adjusted in the configuration menu for a period of 30 seconds, the sensor is automatically returned to the display mode.

The sensor accesses the last used menu view when a key is once again activated. If a setting is configured, it becomes active when the configuration menu is exited.

The keys are used for navigation, and for configuring settings. The functions of the navigation keys vary from menu to menu. The functions of the keys appear in the display as follows:

- ▲ : Navigate up.
- ▼ : Navigate down.
- ◀ Back: Move up one level within the menu.
- ⏪ Run: Switch to the display mode.

Selection is acknowledged with the enter key.

Important: Do not use any sharp objects to press the keys when configuring settings, because they might otherwise be damaged.

6.1. Setup

After putting the Light Curtain into service it has to be setup in order to configurate the sensitivity.

Note: During the whole setup process no beam should be covered.

- Select the point “Setup” in the menu and start the process by pressing the Enter key.
- The orange LED for setup shines until the setup is done (approx. 5 sec.). The process is also shown at the display.
- If the setup is successful the setup LED will disappear and in the bar diagram of the display all beams are shown as not interrupted. You can then proceed with the other settings.
- If the orange setup LED remains, the following points have to be checked and the process has to be repeated:
 - Check if objects are located inside the measuring field and the beams are uncovered. If so, remove the object or contamination
 - Check the alignment of transmitter and receiver – transmitter and receiver have to be mounted at the same height exactly parallel to each other.
- If the red error LED shines, an internal error occurred during the setup and the process has to be repeated.

6.2. Overview of functions

Description	Function	Page
Run	Switch to display mode	15
Pin Function	Configure function for A1	15
A1 Switch	Configure the output function of A1	16
E/A2	Configure the input-/output functions of E/A2	15
Analog	Configure function of the analog output	27
Blanking	Blanking Beams	27
E/A-Test	Testing input-/output	27
Expert Menu	Activating/Deactivating the Expert Menu	27
Display	Select display characteristics	28
Language	Select the desired menu language	29
Info	Read out information regarding the sensor	29
Reset	Return to default settings	29
Password	Protection against unauthorized changes to settings	30
Start Setup	Start setup procedure	31

6.3. Menu Structure

The Sensor's menu is laid out as follows:

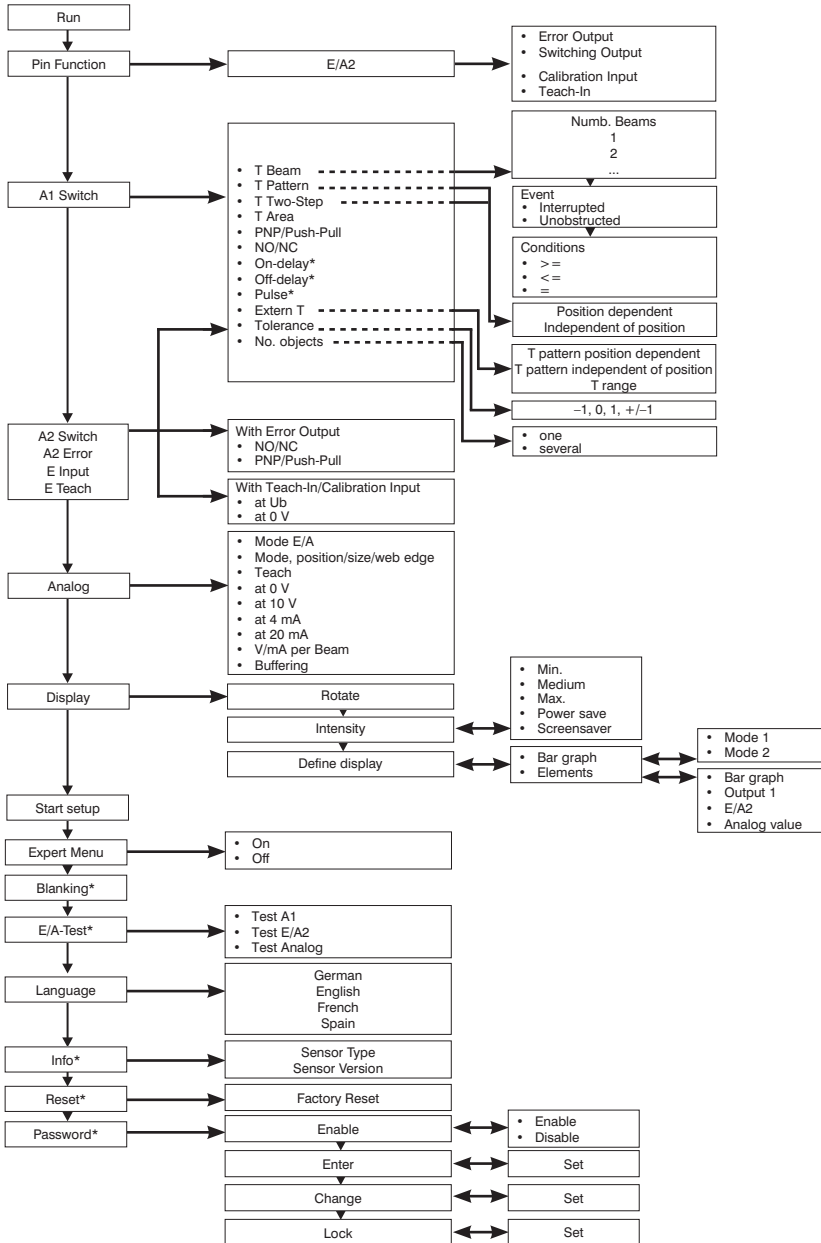

* Only visible if expert menu is set to "on".

6.4. Beam Arrangement

The Light Barrier's beams are numbered consecutively (beam 1 is the beam which is closest to the display). The beam numbers included in the following descriptions are consecutive numbers.

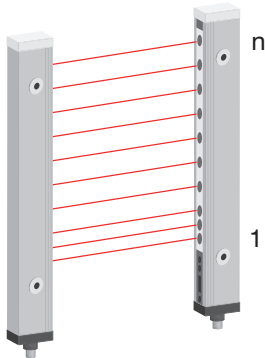

6.5. Communication Beam

The communication beam is located between the first and second beams. The emitter communicates with the receiver via this beam in order to adjust the intensity of the individual beams during setup. This beam has a communication function only and is not used for evaluation purposes, for which reason it is not numbered. This beam has no function during actual operation, and can thus be interrupted without consequence.

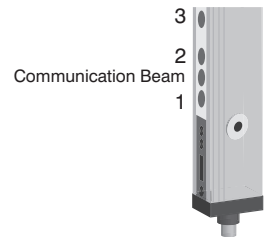

6.6. Suppression of Reciprocal Influence Amongst Individual Beams

Thanks to an innovative new process, the emitter does not have to be synchronized to the receiver. Accordingly, there is no synchronization via a synchronizing cable or specific synchronizing beams.

With this Light Barrier, each emitter-receiver pair is optically coded. As a result, the individual beams do not influence each other and no synchronization is necessary.

6.7. Test Input Function

If the test input is open or connected to negative potential, the Sensor functions normally. If positive potential is applied for roughly 3 seconds and then disconnected, the transmitter shuts down all of the beams, one after the other. The Light Curtain is tested by means of the resultant change in switching status at the receiver.

6.8. Error Output Function

Light Curtain for measuring tasks in EB variant:

The error output is activated as soon as a beam is interrupted during testing via the test input (see section 6.7). This can be caused due to an object located within the measuring field at the point in time that testing takes place, or by a non-functioning beam. The error output remains activated for approximately 1 second.

6.9. Tolerance

During the course of dynamic processes, situations arise which cause a certain object to interrupt varying numbers of beams due to its variable position within the measuring field.

In order to assure that taught in objects are reliably detected despite this situation, a tolerance can be assigned to them.

Example:

- The object in figure 1 has been taught in. It moves down within the measuring field. As shown in figure 2, the object would not be detected without the help of the tolerance function, because a different number of beams were interrupted during Teach-In.
- If a tolerance of plus one beam is selected, the object can be up to one beam larger than it was during Teach-In, in order to assure that it is nevertheless detected.

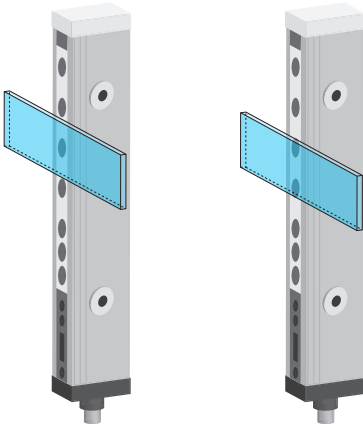

Three different tolerance types can be selected:

- 1: The object may be one beam smaller than the taught in object and is still recognized.
- +1: The object may be one beam larger than the taught in object and is still recognized.
- ±1: The object may be one beam larger or smaller than the taught in object and is still recognized.



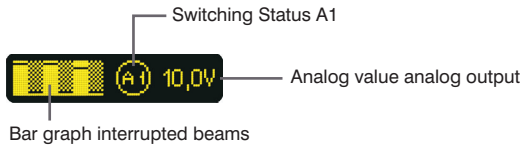

7. Settings

7.1. Run

The sensor is switched to the display mode when the enter key is pressed.



The function selected for this pin appears as a symbol in the display mode:

-  Teach-In for A1
-   Switching Output
-  Setup input
-  Switching Output

7.2. Pin Function

The pin function is used to specify the function assigned to pin E/A2. Various functions can be assigned to this pin.

Note: If a class B IO-Link master is used (at pin 5, GND), the pin function must be set to input (Teach-In input or setup input).

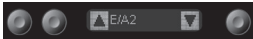
Function	Description
E/A2	Configuration of Pin E/A2
	<p>Pin E/A2 can be configured by pressing the ▲ and ▼ keys</p> <ul style="list-style-type: none"> • Switching Output • Error Output • Setup input • Teach-In for A1

7.3. A1 Switch

Switching output 1 is set up here.

Four different modes are available, making it possible to adapt the Light Barrier's switching output to the respective application by means of predefined functions.

7.3.1 Teach Beams

The number of interrupted or uninterrupted beams which cause the output to switch, as well as the condition under which it switches, are selected via the menu. Only the number of beams is evaluated – the position and arrangement of the beams is not taken into consideration.

Example:

The output should be switched when exactly two beams are interrupted:

Number of beams: 2

Result: Interrupted

Condition: =

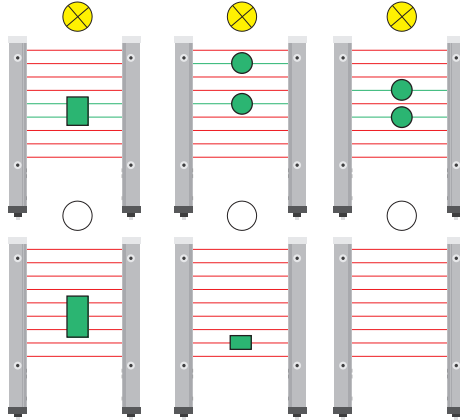

7.3.2 Teach-In Pattern

An object with a given beam pattern is taught in. The switching output is switched as soon as the taught in pattern is recognized. Differentiation is made between patterns which are position dependent and independent of position.

Teach-In pattern, position dependent: In order to be recognized and cause the output to be switched, the pattern to be detected must be at exactly the same position within the measuring fields as it was during Teach-In.

Example:

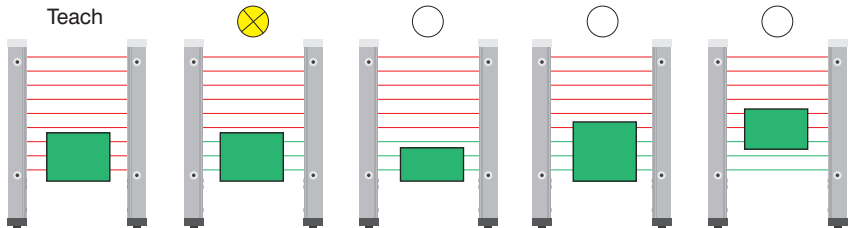

Example:

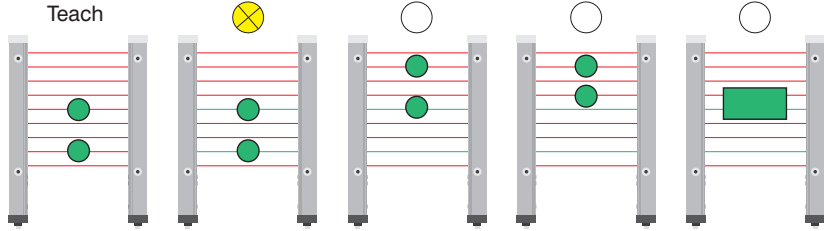

Teach-In pattern, independent of position: The taught in pattern can be located anywhere within the measuring field and is always recognized, thus causing the output to be switched.

Example:

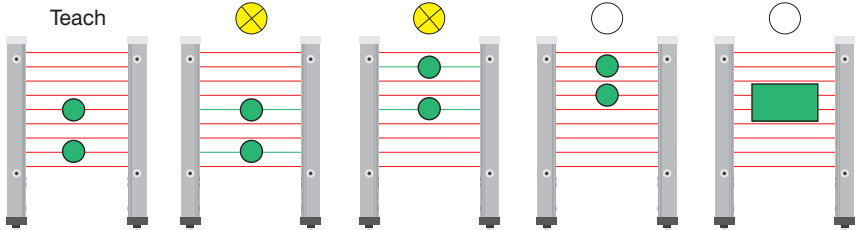

7.3.3 Two-Step Teach-In

Two objects are taught in, one after the other. The switching output is switched as soon as objects are detected within the measuring field whose size is between the sizes of the two taught in objects.

Two-step Teach-In, position dependent: The objects to be detected are always at the same position within the measuring field. The height of the uppermost interrupted beam is evaluated.

Example:

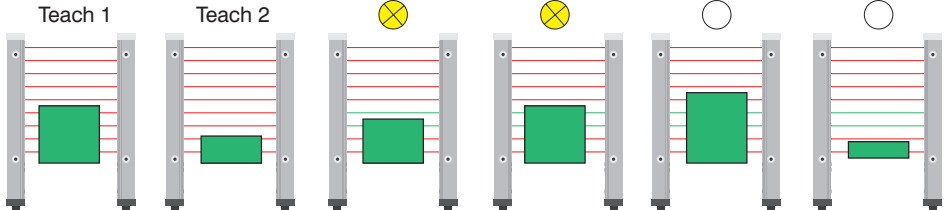

Two-step Teach-In, independent of position: The taught in objects can be located anywhere within the measuring field and are always recognized, thus causing the output to be switched. The size of the objects is evaluated.

Example:

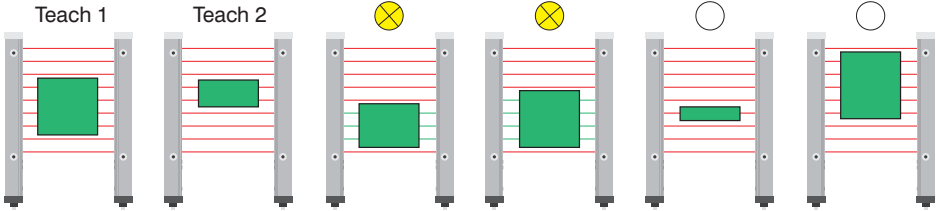

Example:

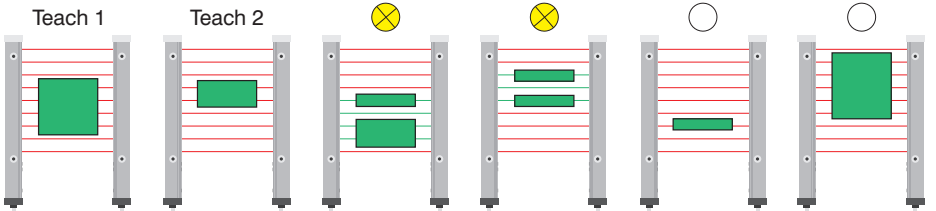

7.3.4 Teach-In Range





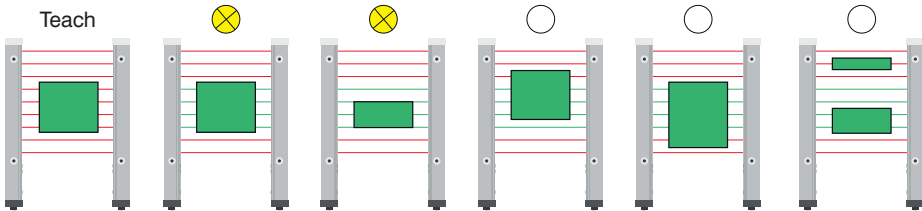



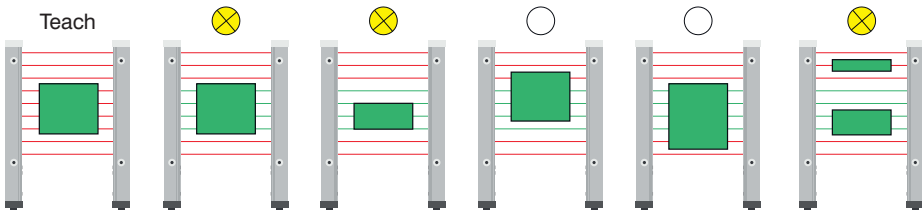

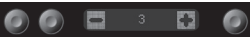
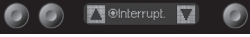
A range is taught in. The switching output is switched as soon as an object is detected within the taught in range, regardless of its size.

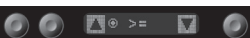
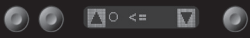

Example 1: Setting "No. objects" on "one".

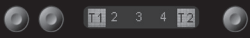

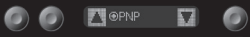
Example 2: Setting "No. objects" on "several".

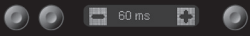
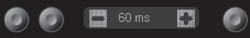

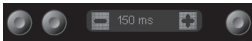
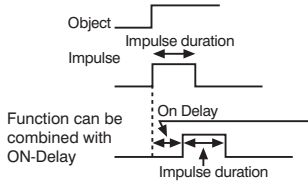
Function	Description
T Beams	
	Number of beams: The number of unobstructed or interrupted beams is set with the + or – key.
	Event: The navigation keys are used to select whether interrupted or unobstructed beams will be used for evaluation. This entry is acknowledged with the enter key.
	
	Condition: The navigation keys are used to specify under which condition the output will be switched. This entry is acknowledged with the enter key.
	>=: In the event that the same or a larger number of beams is interrupted/unobstructed, the output is switched.
	<=: In the event that the same or a smaller number of beams is interrupted/unobstructed, the output is switched.
	=: The input is switched when exactly the specified number of beams is interrupted/unobstructed.
T Range	
	First of all, the ▼ and ▲ keys are used to select whether detection should be position dependent or independent of position. This entry is acknowledged with the enter key. The object to be taught in is positioned within the measuring field. The pattern is then taught in by pressing the T key.
T Two-step	
	First of all, the ▼ and ▲ keys are used to select whether detection should be position dependent or independent of position. This entry is acknowledged with the enter key. The first object to be taught in is positioned within the measuring field. The first object is then taught in by pressing the T1 key. The first object is subsequently removed and the second object is then positioned within the measuring field and taught in by pressing the T2 key.
T Area	
	The range to be taught in is obstructed within the measuring field. The range is then taught in by pressing the T key.
PNP/Push-Pull	Selecting the Output Type
	The PNP, NPN or push-pull output type can be selected by pressing the ▼ and ▲ keys, and selection is acknowledged by pressing the enter key.
	
NO/NC	Selecting the Output Type
	The normally open or normally closed output function is selected by pressing the NO or the NC key. The respective circuit diagram is displayed.
On-Delay	Adjusting On-Delay
	On-delay can be adjusted within a range of 0 to 10000 ms by pressing the + or – key.*
Off-Delay	Adjusting Off-Delay
	Off-delay can be adjusted within a range of 0 to 10000 ms by pressing the + or – key.* Off-delay is disabled if a impulse duration has already been selected.

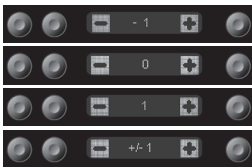
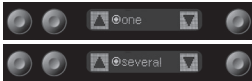
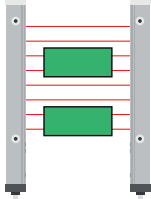
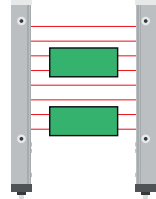
Function	Description
Impulse 	<p>Adjusting Impulse Duration</p> <p>Pulse duration defines how long the output signal remains in the activated state. An impulse length can be selected within a range of 0 to 10000 ms by pressing the + or - key.* After the selected pulse duration has elapsed, the output signal is returned to the deactivated state.</p> 
External T 	<p>External Teach-In</p> <p>Selection as to whether a “position dependent T pattern”, a “T pattern independent of position” or a “T range” range is executed can be selected during external Teach-In with the ▲ and ▼ keys.</p>
Tolerance 	<p>Beam Tolerance</p> <p>After pressing the + or - key, selection can be made as to whether or not a tolerance will be activated for the utilized Teach-In mode (see section 6.3).</p> <ul style="list-style-type: none"> -1: One beam less than taught in may be interrupted, and the object is still detected. 0: The tolerance function is deactivated. +1: One beam more than taught in may be interrupted, and the object is still detected. +/-1: One beam more and/or less than taught in may be interrupted, and the object is still detected.
No. objects 	<p>Number of objects inside the measuring field</p> <p>Press keys ▲ and ▼ to choose whether “one” or “several” objects are to be detected in the measuring field.</p> <p>Note: Only possible after teach area has been set up.</p> <div style="display: flex; justify-content: space-around;"> <div style="text-align: center;"> <p>Example: Setting “one”</p>  <p>Is regarded as one object (beam 1–6) with one hole (beam 3–4).</p> </div> <div style="text-align: center;"> <p>Setting “several”</p>  <p>Is regarded as two different objects.</p> </div> </div>

* Press and hold the + or - key in order to scroll quickly through the numbers.

7.4. E/A2

After selecting the pin function, one of the following menus appears.

7.4.1 E Teach

If the input is activated, external Teach-In is executed for A1 Switch. Which Teach-In mode will be used for external Teach-In must be selected under "A1 Switch" – "T External".

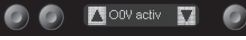
Function	Description
With Ub 	Use as a Non-Inverted Input The output is normally open or connected to "0 V" supply power. The input's function is triggered by applying a voltage of greater than 7 V.
With 0 V 	Use as a Non-Inverted Input The input is normally connected to supply power of greater than 7 V. The input's function is triggered by disconnecting it or applying a voltage of less than 7 V.

7.4.2 E Setup

If the input is activated, the Light Barrier is set up automatically. Setup can also be initiated via the menu (see section 7.14).



Settings for I Setup are entered in the same way as for I Teach (see section 7.4.1).

7.4.3 A2 Switch

Settings for A2 Switch are entered in the same way as for A1 Switch (see section 7.3).

7.4.4 A2 Error

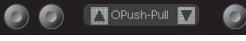
The error output is switched as soon as an error is detected (see section 6.8).

Function	Description
PNP/Push-Pull  	Selecting the Output Type The PNP or push-pull output type can be selected with the help of the ▼ and ▲ keys, and selection is acknowledged by pressing the enter key.
NO/NC 	The error output is set up as normally open or normally closed by pressing the NO or the NC key. The respective circuit diagram is displayed.

7.5. Analog

The analog input is set up here. One of the following Teach-In modes can be selected:

7.5.1 Position

Top Position:

The position of the uppermost interrupted beam within the measuring field is read out from the analog output as an appropriate voltage or current signal. The respective positions are taught in for 0 V/4 mA and 10 V/20 mA.

Example:

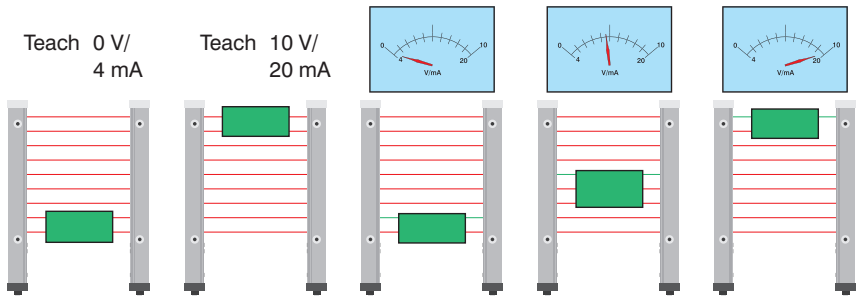

Bottom Position:

The position of the bottommost interrupted beam within the measuring field is read out from the analog output as an appropriate voltage or current signal. The respective positions are taught in for 0 V/4 mA and 10 V/20 mA.

Example:

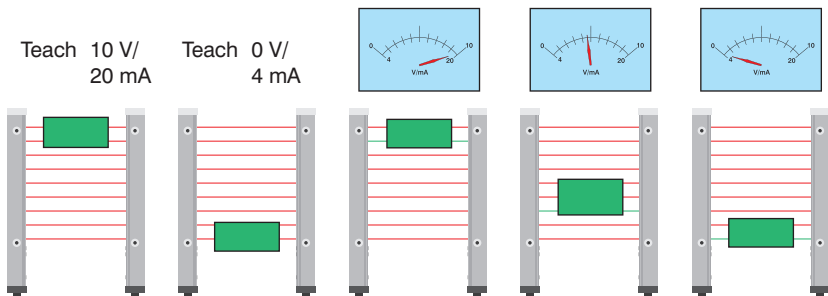

Size:

The number of interrupted beams within the measuring field is read out from the analog output as an appropriate voltage or current signal. The respective numbers of beams are taught in for 0 V/4 mA and 10 V/20 mA.

Example:

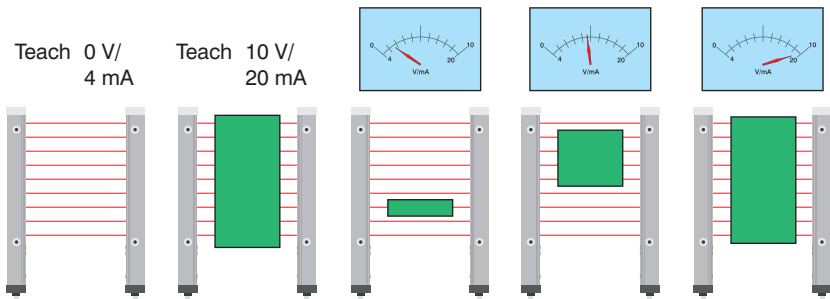

7.5.2 Web Edge

Web Edge, Independent of Position:

An object is taught in at any position within the measuring field. This position then corresponds to 5 V/12 mA at the analog output. If the top position is changed, voltage or current is reduced/increased accordingly, and if the bottom position is changed, voltage or current is increased/reduced accordingly. Change in V/mA per interrupted beam can be readjusted via a menu.

Example:

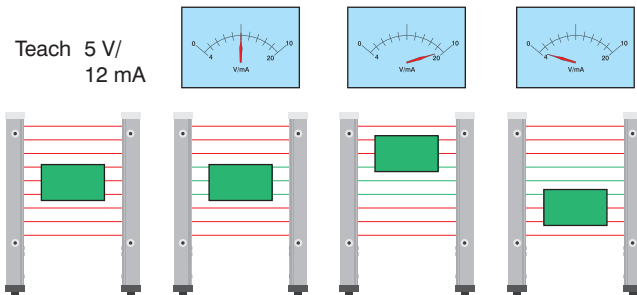





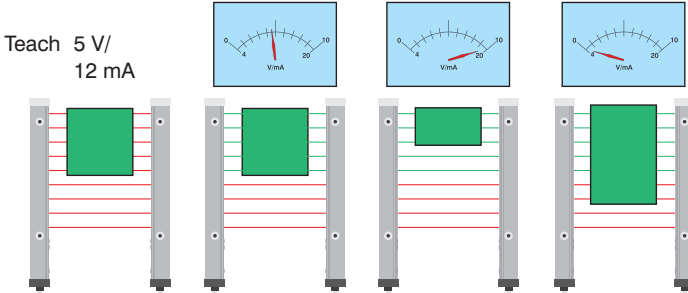

Web edge, Position Dependent:

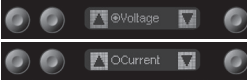
An object is taught in which protrudes into the measuring field from the top. This position then corresponds to 5 V/12 mA at the analog output. If the top position is changed, voltage or current is reduced/increased accordingly, and if the bottom position is changed, voltage or current is increased/reduced accordingly. Change in V/mA per interrupted beam can be readjusted via a menu.

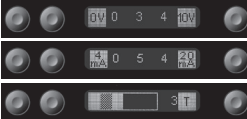
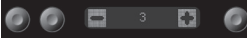
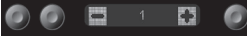
Example:

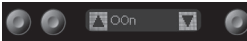

Function	Description
Mode U/I	Analog Output as Current or Voltage Output
	Voltage (0 to 10 V) or current (4 to 20 mA) is selected by pressing the ▲ and ▼ keys and acknowledged by pressing the enter key.
Mode Pos./Size/Web edge	Select Teach Mode
	The position, size or web edge teach mode is selected by pressing the ▲ and ▼ keys, and acknowledged by pressing the enter key.
Teach-In	Teaching In Voltage or Current Values
	In the position and size teach modes, momentary position/size is assigned to a voltage value of 10 V or a current value of 20 mA by pressing the 10 V or 20 mA key.
	Momentary position/size is assigned to a voltage value of 0 V or a current value of 4 mA by pressing the 0 V or the 4 mA key.
	If necessary, the assigned positions/sizes can be readjusted with the help of menu items “At 0 V” or “At 10 V”.
	In the web edge teach mode, momentary position is assigned to a voltage value of 5 V or a current value of 12 mA by pressing the 5 V or 12 mA key.
with 0 V/4 mA	Position/Size at 0 V/4 mA
	The position/size assigned to either 0 V or 4 mA is readjusted by pressing the + or – key.
	Note: only possible after position or size Teach-In has been completed.
with 10 V/20 mA	Position/Size at 10 V/20 mA
	The position/size assigned to either 10 V or 20 mA is readjusted by pressing the + or – key.
	Note: only possible after position or size Teach-In has been completed.
V/mA per Beam	Readjusting V/mA per Beam
	The required change to voltage/current per additionally interrupted beam is readjusted by pressing the + or – key.
	The desired value must be selected as a negative number in order to negate the change to V/mA per beam.
	Note: only possible after web edge Teach-In has been completed.

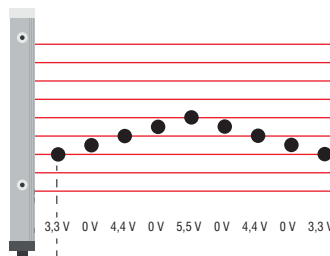
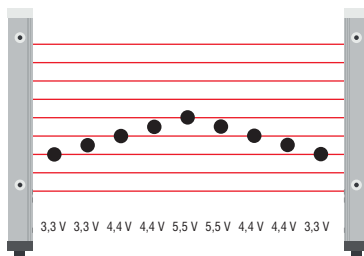
Function	Description
<div style="border: 1px solid black; padding: 5px; margin-bottom: 5px;">  </div> <div style="border: 1px solid black; padding: 5px;">  </div>	<p data-bbox="296 188 1083 215">Buffering of the analog values</p> <p data-bbox="296 223 1083 359">You select ON or OFF by pressing the ▲ or ▼ buttons and make the settings by pressing the ENTER button. With this function the values of the voltage or current is buffered until a new value is detected. Thus, the last valid value and not 0 V or 4 mA applies in the case of objects that are less than the beam spacing and are between the beams.</p> <p data-bbox="296 383 1083 438">Note: Only possible after Teach Position and Teach web edge independent of position.</p> <p data-bbox="296 462 1083 486">Example: A cable moves through a measuring field.</p> <div style="display: flex; justify-content: space-around; align-items: flex-end;"> <div data-bbox="296 510 638 798" style="text-align: center;"> <p>Off</p>  <p>3,3 V 0 V 4,4 V 0 V 5,5 V 0 V 4,4 V 0 V 3,3 V</p> </div> <div data-bbox="705 510 1083 798" style="text-align: center;"> <p>On</p>  <p>3,3 V 3,3 V 4,4 V 4,4 V 5,5 V 5,5 V 4,4 V 4,4 V 3,3 V</p> </div> </div> <p data-bbox="347 821 896 842" style="text-align: center;">Position of the cable in the measuring field with corresponding analog value</p>

7.6. Blanking

Various applications require that certain objects protrude into the measuring field during the entire duration of operation. In order to accommodate operating conditions of this sort, certain beams (which are always obstructed) can be blanked. Blanked beams are not evaluated and their status is ignored.

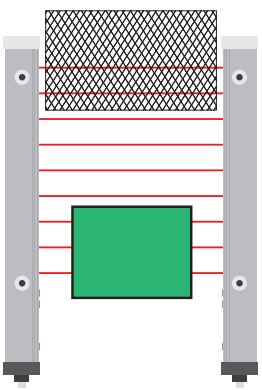

Beam numbering (see section 6.4) is not changed by blanking.

Function	Description
Blanking	Blanking Beams
	Momentarily interrupted beams are blanked by pressing the B key. Blanking is canceled by pressing the Off key.

7.7. E/A Test

Inputs and outputs can be tested with this function. The inputs and outputs are changed to this end, independent of their settings.

In this way it can be determined, for example, whether or not the inputs and outputs are correctly connected to a controller.

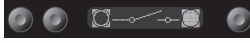
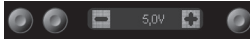
Function	Description
Test A1	Testing A1 Switch
	The output can be switched on and off, independent of its settings, by pressing the ▲ and ▼ keys.
Test E/A2	Testing E/A2
	E/A2 can be tested depending upon whether it's set up as an input or an output. If E/A2 is setup as an output, the test functions in the same was as for test A1. If E/A2 is set up as an input and if a voltage of greater than 7 V DC is applied, regardless of its settings, the display indicates whether or not the input is activated.
Test Analog	Testing the Analog Output
	By pressing the + or - key, a voltage/current can be selected for the analog output, regardless of its settings.

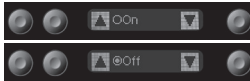

7.8. Expert Menu

With the help of the expert menu, the menu can be set up such that either all menu items and settings are displayed, or only those which are most important for the user.

Function	Description
Expert Menu	Activating/Deactivating the Expert Menu
	On or Off is selected by pressing the ▲ and ▼ keys, and the selection is acknowledged by pressing the enter key. On: All sub-menus and settings are displayed in the menu. Off (default): Only the sub-menus and settings which are most important for the user are displayed in the menu. The menu items which are suppressed through the use of this setting are identified with an asterisk (*) in the menu plan.

7.9. Display Definition

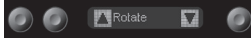
The display is set up with the help of the display menu.

Function	Description
Rotate 	Rotating the Display The display is rotated 180° by pressing the enter key. The display can be returned to its original position by pressing the same key once again.
Intensity 	Adjusting Display Brightness After pressing the ▶ and ◀ keys, the menu appears immediately with the selected brightness setting (Min, Medium or Max). In setting power save the display turns off after 60 seconds. In setting screensaver, the display inverts every 60 seconds. The brightness is set to normal during these settings. Selection is acknowledged by pressing the enter key.
Display def. 	Definition der Display Anzeige Bar Graph There are two designs for the bar graph which can be selected with the ▲ and ▼ keys, and acknowledged with the enter key: <ul style="list-style-type: none"> • Mode 1 (default): With markings at the side for the individual beams. Every fifth beam is bold. • Mode 2: Without markings at the side and with frame. Display Elements The elements which will appear in the display mode can be selected with the ▲ and ▼ keys and acknowledged by pressing the enter key. Displayable elements include: <ul style="list-style-type: none"> • Bar graph (default) • Output 1 (default) • E/A2 • Analog value (default) The bar graph is displayed larger or smaller depending upon the number of selected elements.

7.10. Language

The desired menu language can be selected in the “Language” menu.

Function	Description
Language	Selecting the Display Language
	<p>The desired display language is selected by pressing the ▲ and ▼ keys, and is acknowledged by pressing the enter key. The desired language appears in the menus as soon as it has been selected.</p> <p><u>Selectable languages:</u></p> <ul style="list-style-type: none"> • German • English (Default) • French • Spanish • Italian <p>The display language must be selected after initial start-up, and after each reset.</p>

7.11. Information

The following information regarding the sensor is displayed in the “Info” menu:

- Sensor type
- Sensor version

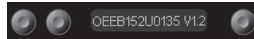





7.12. Reset

Sensor settings can be returned to their default values with the help of the “Reset” menu.

Function	Description
Reset	Default setting
	<p>All of the selected sensor settings are returned to their default values by pressing the R key.</p>

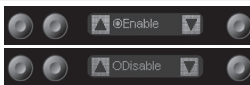
7.13. Password

The sensor can be locked by entering a password in the “Password” menu, so that setting can not be readjusted.

Function	Description
Enable	Switching the Password Function On or Off
	“Enable” or “Disable” can be selected with the ▲ and ▼ keys. The password function is thus switched on or off. If the password function is activated, sensor operation is disabled after supply power has been interrupted. Immediate disabling is also possible with the help of the “Disable” submenu.
Enter	Password Entry for Enabling the Sensor
	The password for enabling the sensor is selected with the + or – key.* Selection is acknowledged by pressing the enter key. The password is set to “0” upon shipment from the factory.
Change	Changing the Password
	The desired new password is selected with the + or – key.* Selection is acknowledged and the password is changed by pressing the enter key.
Disabling	Disabling the Sensor
	The sensor is disabled without interrupting supply power. The sensor is disabled by pressing the enter key, and the password entry window is displayed immediately. The sensor is switched to the display mode after approximately 30 seconds. A password must be entered in order to continue using the sensor.

* Press and hold the + or – key in order to scroll quickly through the numbers

Notes regarding password functions:

If the password function has been activated. The password must be entered each time supply power to the sensor is interrupted. After pressing a key, the menu is automatically switched to the password entry mode.

After the password has been correctly entered, the entire menu is enabled and the sensor can be operated.

- The password function is deactivated upon shipment from the factory.
- The password is set to “0” upon shipment from the factory.
- Passwords can be selected within a range of 0000 to 9999.

It must be assured that the newly selected password is noted before the password is changed. If the password is forgotten, it must be overwritten with a master password. The master password can be requested by e-mail from support@wenglor.com.

7.14. Start Setup

The sensitivity of the receiver to the emitter is set automatically here.

Function	Description
Setup	Set sensitivity
	The intensity of the individual beams is automatically adjusted and the Light Curtain is set up after pressing the T key. Setup procedure progress is indicated at the display (see also chapter 6.1 on page 10.).

8. IO-Link Parameter and Process data

Addressing via IO-Link

The Index is set to "1" at all times. Thereby the Direct Parameter Page can be reached, where then the several Parameters can be set by the Subindexes.

Subindex "0"	→ read all Parameters	
Subindex "1"	→ Parameter 0	read/write
Subindex "2"	→ Parameter 1	read/write
...

Process bytes

Process bytes 0

Bit 0	Analog Mode, Voltage/Current	0 = Voltage 1 = Current
Bit 1	Analog Output Bit 0	
Bit 2	Analog Output Bit 1	
Bit 3	Analog Output Bit 2	
Bit 4	Analog Output Bit 3	Analog Value As %
Bit 5	Analog Output Bit 4	
Bit 6	Analog Output Bit 5	
Bit 7	Analog Output Bit 6	

Process bytes 1

Bit 0	Output Status, Output 1	0 = Not Switched 1 = Switched
Bit 1	Output Status, Output 2	0 = Not Switched 1 = Switched
Bit 2	Beams, Bit 0	
Bit 3	Beams, Bit 1	
Bit 4	Beams, Bit 2	Function can be Selected with the Beams Function
Bit 5	Beams, Bit 3	(Parameter 11 Bit 3-5)
Bit 6	Beams, Bit 4	
Bit 7	Beams, Bit 5	

Parameter

Main Page

→ General Settings

Parameter 0

Bit 0	Reset to delivery status	1 = Do reset
Bit 1	Display Language	00 = German, 01 = English
Bit 2	Display Language	10 = French, 11 = Spanish
Bit 3	Rotating the Display by 180°	1 = rotate
Bit 4	Display Intensity	00 = Min., 01 = Medium, 10 = Max.
Bit 5	Display Intensity	11 = Screensaver
Bit 6	Lock Sensor	1 = Sensor is locked
Bit 7	Switch to	1 = Configuration page

Is Bit 7 in Parameter 0 set to „1“, more Configuration Pages can be reached. For this purpose the corresponding address of the Configuration Page (in brackets) is set to parameter 0 Bit 0-6.

Parameter 1

Bit 0	PNP/Push-Pull, Output 1	0 = PNP, 1 = Push-Pull
Bit 1	Output 1 NO/NC	0 = NC, 1 = NO
Bit 2	PNP/Push-Pull, Output 2	0 = PNP, 1 = Push-Pull
Bit 3	Output 2 NO/NC	0 = NC, 1 = NO
Bit 4	Function E/A2 Input	0 = setup input, 1 = Teach-In input
Bit 5	Function E/A2 Output	0 = Switching Output, 1 = Error Output
Bit 6	Input activation	0 = active with Ub , 1 = active with 0 V
Bit 7	E/A2 Input/Output	0 = Output, 1 = Input

Parameter 2

Bit 0	Start Setup	1 = start setup
Bit 1	Start Teach-In, output 1	1 = start Teach-In
Bit 2	Start Teach-In, output 2	1 = start Teach-In
Bit 3	Digital Teach-In Mode	00 = Beams, 01 = Pattern
Bit 4	Digital Teach-In Mode	10 = two-step, 11 = range
Bit 5	Teach step	1 = 2 nd Teach Point/End of Dynamic Teach
Bit 6	Independent of Position/ Position Dependent	0 = Independent of Position, 1 = Position Dependent
Bit 7	Expert Menu	0 = Off, 1 = On

Parameter 3

Bit 0	Analog Mode, Voltage/Current	0 = Voltage, 1 = Current
Bit 1	Start teach analog 0 V/4 mA	1 = start teach
Bit 2	Start teach analog 10 V/20 mA	1 = start teach
Bit 3	Start teach analog 5 V/12 mA	1 = start teach
Bit 4	Analog Teach-In mode	00 = size, 01 = position
Bit 5	Analog Teach mode	10 = web edge
Bit 6	Top/bottom position	0 = top, 1 = bottom
Bit 7	Web Edge, Independent of Position/Position Dependent	0 = Independent of Position, 1 = Position Dependent

- Parameter 4** High Byte On-Delay Output 1 in ms
- Parameter 5** Low Byte On-Delay Output 1 in ms
- Parameter 6** High Byte On-Delay Output 1 in ms
- Parameter 7** Low Byte On-Delay Output 1 in ms
- Parameter 8** High Byte Impulse Duration Output 1 in ms
- Parameter 9** Low Byte Impulse Duration Output 1 in ms
- Parameter 10** Number of Beams During Beam Teach-In

- Parameter 11**
- Bit 0 Event During Beam Teach-In 0 = Interrupted Beams, 1 = Uninterrupted Beams
- Bit 1 Beam Teach-In Condition 00 = "=", 01 = ">="
- Bit 2 Beam Teach-In Condition 10 = "<="
- Bit 3 Beam function
- Bit 4 Beam function see table
- Bit 5 Beam function

Parameter Value	Function
000	Number (total) of uninterrupted beams
001	Number (total) of interrupted beams
010	First uninterrupted beam (beam number)
011	First interrupted beam (beam number)
100	Last uninterrupted beam (beam number)
101	Last interrupted beam (beam number)
110	Number of consecutive uninterrupted beams*
111	Number of consecutive interrupted beams*

* The number of the largest group of consecutive beams within the measuring field is read out.

- Bit 6 External Teach Mode 00 = Pattern, Position Independent
- Bit 7 External Teach Mode 01 = Pattern, Position Dependent, 11 = Range

Configuration page (0x80)

→ General sensor information

- Parameter 1** Serial Number, Byte 1
- Parameter 2** Serial Number, Byte 2
- Parameter 3** Serial Number, Byte 3
- Parameter 4** Serial Number, Byte 4
- Parameter 5** DeviceID Byte 1
- Parameter 6** DeviceID Byte 2
- Parameter 7** DeviceID Byte 3
- Parameter 8** Revision level
- Parameter 9** Sensor Password High Byte
- Parameter 10** Sensor Password Low Byte

Configuration page (0x81)

→ Delay times, output 2

Parameter 1	High Byte On-Delay Output 2 in ms
Parameter 2	Low Byte On-Delay Output 2 in ms
Parameter 3	High Byte On-Delay Output 2 in ms
Parameter 4	Low Byte On-Delay Output 2 in ms
Parameter 5	High Byte Impulse Duration Output 2 in ms
Parameter 6	Low Byte Impulse Duration Output 2 in ms
Parameter 7	
Parameter 8	
Parameter 9	
Parameter 10	

Configuration page (0x82) only read

→ Read out settings, output 1

Parameter 1

Bit 0	Event During Beam Teach output 1	0 = Interrupted Beams, 1 = Uninterrupted Beams
Bit 1	Beam Teach Output 1 Condition	00 = "=", 01 = ">="
Bit 2	Beam Teach Output 1 Condition	10 = "<="
Bit 3	Digital Teach mode Output 1	00 = Beams, 01 = Pattern
Bit 4	Digital Teach mode Output 1	10 = two-step, 11 = range
Bit 5	Independent of position/ position dependent, output 1	0 = independent of position, 1 = position dependent
Bit 6		
Bit 7		

Parameter 2 Number of beams during beam Teach-In, output 1

Parameter 3 Beginning of range (beam number) for range Teach-In, output 1

Parameter 4 Range width (number of beams) for range Teach-In, output 1

Parameter 5 Size of object 1 (first to last interrupted beam) for two-step Teach-In, output 1

Parameter 6 Size of object 2 (first to last interrupted beam) for two-step Teach-In, output 1

Parameter 7

Bit 1	Tolerance, output 1	00 = -1, 01 = 0
Bit 2	Tolerance, output 1	10 = +1, 11 = +/-1
Bit 3		
Bit 4		
Bit 5		
Bit 6		
Bit 7		

Parameter 8

Bit 0	Number of objects during Teach-In Range output 1	0 = one 1 = several
-------	--	------------------------

Parameter 9

Parameter 10

Configuration page (0x83)

→ Read out settings for output 2

Parameter 1

Bit 0	Event During Beam Teach output 2	0 = Interrupted Beams, 1 = Uninterrupted Beams
Bit 1	Beam Teach Output 2 Condition	00 = "=", 01 = ">="
Bit 2	Beam Teach Output 2 Condition	10 = "<="
Bit 3	Digital Teach mode Output 2	00 = Beams, 01 = Pattern
Bit 4	Digital Teach mode Output 2	10 = two-step, 11 = range
Bit 5	Independent of position/ position dependent, output 1	0 = independent of position, 1 = position dependent
Bit 6		
Bit 7		

Parameter 2

Number of beams during beam Teach-In, output 2

Parameter 3

Beginning of range (beam number) for range Teach-In, output 2

Parameter 4

Range width (number of beams) for range Teach-In, output 2

Parameter 5

Size of object 1 (first to last interrupted beam) for two-step Teach-In, output 2

Parameter 6

Size of object 2 (first to last interrupted beam) for two-step Teach-In, output 2

Parameter 7

Bit 1	Tolerance output 2	00 = -1, 01 = 0
Bit 2	Tolerance output 2	10 = +1, 11 = +/-1
Bit 3		
Bit 4		
Bit 5		
Bit 6		
Bit 7		

Parameter 8

Bit 0	Number of objects during Teach-In Range output 2	0 = one 1 = several
-------	--	------------------------

Parameter 9

Parameter 10

Configuration page (0x84) only read

→ Read out taught in pattern from output 1

Parameter 1

Object size during pattern Teach-In, output 1

Parameter 2

Number of interrupted beams during pattern Teach-In, output 1

Parameter 3

Beam pattern for pattern Teach-In, output 1, beams 1 through 8

Parameter 4

Beam pattern for pattern Teach-In, output 1, beams 9 through 16

Parameter 5

Beam pattern for pattern Teach-In, output 1, beams 17 through 24

Parameter 6

Beam pattern for pattern Teach-In, output 1, beams 25 through 32

Parameter 7

Beam pattern for pattern Teach-In, output 1, beams 33 through 40

Parameter 8

Beam pattern for pattern Teach-In, output 1, beams 41 through 48

Parameter 9

Beam pattern for pattern Teach-In, output 1, beams 49 through 56

Parameter 10

Beam pattern for pattern Teach-In, output 1, beams 57 through 64

Example:

Parameter 1: size object: 2 beams

- Bit 0 = 0
- Bit 1 = 1
- Bit 2 = 0
- Bit 3 = 0
- Bit 4 = 0
- Bit 5 = 0
- Bit 6 = 0
- Bit 7 = 0

Parameter 2: Number of interrupted beams: 2

- Bit 0 = 0
- Bit 1 = 1
- Bit 2 = 0
- Bit 3 = 0
- Bit 4 = 0
- Bit 5 = 0
- Bit 6 = 0
- Bit 7 = 0

Parameter 3: Beam pattern

- Bit 0 = 0 (1st Beam)
- Bit 1 = 0 (2nd Beam)
- Bit 2 = 1 (3rd Beam)
- Bit 3 = 1 (4th Beam)
- Bit 4 = 0 (5th Beam)
- Bit 5 = 0 (6th Beam)
- Bit 6 = 0
- Bit 7 = 0

Parameters 4 through 10 analogously for Light Barriers with more beams.

Configuration page (0x85) only read

→ Read out taught in pattern from output 2

Parameter 1	Object size during pattern Teach-In, output 2
Parameter 2	Number of interrupted beams during pattern Teach-In, output 2
Parameter 3	Beam pattern for pattern Teach-In, output 2, beams 1 through 8
Parameter 4	Beam pattern for pattern Teach-In, output 2, beams 9 through 16
Parameter 5	Beam pattern for pattern Teach-In, output 2, beams 17 through 24
Parameter 6	Beam pattern for pattern Teach-In, output 2, beams 25 through 32
Parameter 7	Beam pattern for pattern Teach-In, output 2, beams 33 through 40
Parameter 8	Beam pattern for pattern Teach-In, output 2, beams 41 through 48
Parameter 9	Beam pattern for pattern Teach-In, output 2, beams 49 through 56
Parameter 10	Beam pattern for pattern Teach-In, output 2, beams 57 through 64

Function as per configuration page 0x84, parameters 1–10

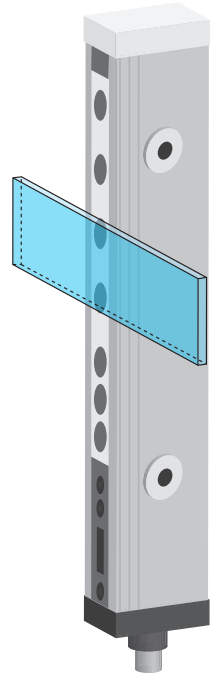

Configuration page (0x86)

→ Read-out analog output settings

Parameter 1

Bit 0	Analog mode, voltage/current	0 = voltage, 1 = current
Bit 1	Analog Teach-In mode	00 = size, 01 = position
Bit 2	Analog Teach-In mode	10 = web edge
Bit 5	Independent of position/ web edge position dependent/independent	0 = independent of position, 1 = position dependent
Bit 4	Top/bottom position	0 = top, 1 = bottom
Bit 5	Buffering	0 = Off, 1 = On
Bit 6		
Bit 7		

Parameter 2 V/mA per beam for analog web edge

Parameter 3 Measure size 1 for analog size

Parameter 4 Measure size 1 for analog size

Parameter 5

Parameter 6

Parameter 7

Parameter 8

Parameter 9

Parameter 10

Configuration page (0x87)

→ Read out blanking/configure display

Parameter 1	Beam pattern for blanking of beams 1 through 8
Parameter 2	Beam pattern for blanking of beams 9 through 16
Parameter 3	Beam pattern for blanking of beams 17 through 24
Parameter 4	Beam pattern for blanking of beams 25 through 32
Parameter 5	Beam pattern for blanking of beams 33 through 40
Parameter 6	Beam pattern for blanking of beams 41 through 48
Parameter 7	Beam pattern for blanking of beams 49 through 56
Parameter 8	Beam pattern for blanking of beams 57 through 64

Function as per configuration page 0x84, parameters 3-10

Parameter 9

Bit 0		
Bit 1	Display Intensity	1 = Powersave
Bit 2	Bar graph mode	0 = mode 1, 1 = mode 2
Bit 3	Display element: bar graph	1 = display
Bit 4	Display element: Output 1	1 = display
Bit 5	Display element: analog value	1 = display
Bit 6	Display element: E/A2	1 = display
Bit 7		

Parameter 10

Configuration page (0x89)

→ Read out momentary beam pattern

Parameter 1	Momentary beam pattern for beams 1 through 8
Parameter 2	Momentary beam pattern for beams 9 through 16
Parameter 3	Momentary beam pattern for beams 17 through 24
Parameter 4	Momentary beam pattern for beams 25 through 32
Parameter 5	Momentary beam pattern for beams 33 through 40
Parameter 6	Momentary beam pattern for beams 41 through 48
Parameter 7	Momentary beam pattern for beams 49 through 56
Parameter 8	Momentary beam pattern for beams 57 through 64

Function as per configuration page 0x84, parameters 3–10

9. Maintenance Instructions

- This wenglor Sensor is maintenance-free.
- It is advisable to clean the lens and the display, and to check the plug connections at regular intervals.
- Do not clean with solvents or cleansers which could damage the device.

10. Proper Disposal

wenglor sensoric gmbh does not accept the return of unusable or irreparable products. Respectively valid national waste disposal regulations apply to product disposal.