

X1TA

High Performance Distance Sensors



Operating Instructions

Index

1. Proper Use	4
2. Safety Precautions	4
2.1. Safety Precautions	4
2.2. Laser/LED warning	4
3. EU Declaration of Conformity	4
4. Technical Data	5
4.1. Connecting the Sensors	7
4.2. Housing Dimensions	8
4.3. The Control Panel	8
4.4. Complementary Products (see catalog)	8
5. Mounting Instructions	9
6. Initial Start-Up	9
6.1. Initial Start-Up	9
6.2. Default Settings	10
7. Functional Overview	11
7.1. RUN	12
7.2. Pin Function	12
7.3. A1/A2/A3 Switch	12
7.4. A3 Error F/A3 Input	15
7.4.1. A3 Error	15
7.4.2. A3 Input	15
7.5. A1 Analog/Analog	16
7.6. Offset	17
7.7. Measuring rate	19
7.8. Laser	19
7.9. Read-Out	20
7.10. Interface (does apply to X1TA101MHT88)	21
7.11. Display	24
7.12. Language	24
7.13. Info	24
7.14. Reset	24
7.15. Password	25

8. More Settings and Queries via the RS-232 Interface	27
8.1. Remote Control via a Terminal Program	28
8.2. Remote Control with Interface Commands	29
9. Maintenance Instructions	29
10. Proper Disposal	29

1. Proper Use

This wenglor product has to be used according to the following functional principle:

High Performance Distance Sensors

This group brings together the most powerful sensors for distance measurement, which work in reflex mode according to different principles. High performance distance sensors are particularly fast and precise, and demonstrate their high efficiency over large working ranges. They are ideally suited for demanding applications. Even black and shiny objects are reliably detected. Ethernet technology is integrated into selected sensors.

2. Safety Precautions

2.1. Safety Precautions

- This operating instruction is part of the product and must be kept during its entire service life.
- Read this operating instruction carefully before using the product.
- Installation, start-up and maintenance of this product should only be carried out by trained personnel.
- Tampering with or modifying the product is not permissible.
- Protect the product against contamination during start-up.
- Not a safety component in accordance with the EU Machinery Directive.

2.2. Laser/LED warning



Class Laser 1 (EN 60825-1)

Observe all applicable standards and safety precautions.

3. EU Declaration of Conformity

The EU declaration of conformity can be found on our website at www.wenglor.com in download area.



UL Certified only in combination with the following wenglor connection cables: S23, S35, S88.

4. Technical Data

Optical Data	X1TA101MHT88	X1TA101MHV80	X1TA100QXT3
Working range	0,2...100,2 m	0,2...100,2 m	0,1...10,2 m
Working range analog	0,2...100,2 m	0,2...100,2 m	0,2...10,2 m
Measuring range	100 m	100 m	10 m
Reference reflector/reflector sheet	4 × RQ100BA	4 × RQ100BA	RQ100BA
Linearity	0,05 %	0,05 %	0,5 %
Switching hysteresis	13...50 mm	13...50 mm	3...20 mm
Light Source	Laser (rot)	Laser (rot)	Laser (rot)
Wave Length	660 nm	660 nm	660 nm
Service life (amb. temp. = 25 °C)	100000 h	100000 h	100000 h
Laser Protection Class (EN60825-1)	1	1	1
Beam Divergence	< 2 mrad	< 2 mrad	< 2 mrad
Electrical Data			
Supply Voltage*	18...30 V DC	18...30 V DC	18...30 V DC
Current Consumption (operating voltage = 24 V)	< 100 mA	< 100 mA	< 100 mA
Switching Frequency	50 Hz	50 Hz	50 Hz
Response Time	10...200 ms	10...200 ms	10...200 ms
Measuring rate	1...100/s	1...100/s	1...100/s
Temperature Drift	<0,5 mm/k	<0,5 mm/k	<0,2 mm/k**
Temperature Range	-25...60 °C	-25...60 °C	-25...60 °C
Number of switching outputs, configurable as PNP, NPN or push-pull	2	3	2
Switching Output Voltage Drop	< 2,5 V	< 2,5 V	< 2,5 V
Switching Output Switching Current	200 mA	200 mA	200 mA
Error Output	yes	yes	yes
Error Output Switching Current	200 mA	200 mA	200 mA
Analog Output	0...10 V	0...10 V	0...10 V
Current Load Voltage Output	<1 mA	<1 mA	<1 mA
Analog Output	4...20 mA	4...20 mA	4...20 mA
Current Output Load Resistance	<500 Ω	<500 Ω	<500 Ω
Short Circuit Protection	yes	yes	yes
Reverse Polarity Protection	yes	yes	yes
Overload Protection	yes	yes	yes
Interface	RS-232	-	-
Configuration	8 N 1	-	-
Resolution	4...20 mm	4...20 mm	2...6 mm
Mechanical Data			
Adjustment	Teach-In	Teach-In	Teach-In
Housing	Plastic	Plastic	Plastic
Protection	IP68	IP68	IP68
Connection	M12 × 1	M12 × 1	M12 × 1
Protection Class	III	III	III
FDA Accession Number	0920382-000		

* Supply voltage residual ripple may not exceed 10 % (within the specified voltage range).

**Temperature Drift: 0,4 mm/k at ambient temperature < -10 °C and > 50 °C

Measuring Range:

The Sensors' measuring range is determined by object remission and the size of the reflector.

Type of Reflector	Mounting Distance	
	X1TA101	X1TA100
RQ100BA	5...100 m*	0,1...10 m
	0,2...10 m	
RF505	0,2...40 m*	0,1...10 m
RF508	0,2...40 m*	0,1...10 m
RF258	0,2...40 m**	0,1...10 m
ZRAF07K01	0,2...40 m	0,1...10 m
ZRAF08K01	0,2...40 m	0,1...10 m
ZRDF03K01	0,2...40 m	0...10 m
ZRDF10K01	0,2...100 m*	0...10 m
	0,2...40 m	

* when using 4 reflectors/reflex foils

** when using 2 reflectors/reflex foils

In order that the Sensor functions properly, the whole light spot of the Sensor has to hit the reflector. Please chose the suitable reflector!

Light Spot Diameter

Working Distance	0	10 m	40 m	100 m
Light Spot Diameter X1TA	5 mm	< 20 mm	< 80 mm	< 200 mm

Dependence of Hysteresis and Resolution on the Measuring rate on white (90 % Remission)

Selected sampling rate in Hz	X1TA101		X1TA100	
	Default setting for min. hysteresis in mm	Resolution in mm	Default setting for min. hysteresis in mm	Resolution in mm
100	40	20	20	6
50	35	14	15	5
20	30	12	10	4
10	25	10	8	4
5	20	8	6	3
2	15	6	4	3
1	13	4	3	2

4.1. Connecting the Sensors

X1TA101MHV80

514

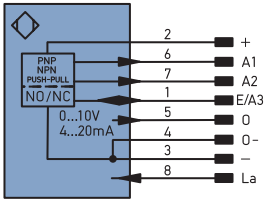

X1TA101MHT88

516

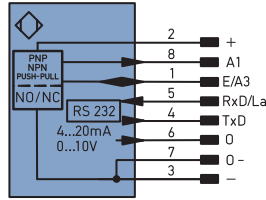

X1TA100QXT3

755

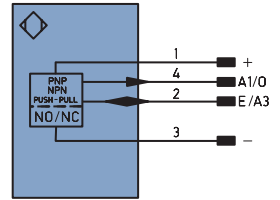

Switching laser light off via pin connection:

If the "La" pin is open or connected to negative, the laser is on.

If positive voltage is applied, the laser is off.

Connecting Cables M12 × 8, 8-pin

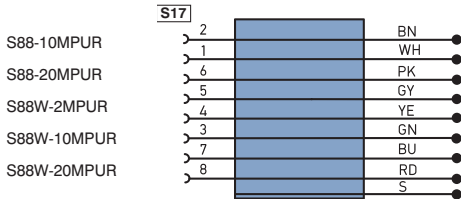

Connecting Cables M12 × 8, 8-pin

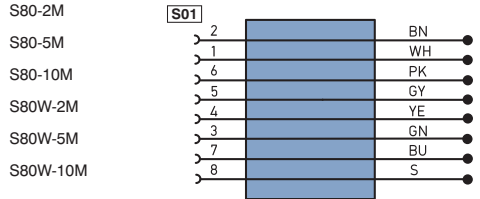

Connecting Cables M12 × 1, 4-pin

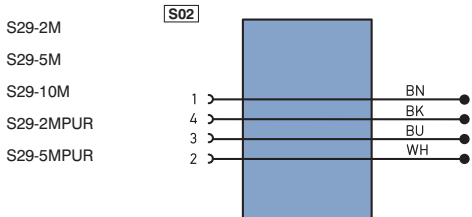

Connecting Cables M12 × 1, 4-pin

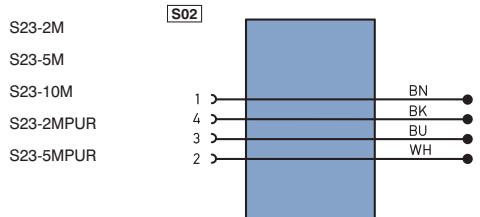

Legend

+	Supply Voltage +	PT	Platinum measuring resistor
-	Supply Voltage 0 V	nc	not connected
~	Supply Voltage (AC Voltage)	U	Test Input
A	Switching Output (NO)	U	Test Input inverted
A	Switching Output (NC)	W	Trigger Input
V	Contamination/Error Output (NO)	O	Analog Output
V	Contamination/Error Output (NC)	O-	Ground for the Analog Output
E	Input (analog or digital)	BZ	Black Discharge
T	Teach Input	A/W	Valve Output
Z	Time Delay (activation)	a	Valve Control Output +
S	Shielding	b	Valve Control Output 0 V
RxD	Interface Receive Path	SY	Synchronization
TxD	Interface Send Path	E+	Receiver-Line
RDY	Ready	S+	Emitter-Line
GND	Ground	±	Grounding
CL	Clock	SR	Switching Distance Reduction
E/A	Output/Input programmable	Rx+/-	Ethernet Receive Path
IO-link	IO-link	Tx+/-	Ethernet Send Path
PoE	Power over Ethernet	Bu	Interfaces-Bus A(+)/B(-)
IN	Safety Input	La	Emitted Light disengageable
DSSD	Safety Output	Mag	Magnet activation
Signal	Signal Output	RES	Input confirmation
EN _D +/-	Ethernet Gigabit bidirect. data line (A-D)	EDM	Contactor Monitoring
EN _{Nonssz}	Encoder 0-pulse 0-0 (TTL)	EN _{ssz} A	Encoder A/A (TTL)
		EN _{ssz} B	Encoder B/B (TTL)

ENA	Encoder A
ENB	Encoder B
AMIN	Digital output MIN
AMAX	Digital output MAX
AOK	Digital output OK
SY in	Synchronization In
SY OUT	Synchronization OUT
BRT	Brightness output
M	Maintenance
rsv	reserved

Wire Colors according to DIN IEC 757

BK	Black
BN	Brown
RD	Red
OG	Orange
YE	Yellow
GN	Green
BU	Blue
VT	Violet
GY	Grey
WH	White
PK	Pink
GNYE	Green/Yellow

4.2. Housing Dimensions

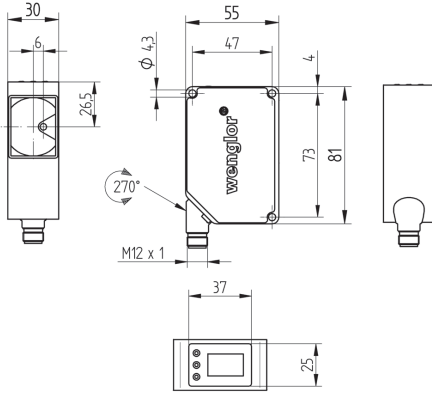

Screw M4 = 0,5 Nm

4.3. The Control Panel

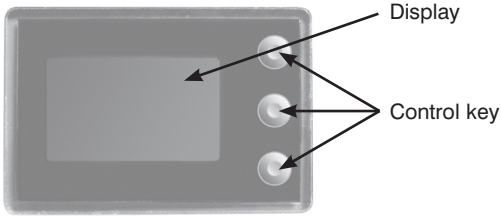

4.4. Complementary Products (see catalog)

wenglor offers Connection Technology for field wiring.

Suitable Mounting Technology No.

340

Suitable Connection Technology No.

2

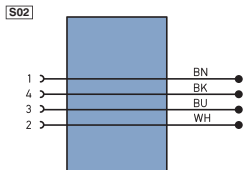

80

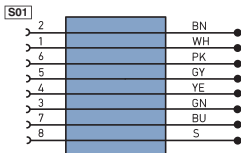

88

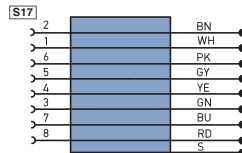

Analog Evaluation Unit AW02

Reflector, Reflector Foil

Protection Housing Set ZST-NN-02

5. Mounting Instructions

All applicable electrical and mechanical regulations, standards and safety precautions must be adhered to when installing and operating the Sensor. The Sensor must be protected against mechanical influences. Install the device such that its installation position cannot be inadvertently changed. The wenglor mounting system is recommended for installing the Sensor. Additionally a suiting reflector or reflex foil has to be mounted.

6. Initial Start-Up

6.1. Initial Start-Up

Connect the Sensor to supply power (18 to 30 V DC). The display view appears.

The Sensor is ready for operation after 2 seconds. The following table provides an overview of typical, additional deviations during the warm-up phase.

Time (min.)	0	1	2	5	10	15
Deviation (mm)	±10	±7	±6	±2	±1	0

Switch to the configuration menu by pressing any key.

Note:

If no settings are adjusted in the configuration menu for a period of 30 s, the Sensor is automatically returned to the read-out view. The Sensor accesses the last used menu view when a key is once again activated.

If a setting is adjusted, it becomes active when the configuration menu is exited.

The keys are used for navigation, and for configuring settings.

Important: Do not use any sharp objects to press the keys when configuring settings, because they might otherwise be damaged.

- ▲ Navigation up.
- ▼ Navigation down.
- ◀ Acknowledge the selected menu item (arrow points towards the display).
- ▶ Accept the selected setting, exit the menu (arrow points away from the display).

6.2. Default Settings

		X1TA100QXT3	X1TA101MHxxx
Pin Function		A1: Switching output	A1: Switching output
			A2*: Switching output
		A3: Switching output	A3: Error output
Outputs	Teach Mode	Object	Object
	Switching threshold	1000 mm	1000 mm
	Hysteresis	20 mm	20 mm
	Window Size	50 mm	50 mm
	PNP/NPN	PNP	PNP
	NO/NC	NO	NO
	ON Delay	0 ms	0 ms
	OFF Delay	0 ms	0 ms
Error Output	Impulse	0 ms	0 ms
	PNP/NPN	PNP	PNP
A3 Input	NO/NC	NC	NO
	invers		
Analog	U/I	U	U
	0 V	200 mm	200 mm
	10 V	10200 mm	100200 mm
Offset	Specification Offset	0 mm	0 mm
Measure Rate		100 Hz	20 Hz
Laser		On	
Run Mode	Display Mode	Distance	Distance
	Mode	Comm	Comm
Interface	Baud Rate	38400	38400
	ASCII	binary	binary
	Interval	100 ms	100 ms
	Mask	1	1
Display	Intensity	Screensaver	Screensaver
Language		German	
Password	Enable	Off	Off
	Enter	0	0

Does apply to X1TA101MHV80

7. Functional Overview

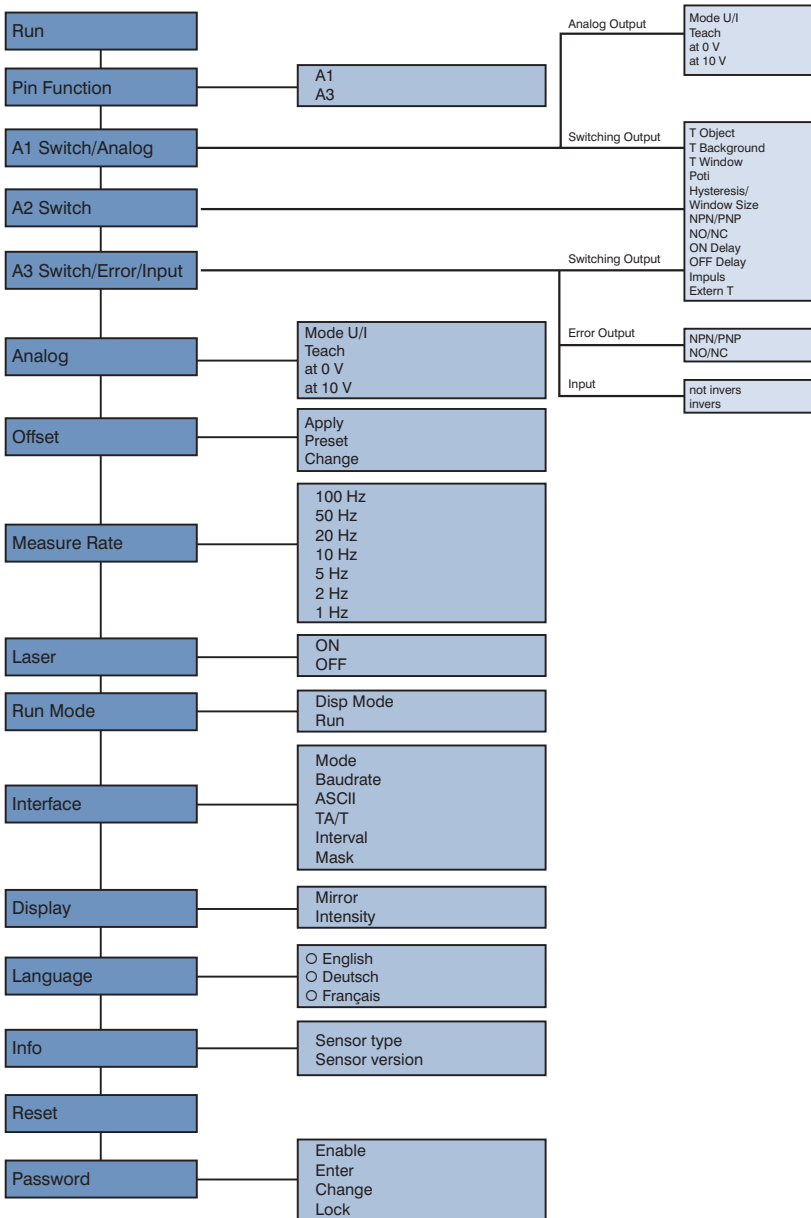

7.1. RUN







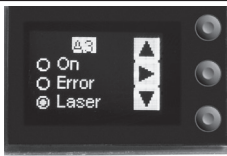

The Sensor can be switched to the display mode by pressing the ◀ key.

7.2. Pin Function

The Pin Function serves to determine the function of the pins A1 or A3. The pins can each take on different functions.

Designation	Function	Key designation		
A1	Configuration of Pin A1	▲	▶	▼
	(does apply to X1TA100QXT3) By pressing the buttons ▲ and ▼ Pin A1 can be configured as a switching output or analog output.			
A3	Configuration of Pin A3	▲	▶	▼
	By pressing the button ▲ and ▼ Pin A3 can be configured as: <input type="radio"/> a switching output <input type="radio"/> an input for application of the offset <input type="radio"/> an error output <input type="radio"/> a Teach-Input for A1 <input type="radio"/> an input for switching on/off the transmitted light. <input type="radio"/> a Teach-Input for A2 (if A2 available)			







The adjusted function of the pins is displayed figuratively in the menu “Run Mode”:

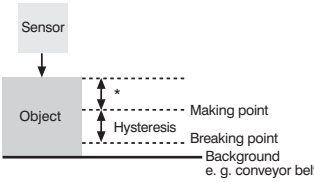

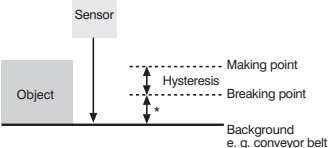

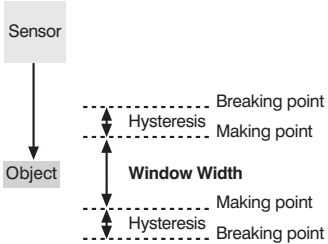



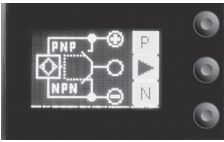

 	Teach-Input A3 for A1 or A2
  	Switch output
	Analog output
	Input
	Error output

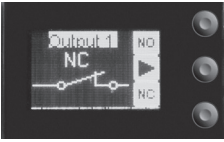
7.3. A1/A2/A3 Switch

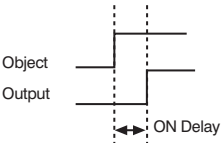
Basic settings for the individual switching outputs are selected in the A1/A2/A3 Switch menu.

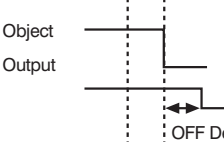
Designation	Function	Key designation		
T Object	Object Teach-In	T	▶	
	<p>Distance to the object is taught in by pressing the T key:</p> <ul style="list-style-type: none"> Align the spot to the object. Briefly press the T key. → Switching distance to the object is set. If necessary, readjust the switching distance with the help of the Potentiometer menu item. <p>* X1TA: ($\frac{\text{Hysteresis}}{2}$) + 20 mm</p>			
				

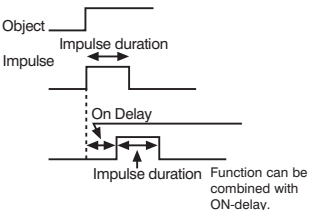
Designation	Function	Key designation		
T Background	Background-Teach-In	T	▶	
	<p>Distance to the background is taught in by pressing the T key, so that the background can be suppressed:</p> <ul style="list-style-type: none"> Align the spot to the background (e.g. conveyor belt). Briefly press the T key. <p>→ The background is suppressed.</p> <p>* X1TA: $\left(\frac{\text{Hysteresis}}{2}\right) + 20 \text{ mm}$</p>			
T Window	Teach-In a tolerance window	T	▶	
	<p>A window tolerance is taught in by pressing the T key:</p> <ul style="list-style-type: none"> Align the spot to the object. Briefly press the T key. <p>→ A tolerance window is set up around the measured distance. The window width value is adjustable (see below). The default value is 50 mm. If the measuring distance lies within the window width, the Sensor is activated.</p> <p>When the window is taught in, the lower (L) and upper (H) switching points are displayed alternately in line 3.</p>			
Poti	Readjusting the switching distance	+	▶	-
	<p>The switching distance can be readjusted by pressing the + or the – key.</p>			
Hysteresis	Adjusting switching hysteresis	+	▶	-
	<p>The hysteresis value is adjusted by pressing the + or the – key. Minimum value: depends upon the Measuring rate (see table page 5).</p>			
Window Size.	Setting the desired window width	+	▶	-
	<p>(Can only be adjusted after Teach Window). The width (10 mm...1000 mm) of the tolerance window is selected by pressing the + or the – key. The default value is 50 mm.</p>			

Designation	Function	Key designation		
NPN/PNP	Configuring the outputs	P	▶	N
	<p>The output is preset to PNP. Pressing the N key sets the output to push-pull. Pressing the N key again sets the output to NPN.</p> <p>The respective circuit diagram indicates how the output is set:</p> <p>PNP Push-pull NPN</p> 			
NO/NC	Configuring the outputs	NO	▶	NC
	<p>Outputs can be set up as normally open or normally closed by pressing the NO or the NC key. The respective circuit diagram is displayed.</p>			
ON Delay	Adjusting ON Delay	+	▶	-
	<p>ON Delay can be set to a value within a range of 0 to 10.000 ms by pressing the + or the - key.</p>			
OFF Delay	Adjusting OFF Delay	+	▶	-
	<p>Off-delay is adjusted by pressing the + or the - key. Off-delay is disabled if a impulse duration has already been selected. If this is the case, Impulse! appears at the control panel.</p>			
Impulse	Adjusting the impulse duration	+	▶	-
	<p>Impulse duration defines how long the output signal remains in the activated state. Impulse duration can be set to a value within a range of 0 to 10.000 ms by pressing the + or the - key. After the selected impulse duration has elapsed, the output signal is returned to the deactivated state.</p>			
Extern T	External Teach	▼	◀	▶
	<p>By pressing the button ▼ can be selected, if an "Object Teach-In", a "Background Teach-In", or "Teach-In of a tolerance window" is executed at the External Teach-In.</p>			

7.4. A3 Error F/A3 Input

7.4.1. A3 Error

The error output is activated if no light signal is returned to the Sensor.

Designation	Function	Key designation		
NPN/PNP	Output configuration	P	„	N



The error output is set to PNP, push-pull or NPN by pressing the P or the N key. The respective circuit diagram is displayed.

NO/NC	Output configuration	NO	„	NC
-------	----------------------	----	---	----

The error output is set up as normally open or normally closed by pressing the NO or the NC key. The respective circuit diagram is displayed.

7.4.2. A3 Input

If Pin “A3” is used as input “Emitted light disengageable” or as input “Offset”, the input can be set as an inverted or non-inverted input.

Designation	Function	Key designation		
Not invers	Usage as non-inverted input	▼	◀	▶
	Normally, the input is at supply voltage “0”. The functionality of the input is triggered upon applying a voltage > 7 V.			
invers	Usage as inverted input	▼	◀	▶
	The input is normally at a voltage of > 7 V. The functionality of the input is triggered upon applying a voltage < 7 V.			

7.5. A1 Analog/Analog

The measuring range for the analog output can be freely selected within the specified working range with rising or falling characteristic curve.

The adjusted measuring range must have a value of at least 2 % of the total measuring range.

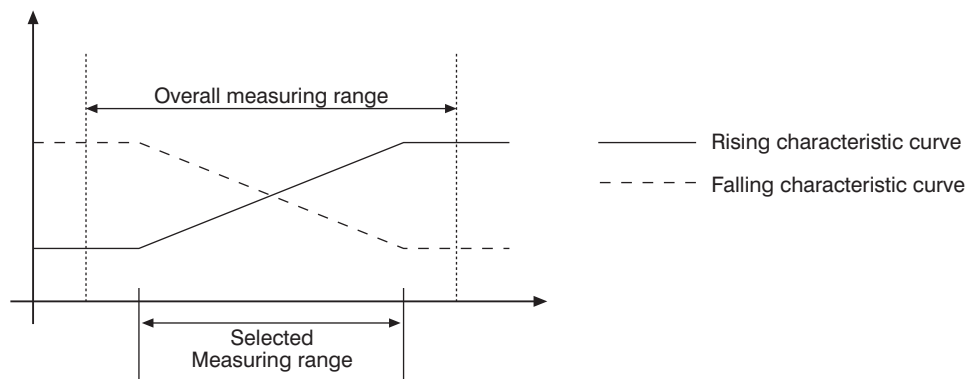

Designation	Function	Key designation		
Mode U/I	Analog output as current or voltage output	U	▶	I

The analog output can be set up as either a current or a voltage output by pressing the U or the I key. The corresponding symbol is displayed.

Teach	Teach in the distances which correspond to the upper and lower voltage values	10 V resp. 20 mA	▶	0 V resp. 4 mA
-------	---	------------------------	---	----------------------

The momentary actual distance is assigned to a voltage value of 10 V or a current value of 20 mA by pressing the 10 V or the 20 mA key.

The momentary actual distance is assigned to a voltage value of 0 V or a current value of 4 mA by pressing the 0 V or the 4 mA key.

If necessary, the assigned distances can be readjusted with the help of menu items At 0 V or at 10 V.

at 0 V	Distance at 0 V	+	▶	-
--------	-----------------	---	---	---

The distance assigned to either 0 V or 4 mA is adjusted by pressing the + or the - key.

at 10 V	Distance at 10 V	+	▶	-
---------	------------------	---	---	---



The distance assigned to either 10 V or 20 mA is adjusted by pressing the + or the - key.

7.6. Offset

The function offset serves to change the current measurement value to a certain other value. Here, the switching thresholds and the analog measurement ranges are changed as well.

The offset can take place optionally via a menu or externally via Pin A3.

Via menu

Designation	Function	Key designation		
	Accepting the value set in “Specification” as the distance.	T	◀	Z
	Teaching the offset value	T	◀	Z
	Changing the offset value that has been set in steps	▲	▶	▼

Upon pressing the button T, the offset value set in the menu option Specification is accepted as the current distance. Upon pressing the button Z, the offset function is reset and the real distance is displayed.

Upon pressing the button T, the current distance is accepted as the specification offset. Upon pressing the button Z, the offset specification value is set to 0 (the offset is activated in the menu option Apply)

By pressing the keys + or – the adjusted specification offset (menu point Preset) can be changed stepwise upwards or downwards.

*The currently set specification offset is displayed in line 3. The current distance is displayed in line 4.

Via Pin “A3”

Via the multifunctional pin A3, the offset equalization can be applied through an external trigger Sensor (corresponds to the menu **Offset** → **Apply** → **T**). Here, **A3** must be configured by means of the setting **Offset** as input (see “7.2. Pin Function” page 12).

In order to apply the Offset equalization, a voltage > 7 V should be applied at the input pin to trigger a positive flank. Here, the value set in the menu option **Preset** is accepted as the current distance.

Without Offset equalization:

In the diagram, the Sensor measures a distance of 5000 mm. The switching point is located 2000 mm distant, at 7000 mm.

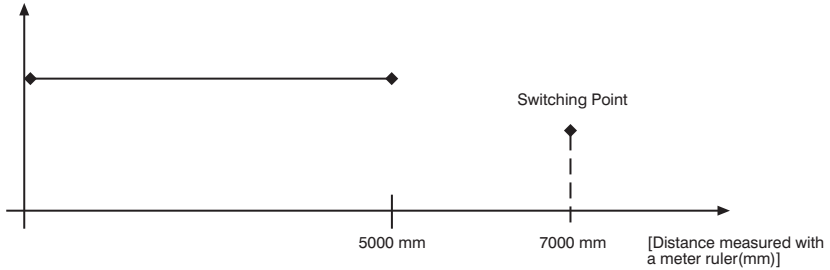

With application of the offset equalization: Specification offset: 0 mm

In the diagram, the Sensor measures a distance of 5000 mm. The switching point is located 2000 mm distant, at 7000 mm. After application of the offset equalization, from the distance 5000 mm the distance becomes 0 mm. The switching distance thus gets displaced by 7000 mm to the actual 12000 mm.

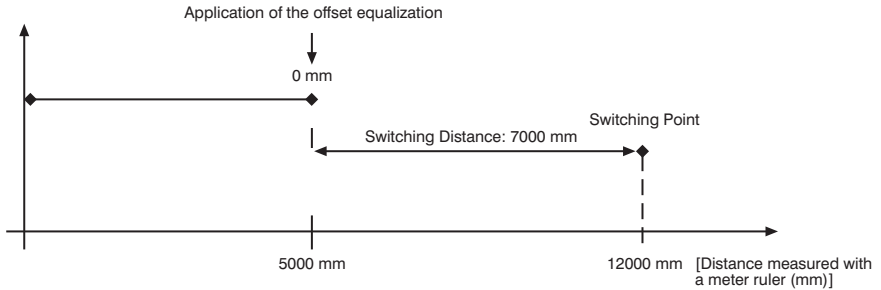

Application of the offset equalization: Specification offset: 3000 mm

In the diagram, the Sensor measures a distance of 5000 mm. The switching point is located 2000 mm distant, at 7000 mm. After application of the offset equalization, from the distance 5000 mm the distance becomes 3000 mm. The switching distance thus gets displaced by 4000 mm to the actual 9000 mm.

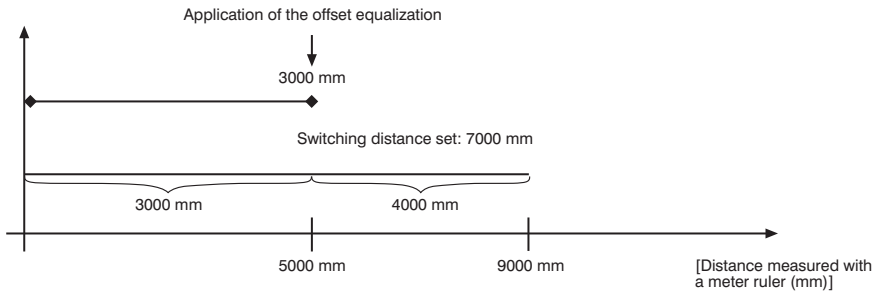

Example of application:

A X1TA101MHV80 is used in a high rack warehouse with varying ambient temperatures. To eliminate the temperature drift, a reference path of 1000 mm is specified to the Sensor as the specification offset. Through an external trigger Sensor, the specification offset is applied and given to the Sensor as the current distance. This ensures that the distance tallies with the value of the reference route with every trigger signal and thus, the varying ambient temperature has no influence on the measurement values of the Sensor.

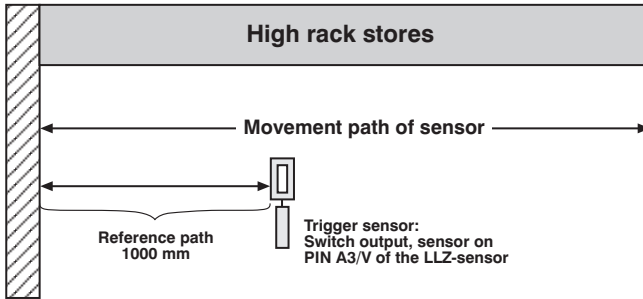

7.7. Measuring rate

Reducing the Measuring rate improves resolution and reduces minimum selectable switching hysteresis. The respective minimum and maximum values are in the table on page 5.

Designation	Function	Key designation		
100 Hz	Measuring rate value	▼	▼	▶
50 Hz				
20 Hz				
10 Hz				
5 Hz				
2 Hz				
1 Hz				

The Measuring rate which is best suited for the respective application can be selected from the pre-defined values by pressing the ▼ or the ◀ key.

7.8. Laser

Transmitted light can be either deactivated or activated with the help of the Laser menu.

Designation	Function	Key designation		
ON	Switch transmitted light on	▼	▼	▶
OFF	Switch transmitted light off			

Transmitted light is deactivated or activated by pressing the ▼ or the ◀ key.

For the products X1TA101MHT88 the laser light can be switched off via pin 5, by connecting pin 5 to 24 V. If Pin 5 has already been set as an RS-232 interface, the laser diode can be switched off with an interface command, in the menu or via the A3 input (see “7.2. Pin Function”/”7.4.2. A3 Input”).

In case of the X1TA101MHV80 the laser diode can be switched off via pin 8, by connecting pin 8 to 24 V.

7.9. Read-Out

Which data will be read out to the display as measurement results are selected in the Read-Out menu.

Designation	Function	Key designation		
DispMode	Select display characteristics	▼	◀	▶

What will appear at the monitor during display mode operation is selected by pressing the ▼ or ◀ key:

Distance: The states of the individual outputs appear at the display.

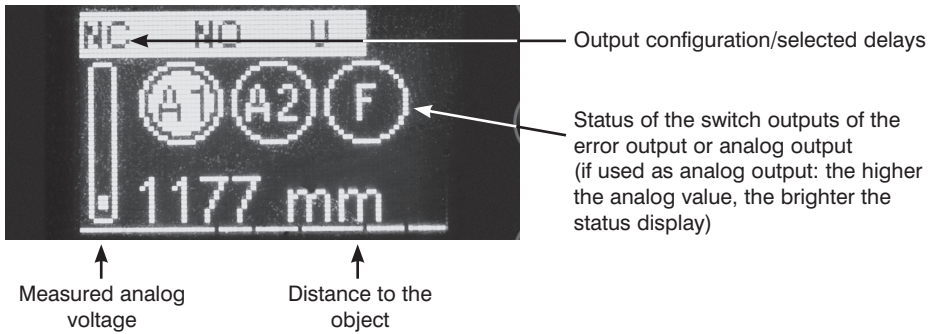

Analog: The analog output value appears at the display.

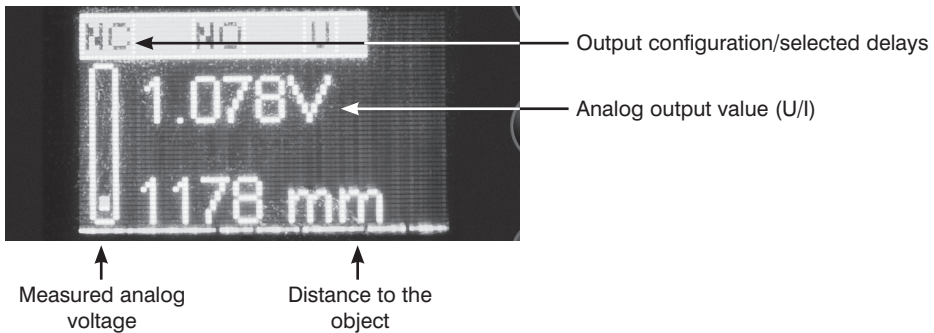

Run	Switch to the read-out view	▼	◀	▶
The device is switched to the display mode by pressing the ◀ key.				

7.10. Interface (does apply to X1TA101MHT88)

The basic settings for the interface are entered to the Interface menu.

Designation	Function	Key designation		
Mode	Basic interface settings	▼	◀	▶

One of the function types, namely **Menu**, **Comm** (default setting) or **Continuous**, is selected by pressing the ▼ or ◀ key.

Menu: The Sensor can be addressed with the help of a terminal program. A menu is generated automatically in the terminal program (see chapter 8.1).

Comm: The Sensor can be addressed by means of interface commands (see chapter 8.2).

Continuous: The Sensor reads out selected information at a defined interval.

Baud rate	Set the baud rate	▼	◀	▶
-----------	-------------------	---	---	---

The interface can be set to one of three baud rates by pressing the ▼ or ◀ key: 9600, 38.400 (default setting) or 115.200 Baud. 9600 Baud, 38.400 Baud (default setting) or 115.200 Baud.

The individual output values are explained in the following pages.

Continuous transmission: If continuous transmission is used, the values selected from the table shown below are transmitted via the interface at a defined interval.

ASCII	Selection of the output format for continuous transmission	▲	▶	▼
-------	--	---	---	---

Selection is made between the two output formats, ASCII or binary (default setting), by pressing the ▲ or the ▼ key.

TA/T	Selection of the interface protocol	▲	▶	▼
------	-------------------------------------	---	---	---

Switching between the old and new interface protocols (X1TA and XT respectively) is possible by pressing the ▲ or the ▼ key.

Interval	Selection of the transmission interval for continuous transmission	+	▶	-
----------	--	---	---	---

The length of the interval specifies how frequently data will be transmitted via the interface.
The interval can be set within a range of 10 to 10.000 ms by pressing the + or the - key.

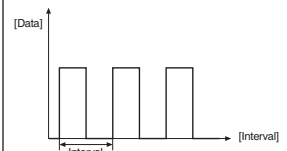

Mask	Selection of the desired output values for continuous transmission	+	▶	-
------	--	---	---	---

The selected mask specifies which information will be read out to the interface during continuous transmission.

Selection can be made from masks 1 through 31 by pressing the + or - key.

The individual values are read out consecutively to a single line. Only the values for the selected columns are read out.

1	2	3	4	5	6	7
Mask	Current distance +#####mm	Statuses of the digital outputs #####	Difference between current distance and the selected switching point (for each output) +#####mm+#####mm+#####mm	Digital read-out of the current or the voltage value (depending on the setting in the "Analog" menu) #####mV	Time stamp in ms	Transmission time in ms (packet) is displayed in line 4 of the "Mask" menu function. 9600 38400 115200
String 1	X					11,28 2,82 0,94
2		X				4,92 1,23 0,41
3	X	X				16,2 4,05 1,35
4			X			33,84 8,46 2,82
5	X		X			45,12 11,28 3,76
6		X	X			38,76 9,69 3,23
7	X	X	X			50,04 12,51 4,17
8				X		11,28 2,82 0,94
9	X			X		22,56 5,64 1,88
10		X		X		16,2 4,05 1,35
11	X	X		X		27,48 6,87 2,29
12			X	X		45,12 11,28 3,76
13	X		X	X		56,4 14,1 4,7
14		X	X	X		50,04 12,51 4,17
15	X	X	X	X		61,32 15,33 5,11
16					X	10,2 2,55 0,85
17	X				X	21,48 5,37 1,79
18		X			X	15,12 3,78 1,26
19	X	X			X	26,4 6,6 2,2
20			X		X	44,04 11,01 3,67
21	X		X		X	55,32 13,83 4,61
22		X	X		X	48,96 12,24 4,08
23	X	X	X		X	60,24 15,06 5,02
24				X	X	21,48 5,37 1,79
25	X			X	X	32,76 8,19 2,73
26		X		X	X	26,4 6,6 2,2
27	X	X		X	X	37,68 9,42 3,14
28			X	X	X	55,32 13,83 4,61
29	X		X	X	X	66,6 16,65 5,55
30		X	X	X	X	60,24 15,06 5,02
31	X	X	X	X	X	71,52 17,88 5,96

Explanation of the individual output values:

Column 2: current distance: read-out of the respective current measuring distance in mm

Column 3: statuses of the digital outputs:

0: not switched

1: switched

#	#	#	#
F	A3	A2	A1

Example: 1001 → error output and output 1 switched.

Column 4: difference between current distance and the selected switching point (for each output)

Example:

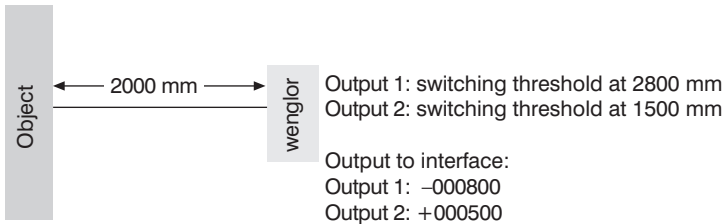

Column 5: digital read-out of the current or the voltage value in mV
(depending on the setting in the “Analog” menu)

Column 6: time stamp

Example:

Time Stamp	Measuring Distance
00001024	1805 mm
00001066	1810 mm
99999999	2068 mm
00000000	2068 mm

By outputting the time-stamp, the individual measurement distances can be assigned to a relative time without taking into consideration the processing speed of the computer.

Time stamp: $\Delta 1 \hat{=} 500 \mu\text{s}$

7.11. Display

The display can be rotated and brightness can be adjusted with the help of the Display menu.

Designation	Function	Key designation		
Rotated	The display is rotated 180°.	▼	◀	▶

The display is rotated 180° by pressing the ◀ key. The display can be returned to its original position by pressing the same key once again.

Intensity	Adjusting display intensity	▼	◀	▶
-----------	-----------------------------	---	---	---

After pressing the ▼ or ◀ key, the menu appears immediately with the selected intensity (min., normal or max). By selecting the energy saving mode the display switches off after one minute without activating a key. It switches on automatically, when activating a key again.

Note: If none of the keys are activated for a given period of time, the display is switched to the energy saving mode and the intensity is reduced. The display is returned to the selected intensity as soon as any key is activated.

7.12. Language

The desired menu language can be selected in the Language menu.

Designation	Function	Key designation		
Deutsch	Default language	▼	◀	▶
English	Menu language	▼	◀	▶
Francais	Menu language	▼	◀	▶

The desired language is selected by pressing the ▼ or ◀ key. The desired language appears in the menus as soon as it has been selected.

7.13. Info

The following information regarding the Sensor is displayed in the Info menu:

- Sensor type
- Software version
- Serial number

7.14. Reset







Sensor settings can be returned to their default values with the help of the Reset menu. Default settings are listed in section 6.2.

Designation	Function	Key designation		
Reset	Press <R> to reset	R	▶	

All of the selected Sensor settings are returned to their default values by pressing the R key.

7.15. Password

Password settings can be entered in the password menu with the following four submenus.

Designation	Function	Key designation		
Enable	Switch Password Function On or Off	▼	◀	▶
	<p>The Enable menu is accessed by pressing the ◀ key, where you can activate or deactivate the password function by selecting Off or On. After interruption of the power supply, the operation of the Sensor is locked. Immediate blockage of the operation can be done in the sub-menu "Lock".</p>			
Enter	Password Entry for Enabling the Sensor	▼	◀	▶
	<p>The Enter submenu is accessed by pressing the ◀ key, where you can enter the password in order to enable the Sensor.</p>			
	<p>The desired password is entered by means of the + or – key. Press and hold the + or – key in order to scroll quickly through the numbers. Entry is acknowledged by pressing the ▶ key. The password is set to 0 upon shipment from the factory.</p>			
Change	Change the Password	▼	◀	▶
	<p>The Change submenu is accessed by pressing the ◀ key, where you can change the password.</p>			
	<p>The desired password is selected with the + or – key, and is acknowledged with the ▶ key. Press and hold the + or – key in order to scroll quickly through the numbers.</p>			
Lock	Lock the Sensor	▼	◀	▶
	<p>The Sensor can be disabled with the help of this function, without interrupting supply power. The Sensor is disabled and switched automatically to the password entry mode after pressing the ◀ key.</p>			
	<p>A password must be entered in order to continue using the Sensor.</p>			

Notes regarding password functions:

If the password function has been activated, the password must be entered each time supply power to the Sensor is interrupted.

After pressing a key, the menu is automatically switched to the password entry mode.

The following user interface then appears:



After entering the correct password with the + or – key, the entire menu is enabled and the Sensor is ready for use.

- The password function is deactivated upon shipment from the factory.
- Passwords can be selected within a range of 0000 to 9999.

Be sure to make a note of the new password before exiting the “change password” function! If the password is forgotten, it must be overwritten with a master password. The master password can be requested by e-mail from **support@wenglor.com**.

8. More Settings and Queries via the RS-232 Interface

(does apply to X1TA101MHT88)

The interface makes use of the software handshake procedure. All settings can be configured at a PC and uploaded to the device. RS-232 interface connections RxD (5) and TxD (4) are linked to minus (pin 3, green), and can be connected to the corresponding terminals at the communication partner.

Interface configuration:

Adjustable baud rate, 8 data bits, no parity, 1 stop bit

Plug connectors included with the wenglor S232W3 plug adapter:

- 8-pin M12 plug connector for connecting the power supply and the outputs
- 8-pin M12 socket connector for direct Sensor connection
- 9-pin M12 subminiature socket connector for direct connection to the RS-232 interface at the PC, or the utilized controller

Connect the Sensor to the PC, the controller etc. via the wenglor S232W3 plug adapter. Install the plug adapter as follows:

- Disconnect the 8-conductor connector cable (S80-xx) from the Sensor.
- Connect the S232W3 plug adapter directly to the Sensor.
- Connect the 8-conductor connector cable (S80-xx) to the plug adapter.
- Connect the 9-pin subminiature socket connector at the PC to the serial interface.
- Switch the power supply on.

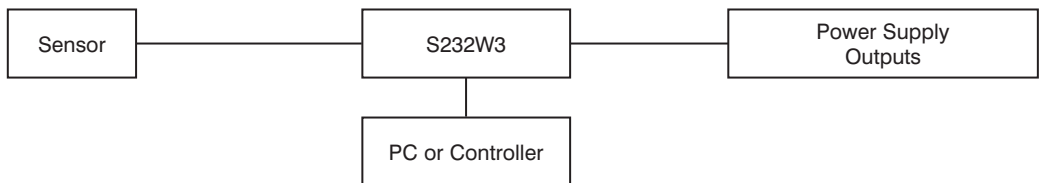

8.1. Remote Control via a Terminal Program

1. Connect the Sensor as described in chapter 8 above.

2. Set the Sensor to the Interface menu mode.

→ Select the “Interface” menu item.

→ Select “Mode”.

→ Select “Menu”.

Alternatively: Select <Comm> and with F1, select remote control via Terminal-Program.

The remote control via Terminal-Program can be ended with F4.

3. Start the terminal program at the PC,

for example start the Windows® HyperTerminal® by clicking

→ Start → Programs → Accessories → Communication → HyperTerminal.

– Settings: 38.400 Baud, 8, N, 1

– Select the utilized port (e.g. COM 1).

– Establish a connection.

The menu appears in the terminal program.

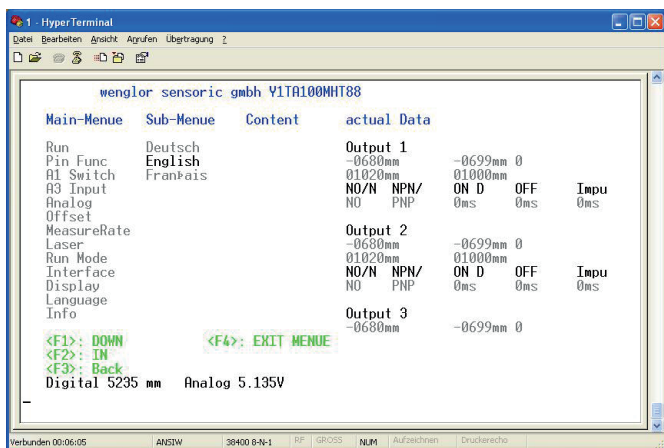

You can now navigate within the menu using the F1, F2 and F3 keys on your keyboard.

8.2. Remote Control with Interface Commands

1. Connect the Sensor as described in chapter 8 above.
2. Set the Sensor to the interface operating mode.
 - Select <Interface> from the menu.
 - Select <Mode>.
 - Select <Comm>.

The Sensor is now ready for interface communication.

The interface protocol for the X1TA can be downloaded as a PDF document from our website at www.wenglor.com under the “download” heading.

9. Maintenance Instructions

- This wenglor-Sensor is maintenance-free.
- It is advisable to clean the lens and the display, and to check the plug connections at regular intervals.
- Do not clean with solvents or cleansers which could damage the device.

10. Proper Disposal

wenglor sensoric GmbH does not accept the return of unusable or irreparable products. Respectively valid national waste disposal regulations apply to product disposal.

Discover more innovation.



For additional information about our products, please visit:
www.wenglor.com

