

Temperature Sensor

FXDD109

Part Number

weFlux² InoxSens



- FDA compliant
- Response time T90: < 2 seconds
- Robust stainless steel housing with IP69K
- Temperature measuring range: -50 ... +200° C

Technical Data

Sensor-specific data	
Sensor element	PT1000, Class B
Temperature Measurement Range	-50...200 °C
Medium	Liquids, gases
Response Time	< 2 s
Environmental conditions	
Temperature of medium	-50...200 °C
Ambient temperature	-25...80 °C
Storage temperature	-25...80 °C
Mechanical Strength	25 bar
Shock Resistance	IEC 60751
Vibration resistance	IEC 60751
Mechanical Data	
Housing Material	1.4404
Material in contact with media	1.4404
Degree of Protection	IP68/IP69K *
Connection	M12 × 1; 4-pin
Process Connection	Clamp diameter: 50,5 mm
Process Connection Length (PCL)	46 mm
Probe Length (PL)	32 mm
PT1000	●
Connection Diagram No.	140
Suitable Connection Technology No.	21

* Tested by wenglor

weFlux² Temperature Sensors ensure precise temperature measurement of liquids and gases in closed piping systems. It's easy to incorporate the standardized PT100/PT1000 resistance value into the controller. The compact housing with a diameter of just 27 mm is made of V4A stainless steel and features an easy-to-clean surface. Thanks to their rugged housing and functional design, the Temperature Sensors are FDA compliant.

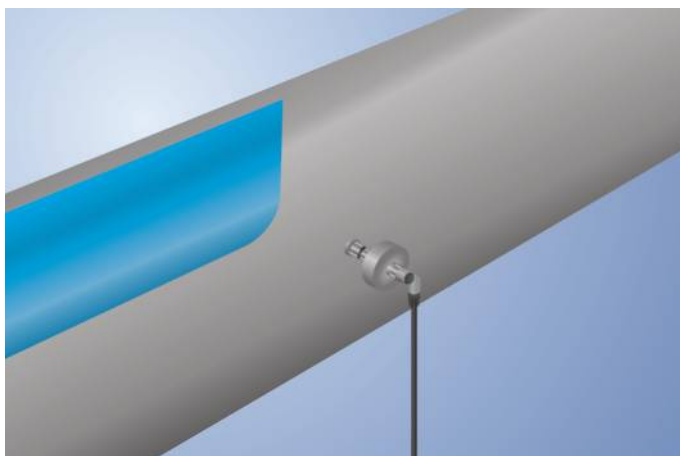

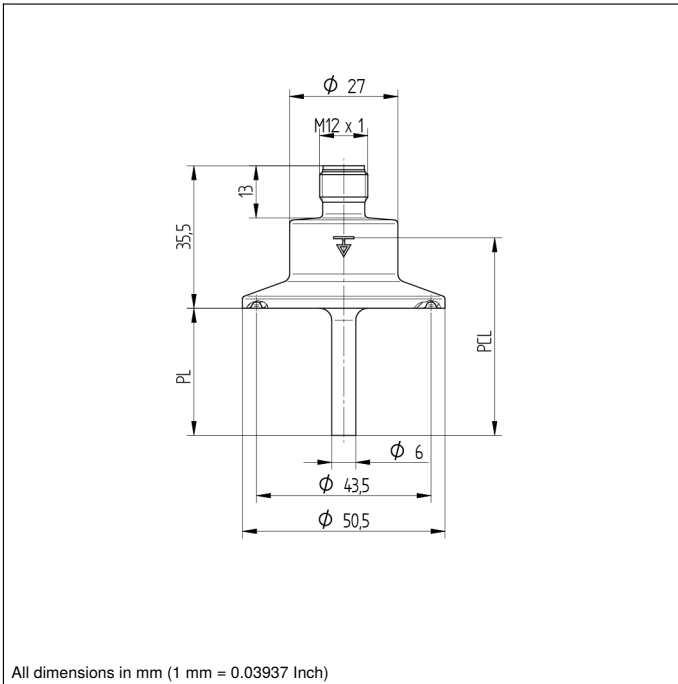

All dimensions in mm (1 mm = 0.03937 Inch)

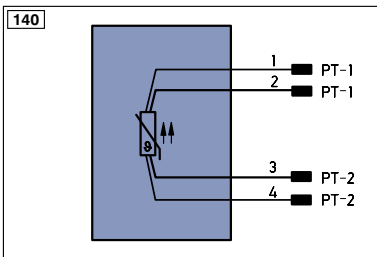

Legend

+	Supply Voltage +	PT	Platinum measuring resistor	ENa	Encoder A
-	Supply Voltage 0 V	nc	not connected	ENb	Encoder B
~	Supply Voltage (AC Voltage)	U	Test Input	AMIN	Digital output MIN
A	Switching Output (NO)	U	Test Input inverted	AMAX	Digital output MAX
Ā	Switching Output (NC)	W	Trigger Input	AOK	Digital output OK
V	Contamination/Error Output (NO)	O	Analog Output	SY In	Synchronization In
ṽ	Contamination/Error Output (NC)	O-	Ground for the Analog Output	SY OUT	Synchronization OUT
E	Input (analog or digital)	BZ	Block Discharge	OUT	Brightness output
T	Teach Input	AWV	Valve Output	M	Maintenance
Z	Time Delay (activation)	a	Valve Control Output +		
S	Shielding	b	Valve Control Output 0 V		
RxD	Interface Receive Path	SY	Synchronization		
TxD	Interface Send Path	E+	Receiver-Line		
RDY	Ready	S+	Emitter-Line		
GND	Ground	≡	Grounding		
CL	Clock	SnR	Switching Distance Reduction		
E/A	Output/Input programmable	Rx+/-	Ethernet Receive Path		
	IO-Link	Tx+/-	Ethernet Send Path		
PoE	Power over Ethernet	Bus	Interfaces-Bus A(+)/B(-)		
IN	Safety Input	La	Emitted Light disengageable		
OSSD	Safety Output	Mag	Magnet activation		
Signal	Signal Output	RES	Input confirmation		
Bl..D+/-	Ethernet Gigabit bidirect. data line (A-D)	EDM	Contactorm Monitoring		
EN0..RS422	Encoder 0-pulse 0-0 (TTL)	ENAR5422	Encoder A/Ā (TTL)		
		ENBR5422	Encoder B/B̄ (TTL)		

Wire Colors according to DIN IEC 757

BK	Black
BN	Brown
RD	Red
OG	Orange
YE	Yellow
GN	Green
BU	Blue
VT	Violet
GY	Grey
WH	White
PK	Pink
GNYE	Green/Yellow

