

ODX202

Fiber Optic Cable Sensor



Operating Instructions

Table of Content

1. Proper Use	3
2. Safety Precautions	3
3. Product Features	3
3.1. Connection Diagrams	3
3.2. Housing Dimensions	4
3.3. EC Declaration of Conformity	4
3.4. Technical Data	5
3.5. Contamination Warning	5
3.6. Contamination Output	5
3.7. Complementary Products (see catalog)	6
3.8. Control Panel	6
3.9. Mounting Instructions	6
3.9.1. Mounting to a DIN rail	6
3.9.2. Side mounting	7
3.9.3. Connecting the plastic fibre-optic cable	7
4. Adjustment	8
4.1. On-Delay and Off-Delay	8
4.2. Selecting normally closed or normally open function (NC/NO)	9
4.3. Selecting PNP/NPN/Push-Pull	9
4.4. Setting Switching Distance with the potentiometer	10
4.5. Setting Switching Distance with the Teach-In function	10
4.5.1. Normal Teach-In	10
4.5.2. Minimal Teach-In	11
4.5.3. Dynamic Teach-In (Teach-In with moving objects)	12
4.5.4. Two-point Teach-In	13
4.6. External Teach-In	13
4.7. Selecting the Run function	14
4.7.1. Normal operating mode	14
4.7.2. Selecting the Light pulse frequency	15
4.7.3. Energy saving mode	16
4.8. Test Mode	16
5. Maintenance Instructions	16
6. Proper Disposal	16

1. Proper Use

This wenglor product has to be used according to the following functional principle:

Fiber Optic Cable Sensors

Both plastic fiber optic cables and glass fiber optic cables can be connected to fiber optic cable sensors. Universal reflex sensors can be used both with and without fiber optic cables. Fiber optic cable sensors analyze the light reflected by the object. The output switches when an object reaches the selected range (detection) or when the active light beam is interrupted (operating limits). Bright objects reflect more light than dark objects, and can thus be recognized from greater distances. In barrier operation, the color of the object has no effect on the range.

2. Safety Precautions

- This operating instruction is part of the product and must be kept during its entire service life.
- Read this operating instruction carefully before using the product.
- Installation, start-up and maintenance of this product has only to be carried out by trained personnel.
- Tampering with or modifying the product is not permissible.
- Protect the product against contamination during start-up.
- Not a safety component in accordance with the EU Machinery Directive.

3. Product Features

3.1. Connection Diagrams

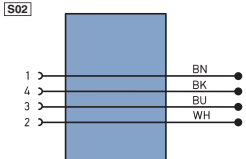
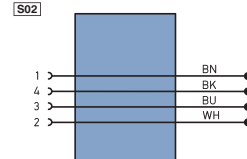
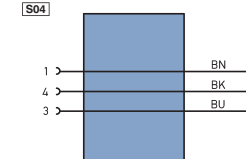
Order number		
ODX202P0007	ODX202P0107	ODX202P0008
external Teach Input	Contamination Output	–
770	771	772
<div style="border: 1px solid black; padding: 5px;"> <p>7</p> <p>S02</p>  </div>	<div style="border: 1px solid black; padding: 5px;"> <p>7</p> <p>S02</p>  </div>	<div style="border: 1px solid black; padding: 5px;"> <p>8</p> <p>S04</p>  </div>

770

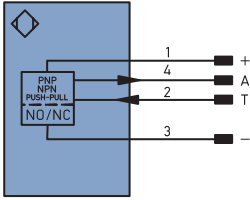

771

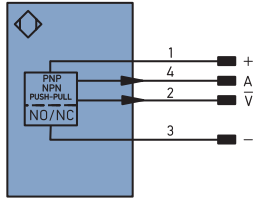

772

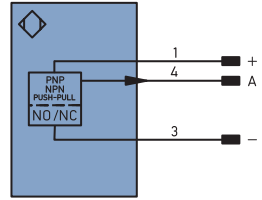

- + Supply Voltage “+”
- A Switching Output
- V Contamination Output/Error Output (NC)
- Supply Voltage “0 V”
- T Teach Input

3.2. Housing Dimensions

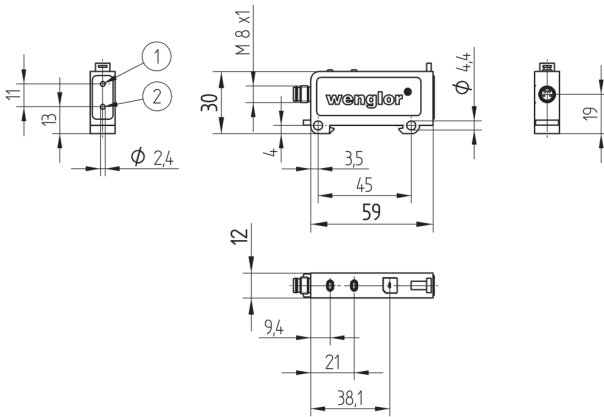

- 1 = Transmitter Diode
- 2 = Receiver Diode

3.3. EC Declaration of Conformity

The EC declaration of conformity can be found on our website at www.wenglor.com in download area.

Any additional standards which are applicable for the given application must be observed.



RoHS

3.4. Technical Data

Switching Hysteresis	< 15 %
Light Source	Red Light
Wave Length	660 nm
Service Life (Tu = 25 °C)	100000 h
max. ambient Light	10000 Lux
Supply Voltage	10...30 V DC
Current Consumption (Ub = 24 V)	< 40 mA
Switching Frequency	2 kHz
Response Time	250 μ s
ON-/OFF-Delay	0...200 ms
Temperature Drift	< 10 %
Temperature Range	-25...60 °C
Switching Output Voltage Drop	< 2,5 V
Switching Output/Switching Current	200 mA
Short Circuit Protection	yes
Reverse Polarity Protection	yes
Overload Protection	yes
Teach Mode	NT, MT, ZT, DT, TP
Adjustment	Teach-In
Housing	Plastic
Full Encapsulation	yes
Degree of Protection	IP65
Connection	M8×1
Protection Class	III
DIN-Rail mounting	35 mm

3.5. Contamination Warning

The contamination warning (included with all ODX202 types) is indicated by means of a blinking red LED (02) (with rotary switch in the Run position).

3.6. Contamination Output

The contamination output (included with ODX202P0107) functions as a normally closed contact and is switched off if the Sensor is operated within an unreliable range.

Unreliable range: ontamination, misalignment

3.7. Complementary Products (see catalog)

wenglor offers Connection Technology for field wiring.

Suiting Connection Technology No.

7

8

Glass Fiber Optic Cable

Plastic Fiber Optic Cable

3.8. Control Panel

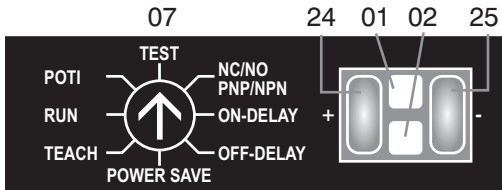

- 01 = Switching Status Indicator
- 02 = Contamination Warning
- 07 = Selector Switch
- 24 = Plus Button
- 25 = Minus Button

3.9. Mounting Instructions

All applicable electrical and mechanical regulations, standards and safety precautions must be adhered to when installing and operating the Sensor. The Sensor must be protected against mechanical influences. Install the product such that its installation position cannot be inadvertently changed.

3.9.1. Mounting to a DIN rail



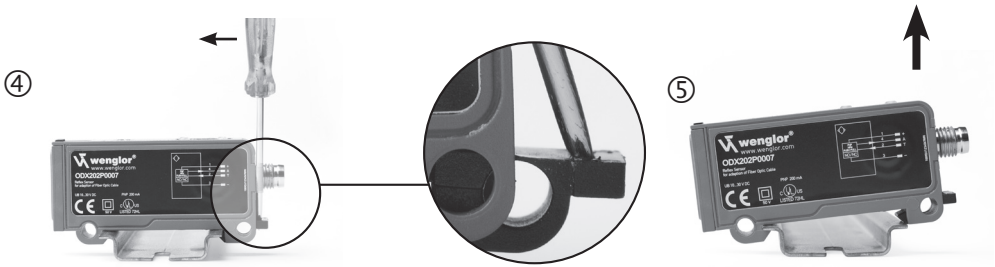

fig.1 Mounting of the Sensor to a DIN rail

3.9.2. Side mounting

Side mounting a unit: Secure the Sensor with screws (M4) through the mounting holes.



fig. 2 Side mounting of the Sensor

3.9.3. Connecting the plastic fibre-optic cable

- Please cut the plastic fibre-optic cable once before using with the SW cutting tool.
- Open the mounting slide with a screwdriver (see fig. 3-1)
- Insert the light cable into the opening provided to this end (see fig. 3-2)
- Close the mounting slide (see fig. 3-3)



fig. 3 Connecting the plastic fibre-optic cable

4. Adjustment

4.1. On-Delay and Off-Delay

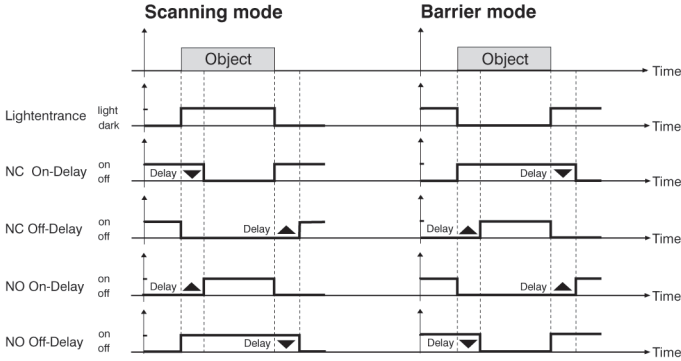

fig. 4 On-Delay and Off-Delay

Adjusting On- and Off-Delay

with rotary selector switch (07) set to On-Delay or Off-Delay

Delay	Minus Button (25)	Plus Button (24)	Gelbe Status-LED (02)
0 ms	lighted up	not lighted up	not lighted up
10 ms	not lighted up	not lighted up	1 × blinks, pause, 1 × blinks
20 ms	not lighted up	not lighted up	2 × blinks, pause, 2 × blinks
•	•	•	• • •
•	•	•	• • •
200 ms	not lighted up	lighted up	20 × blinks, pause, 20 × blinks

Adjusting On-Delay

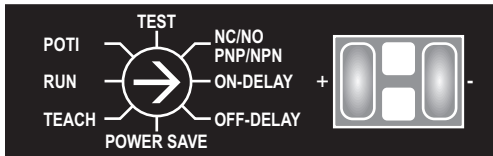

- Set rotary selector switch (07) to On-Delay
- Activate the plus button (24)
→ Delay is increased by 10 ms
- Activate the minus button (25)
→ Delay is reduced by 10 ms
- Set rotary selector switch (07) to Run

Adjusting Off-Delay

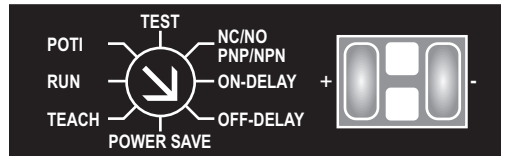

- Set rotary selector switch (07) to Off-Delay
- Activate the plus button (24)
→ Delay is increased by 10 ms
- Activate the minus button (25)
→ Delay is reduced by 10 ms
- Set rotary selector switch (07) to Run

4.2. Selecting normally closed or normally open function (NC/NO)

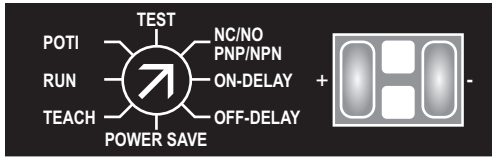

- Set rotary selector switch (07) to NC/NO
PNP/NPN
- Activate the plus button (24)
 - NC is selected (normally closed/dark switching)
 - Plus button (24) lights up
- Activate the minus button (25)
 - NO is selected (normally open/light switching)
 - Minus button (25) lights up
- Set rotary selector switch (07) to Run

4.3. Selecting PNP/NPN/Push-Pull

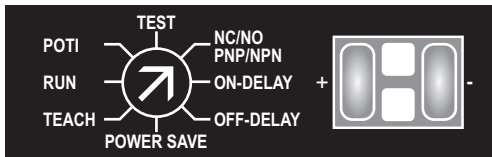

- Set rotary selector switch (07) to NC/NO
PNP/NPN
- Activate the plus button (24) for 5 seconds
 - Plus button (24) and Minus button (25) blink
- Release Plus button (24)
- Activate the plus button (24)
 - Plus Button (24) lights up
 - PNP setting
- Activate the minus button (25)
 - Minus button (25) lights up
 - NPN setting
- Activate Plus button (24) and minus button (25) at the same time
 - Plus button (24) and minus button (25) light up
 - Push-pull setting
- Set rotary selector switch (07) to Run

4.4. Setting Switching Distance with the potentiometer

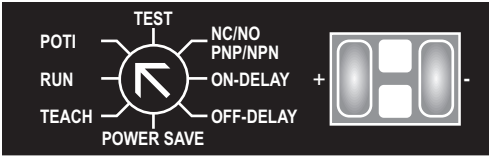

- Set rotary selector switch (07) to Poti
- Activate the plus button (24)
→ Switching Distance is increased
- Activate the minus button (25)
→ Switching Distance is reduced

The LEDs at the plus and minus buttons function like a light scale. The more brightly the respective button is illuminated, the greater the sensing distance and vice versa.

The corresponding button blinks if maximum or minimum sensing distance has been selected.

- Set rotary selector switch (07) to Run

4.5. Setting Switching Distance with the Teach-In function

The ideal Switching Distance for the object to be recognized is selected automatically with the Teach-In function:

Normal Teach-In

Minimal Teach-In

Dynamic Teach-In

Two-point Teach-In

4.5.1. Normal Teach-In

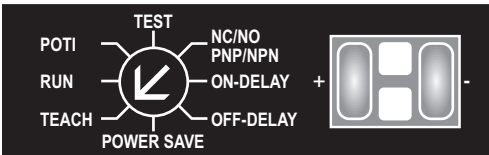

- Set rotary selector switch (70) to Teach
→ Red LED (02) lights up
- Align spot to object
- Activate the plus button (24)
→ Plus button (24) lights up
- Activate the plus button (24) again*
→ Plus button (24) is no longer illuminated
- Set rotary selector switch (07) to Run

*If a second button operation does not take place within 40 seconds, the teach-in process is aborted without saving any settings.

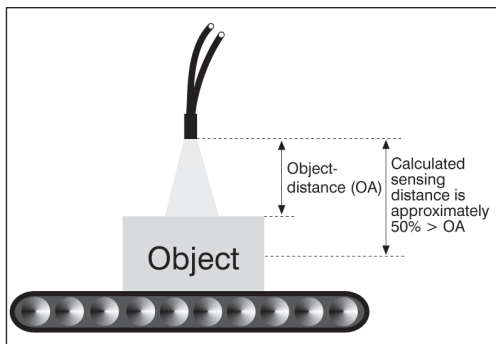

fig. 5 Scanning mode during Teach-In

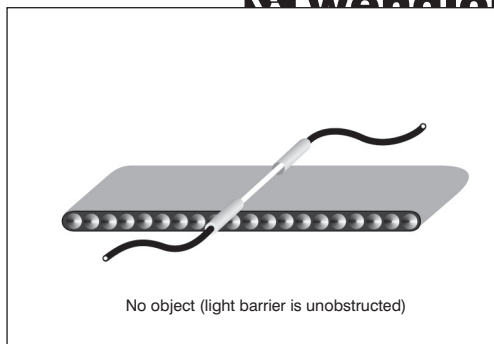

fig. 6 Barrier mode during Teach-In

4.5.2. Minimal Teach-In

- Set rotary selector switch (07) to Teach
- Align spot to object
- Activate the minus button (25)
 - Minus button (25) lights up
- Activate the minus button (25) again*
 - Minus button (25) is no longer illuminated
- Set rotary selector switch (07) to Run

* If a second button operation does not take place within 40 seconds, the teach-in process is aborted without saving any settings.

The contamination warning is out of order during minimal Teach-In.

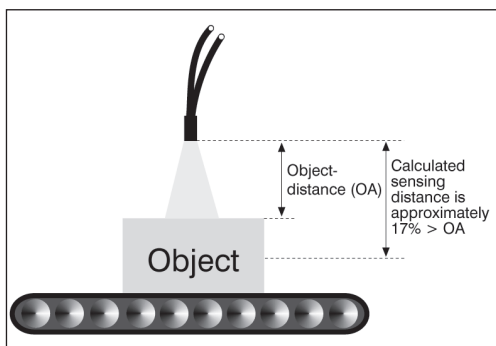

fig. 7 Scanning mode during Teach-In

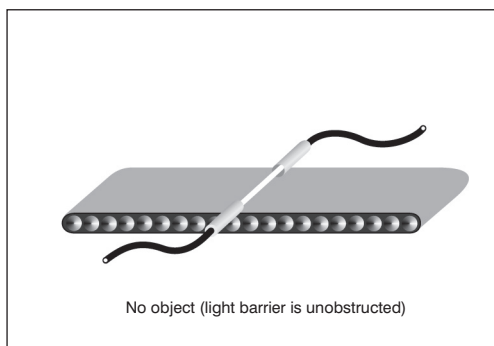

fig. 8 Barrier mode during Teach-In

4.5.3. Dynamic Teach-In (Teach-In with moving objects)

- Set rotary selector switch (07) to Teach
- Press and hold the plus button (24) until (24) blinks at the plus button (after approx. 5 sec)
→ The Sensor is now in the recording mode and acquires minimum and maximum incoming light signals
- Activate the plus button (24) again
→ The recording mode is ended
→ Plus button (24) is no longer illuminated
- Set rotary selector switch (07) to Run

The switching output is not active during Teach-In.

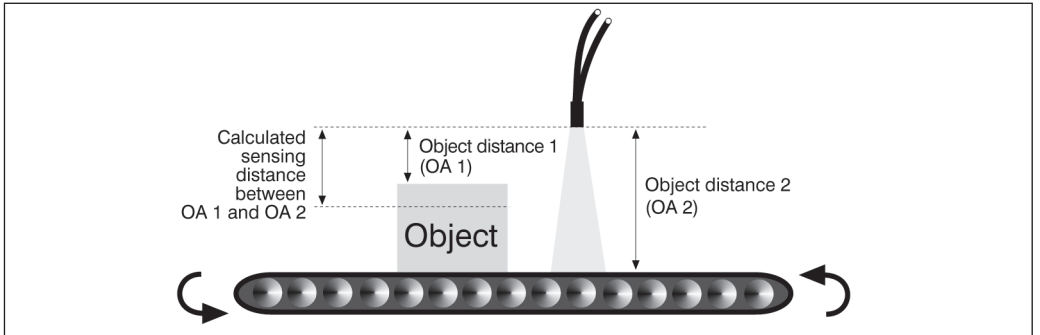

fig. 9 Dynamic Teach-In

Scanning and barrier modes

The Sensor automatically determines the ideal switching point between the minimum and maximum incoming light signals acquired during the recording mode.

If the red LED (02) blinks after completion of dynamic teach-in, the difference between the two incoming signals is too small.

4.5.4. Two-point Teach-In

- Set rotary selector switch (07) to Teach
- Align the spot to object A
- Activate the plus button (24)
 - Plus button (24) lights up
- Align the spot to object B
- Activate the minus button (25)
 - Minus button (25) lights up
- Set rotary selector switch (07) to Run

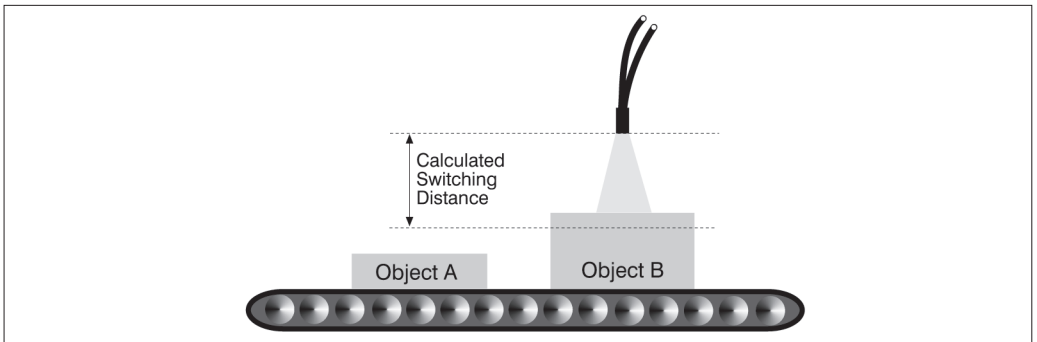

fig. 10 Two-point Teach-In

Scanning and barrier mode

The Sensor automatically determines the ideal switching point between the incoming light signals from object A and object B.

If the red LED (02) blinks after completion of two-point teach-in, the difference between the two incoming signals is too small.

4.6. External Teach-In

Initialisation

The desired teach-In process must be selected at the Sensor prior to external Teach-In.

External Normal Teach-In

(see also fig. 5 and 6)

Initialise Normal Teach-In: Set rotary selector switch to Teach, press the plus button twice, set rotary selector switch to Run)

- Set rotary selector switch (07) to Run
- Apply 10 V to 30 V to the Teach-In input (in relation to minus pole, for at least 0.3 sec)
 - Red LED (02) blinks
- Disconnect voltage from the Teach-In input
 - Teach-In process ensues
 - Red LED (02) stops blinking

External Minimal Teach-In

(see also fig. 7 and 8)

Initialise minimal Teach-In: Set rotary selector switch to Teach, press the minus button twice, set rotary selector switch to Run)

- Set rotary selector switch (07) to Run
- Apply 10 V to 30 V to the Teach-In input (in relation to minus pole, for at least 0.3 sec)
 - Red LED (02) blinks
- Disconnect voltage from the Teach-In input
 - Teach-In process ensues
 - Red LED (02) stops blinking

External Dynamic Teach-In

(see also fig. 9)

Initialise dynamic Teach-In: Set rotary selector switch to Teach, press and hold the plus button for 5 sec, release the plus button, set rotary selector switch to Run)

- Set rotary selector switch (07) to Run
- Apply 10 V to 30 V to the Teach-In input (in relation to minus pole, for the duration of recording)
 - Red LED (02) blinks
- Disconnect voltage from the Teach-In input
 - Teach-In process ensues
 - Red LED (02) stops blinking

4.7. Selecting the Run function

4.7.1. Normal operating mode

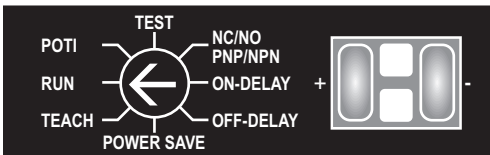

- Set rotary selector switch (07) to Run
 - Red LED (02) blinks if contamination is detected
 - Yellow LED (01) indicates switching status
 - The plus button (24) and the minus button (25) are disabled

4.7.2. Selecting the Light pulse frequency

Display of actual Light pulse frequency:

- Set rotary selector switch (07) to Power Save
 - Plus button (24) lights up: With the rotary selector switch set to Run, the light pulse frequency is 7.58 kHz.
 - Minus button (25) lights up: With the rotary selector switch set to Run, the light pulse frequency is 6.10 kHz.
 - No button lights up: With the rotary selector switch set to Run, the light pulse frequency is maximum 10 kHz.

Delete the Light pulse frequency setting:

- Set rotary selector switch (07) to Power Save
- Activate the lighted up button
 - No button is lighted up
 - Light pulse frequency is max. 10 kHz
- Set rotary selector switch (07) to Run

Select a Light pulse frequency:

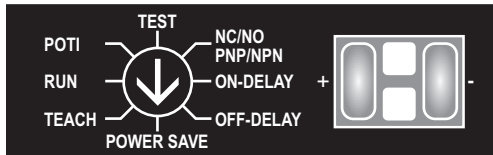

- Set rotary selector switch (07) to Power Save
- Activate the plus button (24)
 - Plus button (24) lights up
 - Light pulse frequency 7,58 kHz
- Set rotary selector switch (07) to Run
- Set rotary selector switch (07) to Power Save
- Activate the minus button (25)
 - Minus button (25) lights up
 - Light pulse frequency 6,10 kHz
- Set rotary selector switch (07) to Run

The Light pulse frequency in the Power Save Mode is unchangable 5,06 kHz.

Note: If the rotary selector switch is not set to Run within one minute after pressing the key, the light pulse frequency is not changed. The maximum switching frequency is reduced in proportion to the light pulse frequency.

4.7.3. Energy saving mode

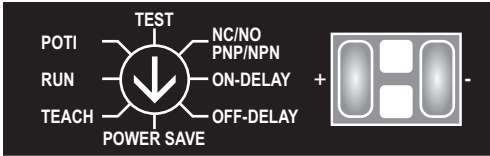

- Set rotary selector switch (07) to Power Save
 - ➔ Sensor functions same as in normal operating mode EXCEPT
 - ➔ Power consumption is reduced by approx. 40 %
 - ➔ Switching Frequency is reduced to 1 kHz

4.8. Test Mode

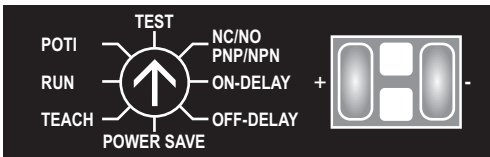

- Set rotary selector switch (07) to Test
- Activate the plus button (24)
 - ➔ The Switching Point is set to the maximal switching distance possible
- Activate the minus button (25)
 - ➔ The Switching Point is set to the minimal switching distance value possible

5. Maintenance Instructions

- This wenglor Sensor is maintenance-free.
- It is advisable to clean the lens and the display, and to check the plug connections at regular intervals.
- Do not clean with solvents or cleansers which could damage the device.

6. Proper Disposal

wenglor sensoric gmbh does not accept the return of unusable or irreparable products. Respectively valid national waste disposal regulations apply to product disposal.