

CBAS300-R4NCO-A12

Mind O≠0, I≠I≠1, S≠5, B≠8.

Operating range	0.9...4 m · 3...13½ ft
Operating voltage	10...35 V _{DC}
Current consumption	47 mA
Current load capability	200 mA
Operating temperature	-20...+55 °C · -3...+132 °F
Cycle time	13.5 ms
Ambient light immunity	100 klx
Polarity	NPN
Output function	⌋ and ⌋
IP code	IP 65
Housing material	aluminum, powder-coated
Pane material	PMMA
Operation indicator	LED green
Connection	male connector M12
Weight	262 g · 9.2 oz
Tariff code	85365019
Complies with	CE, RoHS



25 months Warranty Our products are manufactured to stringent ISO 9001 European standards to ensure that our customers only receive the best quality.

Wiring diagram

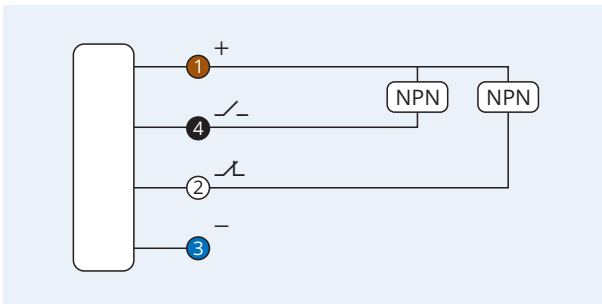

Pinout

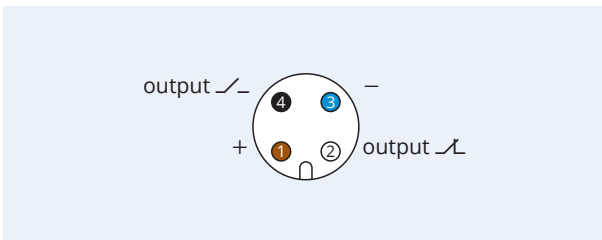

⚠ Caution! This device shall not be used if the safety of persons rely on its faultless function.

Crossed-Beam Area Sensor Receiver

Active zone: 300 mm · Range: 4 m

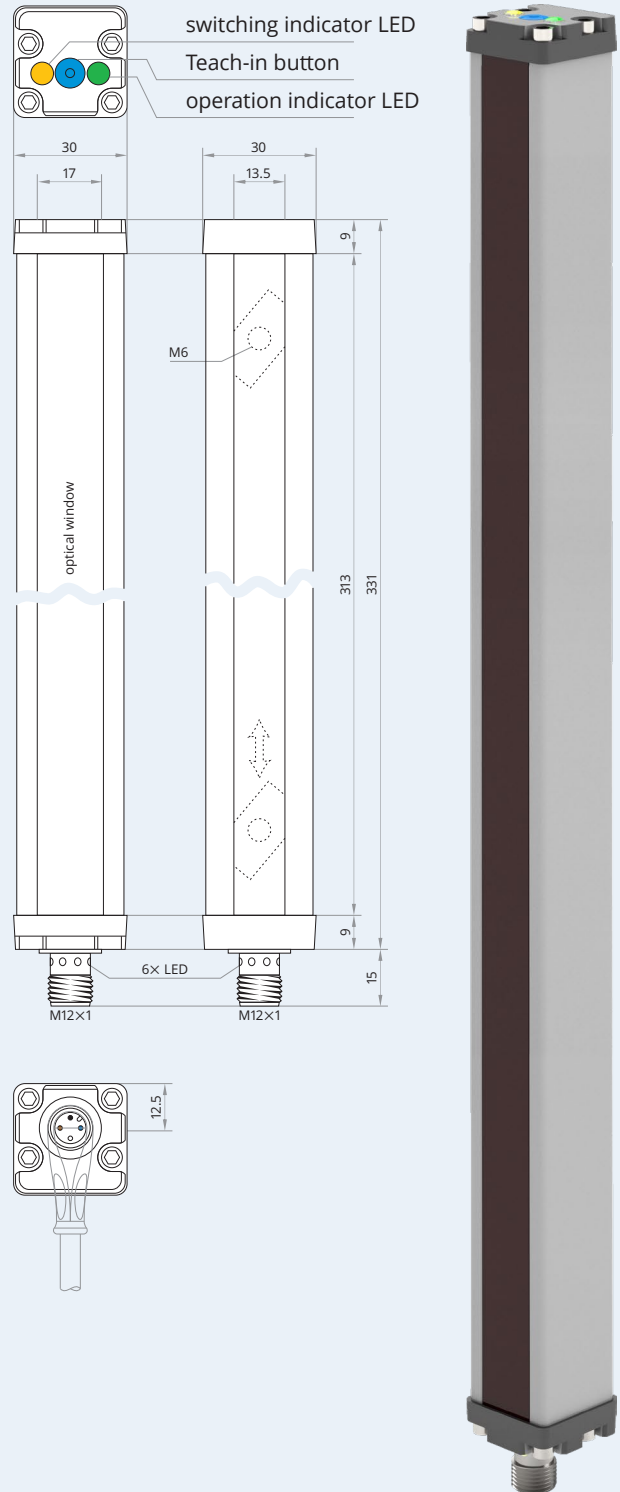

XECRO reserves the right to make minor changes without prior notification.