

## CBAS100-T4N-G2P

Mind O≠0, I≠I≠1, S≠5, B≠8.

Operating range	0.4...4 m · 1½...13½ ft
Operating voltage	10...35 V <sub>DC</sub>
Current consumption	37 mA
Operating temperature	-20...+55 °C · -3...+132 °F
Cycle time	7.5 ms
Mute input	NPN, >15 mA
IP code	IP 65
Housing material	aluminum, powder-coated
Pane material	PMMA
Quantity of beams	100
Operation indicator	LED green
Connection	PVC cable, 2 m
Weight	149 g · 5.3 oz
Tariff code	85365019
Complies with	CE, RoHS



**Warranty** Our products are manufactured to stringent ISO 9001 European standards to ensure that our customers only receive the best quality.



Wiring diagram

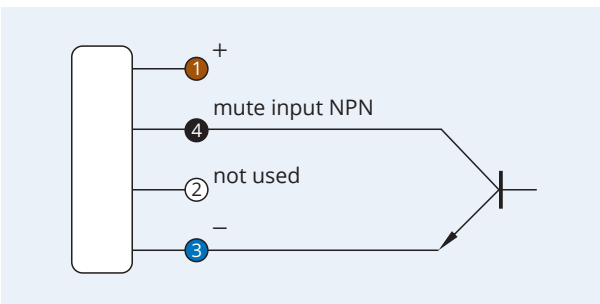

Pinout

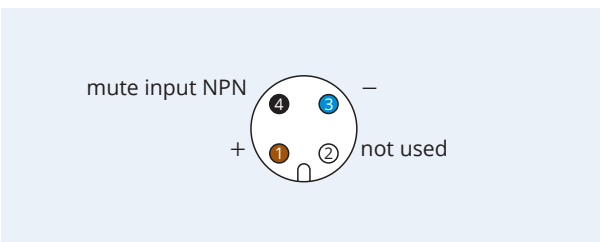

**Caution!** This device shall not be used if the safety of persons rely on its faultless function.

## Crossed-Beam Area Sensor Transmitter

Active zone: 100 mm · Range: 4 m

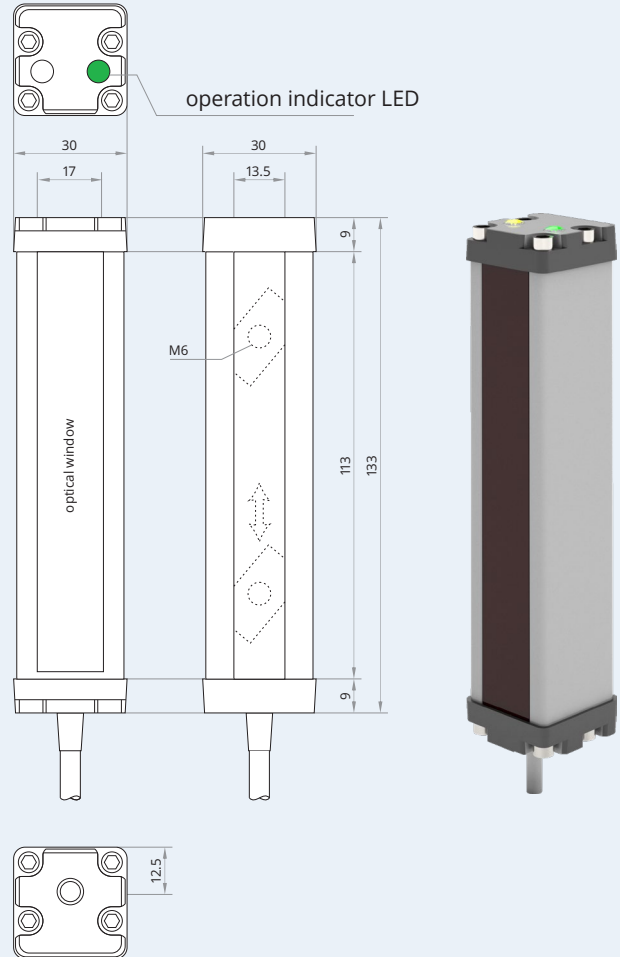

XECRO reserves the right to make minor changes without prior notification.