



Model Number

OBE2000-R2-SE2-0,2M-V31

Thru-beam sensor
with fixed cable and 4-pin, M8 connector

Features

- Ultra-small housing design
- 45° cable outlet for maximum mounting freedom under extremely tight space constraints
- Improvement in machine availability with abrasion-resistant, antistatic glass front
- Extremely large detection range in Long Range Mode
- Option of switching to high precision mode for greater switching accuracy

Product information

The nano sensor has been developed for a broad range of applications. It offers excellent durability and is exceptionally easy to install. The housing is compact and, with its 45° cable outlet, can be installed in the smallest spaces. New functional principles and functionality open up a range of new options. The abrasion-resistant lens allows long operating times close to the moving object.

Release date: 2019-10-30 01:58 Date of issue: 2019-10-30 262342_eng.xml

Dimensions

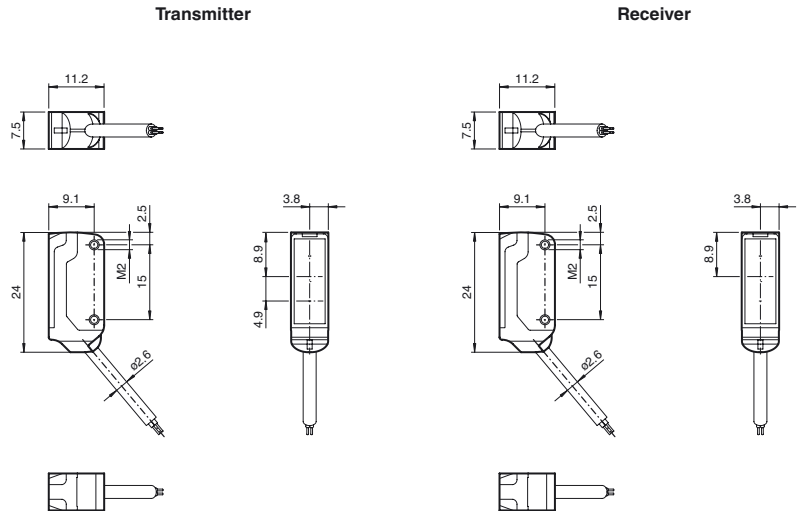

Electrical connection emitter

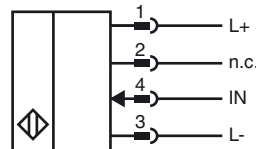

Electrical connection receiver

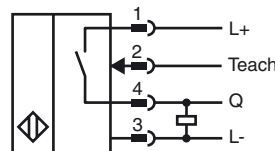

Pinout

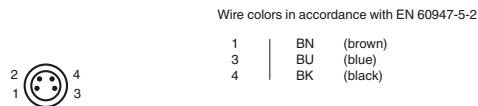

Indicators/operating means

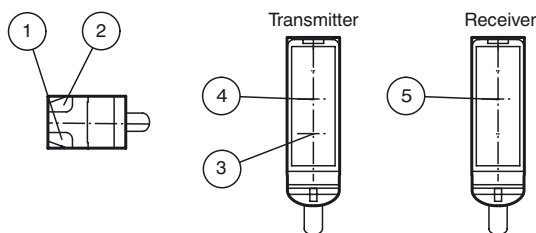

1	Operating display	green
2	Signal display	yellow
3	Emitter long range	
4	Emitter high precision	
5	Receiver	

Technical data**System components**

Emitter	OBE2000-R2-0,2M-V31
Receiver	OBE2000-R2-E2-0,2M-V31

General specifications

Effective detection range	Long range mode: 0 ... 2 m High precision mode: 0 ... 200 mm
Threshold detection range	Long range mode: 2.5 m High precision mode: 300 mm
Light source	LED
Light type	modulated visible red light , 630 nm
Angle deviation	approx. 2 °
Diameter of the light spot	Long range mode: 150 mm at a distance of 2000 mm High precision mode: 0.5 mm at a distance of 50 mm
Angle of divergence	approx. 2 °
Optical face	frontal
Ambient light limit	EN 60947-5-2 : 30000 Lux

Functional safety related parameters

MTTF _d	806 a
Mission Time (T _M)	20 a
Diagnostic Coverage (DC)	0 %

Indicators/operating means

Operation indicator	LED green, statically lit Power on , short-circuit : LED green flashing (approx. 4 Hz)
Function indicator	Receiver: LED yellow, lights up when light beam is free, flashes when falling short of the stability control ; OFF when light beam is interrupted

Electrical specifications

Operating voltage	U _B	10 ... 30 V DC , class 2
No-load supply current	I ₀	Emitter: ≤ 11 mA Receiver: ≤ 8 mA

Input

Control input	Emitter selection BK: not connected, Long Range mode BK: 0 V, High Precision Mode
Switching threshold	Teach-In input

Output

Switching type	NO contact	
Signal output	1 PNP output, short-circuit protected, reverse polarity protected, open collector	
Switching voltage	max. 30 V DC	
Switching current	max. 50 mA	
Voltage drop	U _d	≤ 1.5 V DC
Switching frequency	f	approx. 800 Hz
Response time		600 μs

Conformity

Product standard	EN 60947-5-2
------------------	--------------

Ambient conditions

Ambient temperature	-25 ... 60 °C (-13 ... 140 °F)
Storage temperature	-30 ... 70 °C (-22 ... 158 °F)

Mechanical specifications

Housing width	7.5 mm
Housing height	24 mm
Housing depth	11.2 mm
Degree of protection	IP67
Connection	200 mm fixed cable with 4-pin, M8x1 connector
Material	
Housing	PC/ABS and TPU
Optical face	glass
Cable	PUR
Installation	Fixing screws , 2 x M2 allen head screws included with delivery
Mass	approx. 20 g Per sensor
Cable length	200 mm

Approvals and certificates

UL approval	cULus Recognized, Class 2 Power Source
CCC approval	CCC approval / marking not required for products rated ≤36 V

Accessories**MH-R2-01**

Mounting aid for R2 series, Mounting bracket

MH-R2-02

Mounting aid for R2 series, Mounting bracket

MH-R2-03

Mounting aid for R2 series, Mounting bracket

MH-R2-04

Mounting aid for R2 series, Mounting bracket

V31-GM-2M-PUR

Female cordset single-ended, M8, 4-pin, PUR cable

V31-WM-2M-PUR

Female cordset single-ended, M8, 4-pin, PUR cable

Other suitable accessories can be found at www.pepperl-fuchs.com

Curves/Diagrams

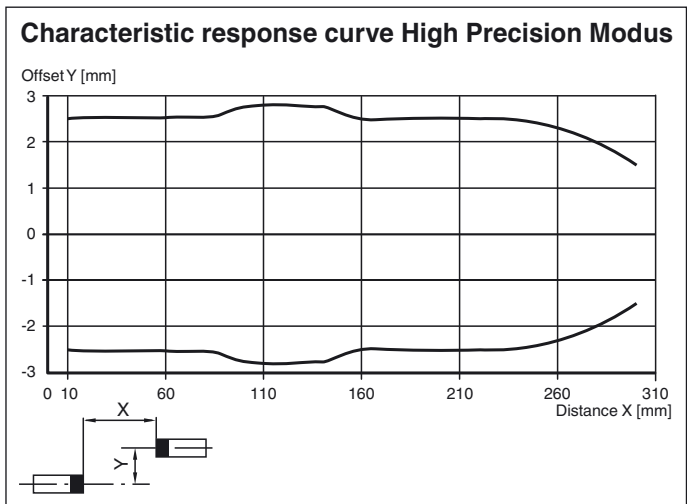
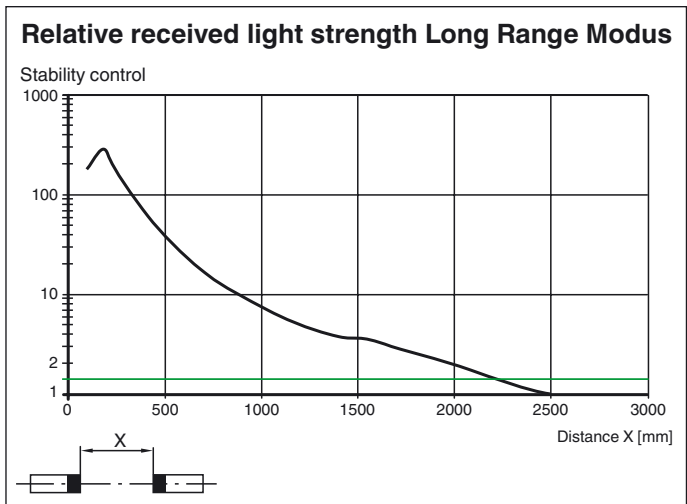
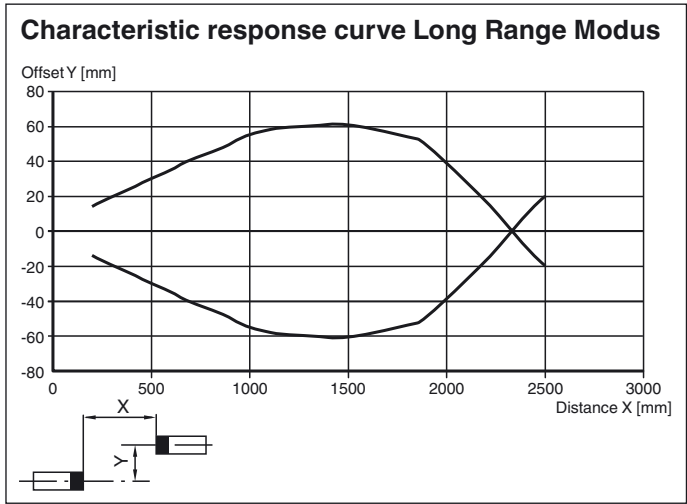

Release date: 2019-10-30 01:58 Date of issue: 2019-10-30 262342_eng.xml

Refer to "General Notes Relating to Pepperl+Fuchs Product Information".

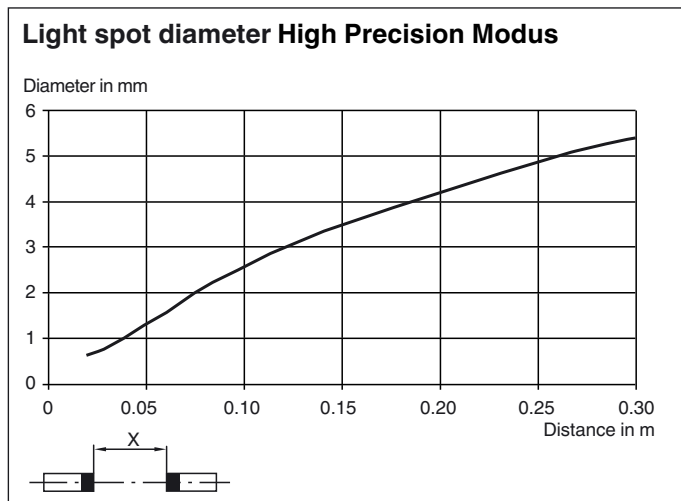
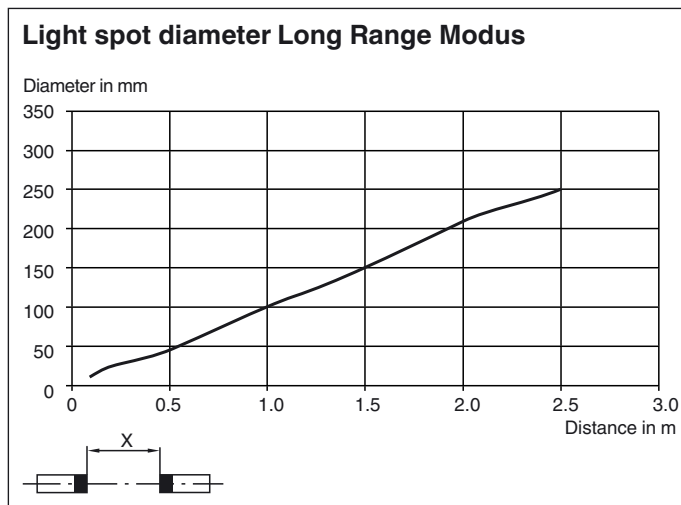
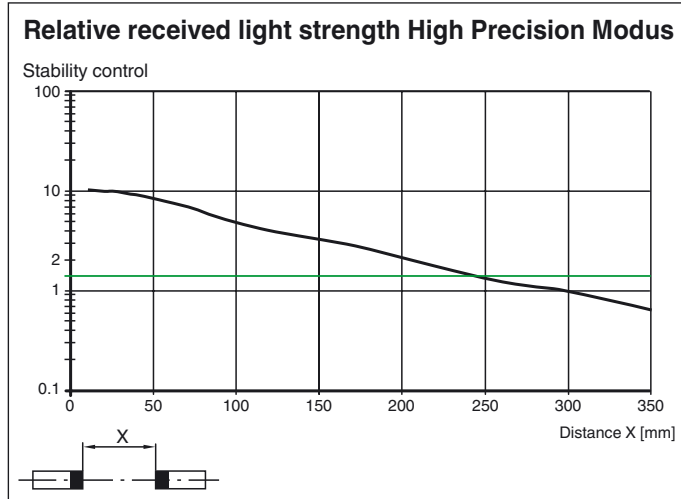

Teach-In Methods

The thru-beam sensor enables the switching points to be taught in for optimum adaptation to specific applications. This eliminates the need for additional components such as apertures.

Essentially, all Teach-in methods can be used in both "High Precision" and "High Power" operating modes.

The sensitivity of the thru-beam sensor can be adjusted using three Teach-in methods:

Position Teach

When using this Teach-in method, the following settings are made on the thru-beam sensor:

- The gain is set to an optimum value
- The signal threshold is set to a minimum



Recommended application:

Enables detection of transparent objects. This method enables extremely small differences in contrast to be detected, as well as minuscule particles in the beam path, and provides exceptional positioning accuracy.

The best results are achieved in "High Precision" mode.

1. Make sure that there are no objects in the beam path and that the sensor is connected to the power supply.
2. Connect the white cable on the receiver (WH/IN) to the blue cable (BU/0 V) on the receiver. The green and yellow LED indicators flash simultaneously at 2.5 Hz
3. Disconnect the white cable on the receiver (WH/IN) from the blue cable (BU/0 V) on the receiver. The green and yellow LED indicators flash alternately at 2.5 Hz
4. The end of the Teach-in process is indicated when the green LED indicator lights up solid and yellow LED blinks.

Two-Point Teach-In

When using this Teach-in method, the following settings are made on the thru-beam sensor:

- The gain is set to an optimum value
- The signal threshold is set in the center between the two taught signal values

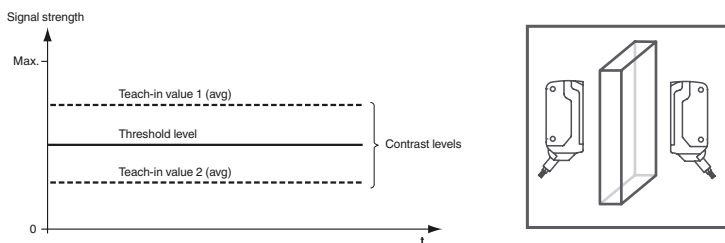

Recommended application:

Enables detection of transparent objects.

The best results are achieved in "High Precision" mode.

1. Make sure that there are no objects in the beam path and that the sensor is connected to the power supply.
2. Connect the white cable on the receiver (WH/IN) to the blue cable (BU/0 V) on the receiver. The green and yellow LED indicators flash simultaneously at 2.5 Hz
3. Position the object in the beam path.
4. Disconnect the white cable on the receiver (WH/IN) from the blue cable (BU/0 V) on the receiver. The green and yellow LED indicators flash alternately at 2.5 Hz
5. The end of the Teach-in process is indicated when the green LED indicator lights up solid.

Maximum Teach-In

When using this Teach-in method, the following settings are made on the thru-beam sensor:

- The gain is set to a maximum
- The signal threshold is set to a minimum

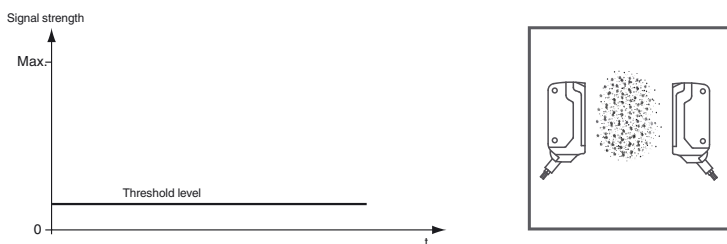

Recommended application:

Enables an object to be detected with a high excess gain. This can be useful if there is severe environmental contamination or to achieve long operating times.

The best results are achieved in "High Precision" mode.

1. Make sure that there are no objects in the beam path and that the sensor is connected to the power supply.
2. Cover the receiver or transmitter.
3. Connect the white cable on the receiver (WH/IN) to the blue cable (BU/0 V) on the receiver. The green and yellow LED indicators flash simultaneously at 2.5 Hz
4. Disconnect the white cable on the receiver (WH/IN) from the blue cable (BU/0 V) on the receiver. The green and yellow LED indicators flash alternately at 2.5 Hz
5. The end of the Teach-in process is indicated when the green LED indicator lights up solid.

Release date: 2019-10-30 01:58 Date of issue: 2019-10-30 262342_eng.xml

Refer to "General Notes Relating to Pepperl+Fuchs Product Information".