



Model Number

OBE500-R2F-SE0-L

Laser thru-beam sensor
with 2 m fixed cable

Features

- Very flat design for direct mounting without mounting bracket
- DuraBeam Laser Sensors - durable and employable like an LED
- TEACH-IN
- Detection of partially transparent objects by teach-in
- Detection of small parts or flat objects from 0.25 mm

Dimensions

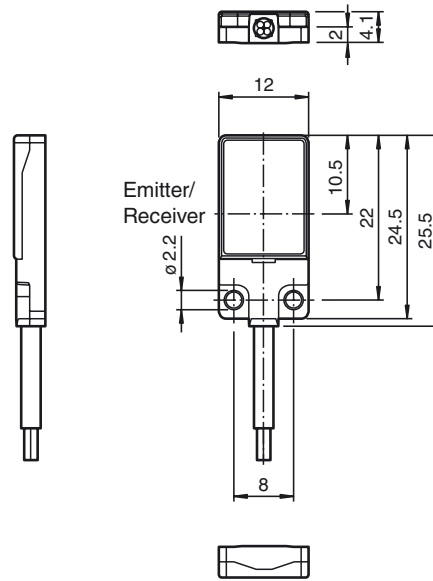

Electrical connection

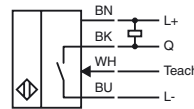
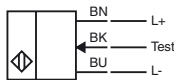

Release date: 2019-10-29 09:43 Date of issue: 2019-10-29 280472_eng.xml

Refer to "General Notes Relating to Pepperl+Fuchs Product Information".

Technical data**System components**

Emitter	OBE500-R2F-S-L
Receiver	OBE500-R2F-E0-L

General specifications

Effective detection range 0 ... 500 mm

Threshold detection range 700 mm

Light source LASER LIGHT

Light type modulated visible red light , 680 nm

Laser nominal ratings

Note LASER LIGHT , DO NOT STARE INTO BEAM

Laser class 1

Wave length 680 nm

Beam divergence > 5 mrad

Pulse length approx. 3 µs

Repetition rate approx. 16.6 kHz

max. pulse energy 8 nJ

Angle deviation approx. 0.5 °

Object size typ. starts from 0.5 mm ; typ. from 0.25 mm (after teach-in)

Diameter of the light spot approx. 4 mm at a distance of 500 mm

Angle of divergence approx. 1 °

Optical face frontal

Ambient light limit EN 60947-5-2 : 25000 Lux

Functional safety related parameters

MTTF_d 806 a

Mission Time (T_M) 20 a

Diagnostic Coverage (DC) 0 %

Indicators/operating means

Operation indicator LED green, statically lit Power on , short-circuit : LED green flashing (approx. 4 Hz)

Function indicator Receiver: LED yellow, lights up when light beam is free, flashes when falling short of the stability control ; OFF when light beam is interrupted

Electrical specifications

Operating voltage U_B 12 ... 24 V

No-load supply current I₀ Emitter: ≤ 10 mA
Receiver: ≤ 8 mA

Protection class III

Input

Test input Test of switching function at 0 V

Switching threshold Teach-In input

Output

Switching type NO contact / dark on

Signal output 1 NPN output, short-circuit protected, reverse polarity protected, open collector

Switching voltage max. 30 V DC

Switching current max. 50 mA , resistive load

Voltage drop U_d ≤ 1.5 V DC

Switching frequency f approx. 2 kHz

Response time 250 µs

Conformity

Product standard EN 60947-5-2

Laser safety EN 60825-1:2007

Ambient conditions

Ambient temperature -10 ... 60 °C (14 ... 140 °F)

Storage temperature -20 ... 70 °C (-4 ... 158 °F)

Mechanical specifications

Housing width 12 mm

Housing height 25.5 mm

Housing depth 4.1 mm

Degree of protection IP67

Connection 2 m fixed cable

Material

Housing PC (Polycarbonate) and Stainless steel

Optical face PMMA

Cable PUR

Mass approx. 20 g Per sensor

Tightening torque, fastening screws 0.25 Nm

Cable length 2 m

Approvals and certificates

UL approval E87056 , cULus Recognized, Class 2 Power Source

CCC approval CCC approval / marking not required for products rated ≤36 V

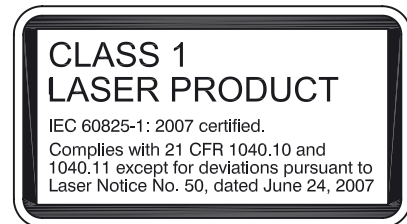
Laserlabel

Other suitable accessories can be found at www.pepperl-fuchs.com

FDA approval

IEC 60825-1:2007 Complies with 21 CFR 1040.10 and 1040.11 except for deviations pursuant to Laser Notice No. 50, dated June 24, 2007

Curves/Diagrams

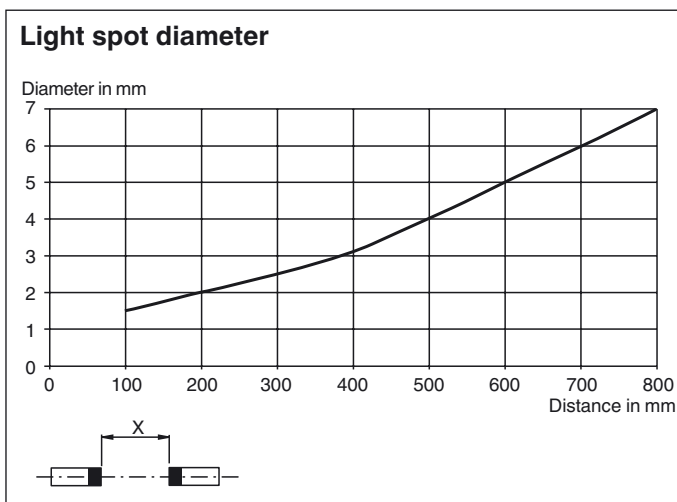
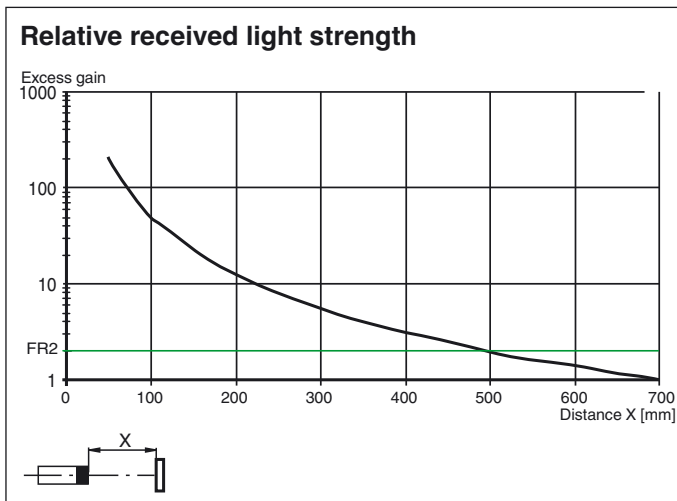
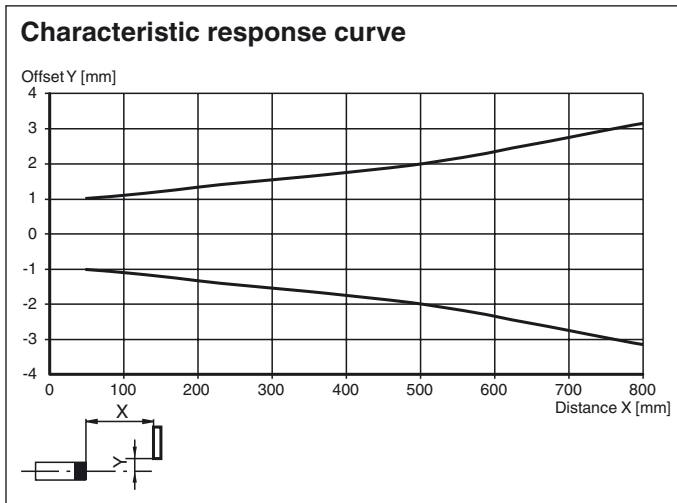

Release date: 2019-10-29 09:43 Date of issue: 2019-10-29 280472_eng.xml

Teach-In Methods

The thru-beam sensor enables the switching points to be taught in for optimum adaptation to specific applications. This eliminates the need for additional components such as apertures.

The sensitivity of the thru-beam sensor can be adjusted using three Teach-in methods:

Position Teach

When using this Teach-in method, the following settings are made on the thru-beam sensor:

- The gain is set to an optimum value
- The signal threshold is set to a minimum

Refer to "General Notes Relating to Pepperl+Fuchs Product Information".

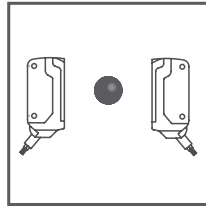
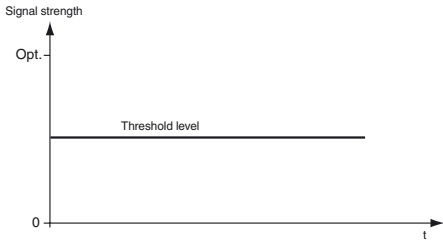

Recommended application:

This method enables minuscule particles in the beam path to be detected, and provides exceptional positioning accuracy. Make sure that there are no objects in the beam path and that the sensor is connected to the power supply.

1. Connect the white cable on the receiver (WH/IN) to the blue cable (BU/0 V) on the receiver. The green and yellow LED indicators flash simultaneously at 2.5 Hz
2. Disconnect the white cable on the receiver (WH/IN) from the blue cable (BU/0 V) on the receiver. The green and yellow LED indicators flash alternately at 2.5 Hz
3. The end of the Teach-in process is indicated when the green LED indicator lights up static and yellow LED blinks.

Two-Point Teach-In

When using this Teach-in method, the following settings are made on the thru-beam sensor:

- The gain is set to an optimum value
- The signal threshold is set in the center between the two taught signal values

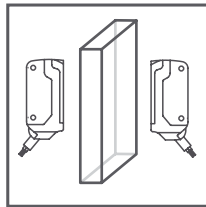
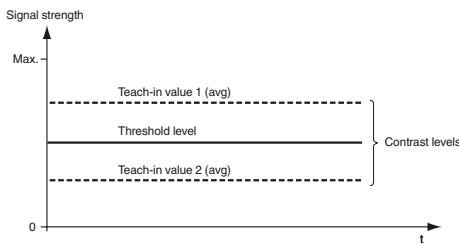

1. Make sure that there are no objects in the beam path and that the sensor is connected to the power supply.
2. Connect the white cable on the receiver (WH/IN) to the blue cable (BU/0 V) on the receiver. The green and yellow LED indicators flash simultaneously at 2.5 Hz
3. Position the object in the beam path.
4. Disconnect the white cable on the receiver (WH/IN) from the blue cable (BU/0 V) on the receiver. The green and yellow LED indicators flash alternately at 2.5 Hz
5. The end of the Teach-in process is indicated when the green LED indicator lights up static.

Maximum Teach-In

When using this Teach-in method, the following settings are made on the thru-beam sensor:

- The gain is set to a maximum
- The signal threshold is set to a minimum

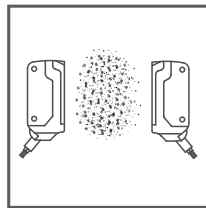
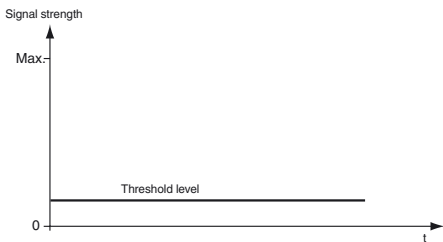

Recommended application:

Enables an object to be detected with a high excess gain. This can be useful if there is severe environmental contamination or to achieve long operating times.

Make sure that there are no objects in the beam path and that the sensor is connected to the power supply.

6. Cover the receiver or transmitter.
7. Connect the white cable on the receiver (WH/IN) to the blue cable (BU/0 V) on the receiver. The green and yellow LED indicators flash simultaneously at 2.5 Hz
8. Disconnect the white cable on the receiver (WH/IN) from the blue cable (BU/0 V) on the receiver. The green and yellow LED indicators flash alternately at 2.5 Hz
9. The end of the Teach-in process is indicated when the green LED indicator lights up static.

Laser notice laser class 1

- The irradiation can lead to irritation especially in a dark environment. Do not point at people!
- Maintenance and repairs should only be carried out by authorized service personnel!
- Attach the device so that the warning is clearly visible and readable.
- The warning accompanies the device and should be attached in immediate proximity to the device.
- Caution – Use of controls or adjustments or performance of procedures other than those specified herein may result in hazardous radiation exposure.

Release date: 2019-10-29 09:43 Date of issue: 2019-10-29 280472_eng.xml