



**Model Number**

**OBE1500-R3F-SE2-L**

Laser thru-beam sensor  
with 2 m fixed cable

**Features**

- Very flat design for direct mounting without mounting bracket
- DuraBeam Laser Sensors - durable and employable like an LED
- High detection ranges achievable
- TEACH-IN
- Detection of small parts or flat objects from 0.3 mm

**Dimensions**

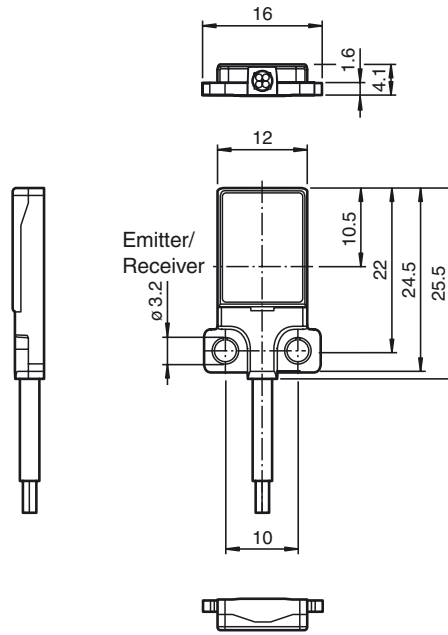

**Electrical connection**

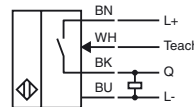
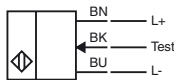

Release date: 2019-10-29 09:42 Date of issue: 2019-10-29 263496\_eng.xml

Refer to "General Notes Relating to Pepperl+Fuchs Product Information".

**Technical data****System components**

Emitter	OBE1500-R3F-S-L
Receiver	OBE1500-R3F-E2-L

**General specifications**

Effective detection range	0 ... 1500 mm
---------------------------	---------------

Threshold detection range	2100 m
---------------------------	--------

Light source	LASER LIGHT
--------------	-------------

Light type	modulated visible red light , 680 nm
------------	--------------------------------------

**Laser nominal ratings**

Note	LASER LIGHT , DO NOT STARE INTO BEAM
------	--------------------------------------

Laser class	1
-------------	---

Wave length	680 nm
-------------	--------

Beam divergence	> 5 mrad
-----------------	----------

Pulse length	approx. 3 µs
--------------	--------------

Repetition rate	approx. 16.6 kHz
-----------------	------------------

max. pulse energy	8 nJ
-------------------	------

Angle deviation	approx. 0.5 °
-----------------	---------------

Object size	typ. starts from 0.7 mm ; typ. from 0.3 mm (after teach-in)
-------------	---

Diameter of the light spot	approx. 20 mm at a distance of 1.5 m
----------------------------	--------------------------------------

Angle of divergence	approx. 1 °
---------------------	-------------

Optical face	frontal
--------------	---------

Ambient light limit	EN 60947-5-2 : 25000 Lux
---------------------	--------------------------

**Functional safety related parameters**

MTTF <sub>d</sub>	806 a
-------------------	-------

Mission Time (T <sub>M</sub> )	20 a
--------------------------------	------

Diagnostic Coverage (DC)	0 %
--------------------------	-----

**Indicators/operating means**

Operation indicator	LED green, statically lit Power on , short-circuit : LED green flashing (approx. 4 Hz)
---------------------	--

Function indicator	Receiver: LED yellow, lights up when light beam is free, flashes when falling short of the stability control ; OFF when light beam is interrupted
--------------------	---

**Electrical specifications**

Operating voltage	U <sub>B</sub> 12 ... 24 V
-------------------	----------------------------

No-load supply current	I <sub>0</sub> Emitter: ≤ 10 mA Receiver: ≤ 8 mA
------------------------	---

Protection class	III
------------------	-----

**Input**

Test input	Test of switching function at 0 V
------------	-----------------------------------

Switching threshold	Teach-In input
---------------------	----------------

**Output**

Switching type	NO contact / dark on
----------------	----------------------

Signal output	1 PNP output, short-circuit protected, reverse polarity protected, open collector
---------------	---

Switching voltage	max. 30 V DC
-------------------	--------------

Switching current	max. 50 mA , resistive load
-------------------	-----------------------------

Voltage drop	U <sub>d</sub> ≤ 1.5 V DC
--------------	---------------------------

Switching frequency	f approx. 2 kHz
---------------------	-----------------

Response time	250 µs
---------------	--------

**Conformity**

Product standard	EN 60947-5-2
------------------	--------------

Laser safety	EN 60825-1:2007
--------------	-----------------

**Ambient conditions**

Ambient temperature	-10 ... 60 °C (14 ... 140 °F)
---------------------	-------------------------------

Storage temperature	-20 ... 70 °C (-4 ... 158 °F)
---------------------	-------------------------------

**Mechanical specifications**

Housing width	16 mm
---------------	-------

Housing height	25.5 mm
----------------	---------

Housing depth	4.1 mm
---------------	--------

Degree of protection	IP67
----------------------	------

Connection	2 m fixed cable
------------	-----------------

**Material**

Housing	PC (Polycarbonate) and Stainless steel
---------	--

Optical face	PMMA
--------------	------

Cable	PUR
-------	-----

Mass	approx. 20 g Per sensor
------	-------------------------

Tightening torque, fastening screws	1 Nm
-------------------------------------	------

Cable length	2 m
--------------	-----

**Approvals and certificates**

UL approval	E87056 , cULus Recognized, Class 2 Power Source
-------------	---

CCC approval	CCC approval / marking not required for products rated ≤36 V
--------------	--

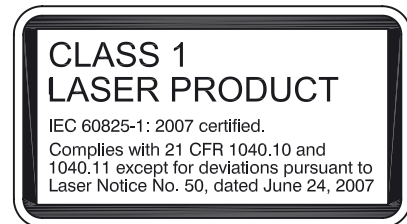
**Laserlabel**

Other suitable accessories can be found at [www.pepperl-fuchs.com](http://www.pepperl-fuchs.com)

FDA approval

IEC 60825-1:2007 Complies with 21 CFR 1040.10 and 1040.11 except for deviations pursuant to Laser Notice No. 50, dated June 24, 2007

**Curves/Diagrams**

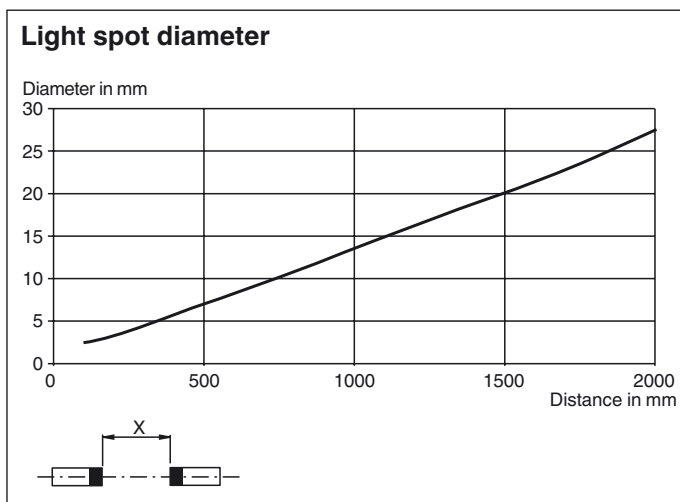
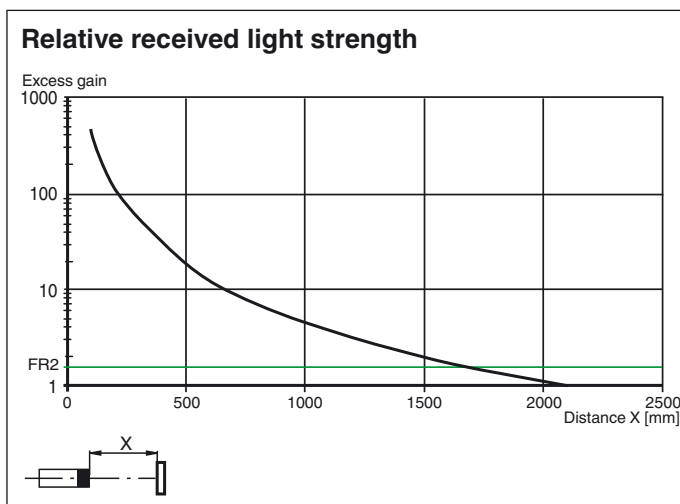
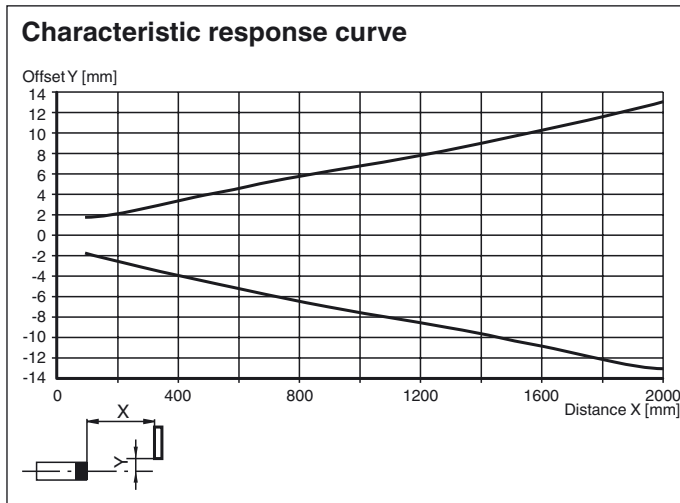

Release date: 2019-10-29 09:42 Date of issue: 2019-10-29 263496\_eng.xml

**Teach-In Methods**

The thru-beam sensor enables the switching points to be taught in for optimum adaptation to specific applications. This eliminates the need for additional components such as apertures.

The sensitivity of the thru-beam sensor can be adjusted using three Teach-in methods:

**Position Teach**

When using this Teach-in method, the following settings are made on the thru-beam sensor:

- The gain is set to an optimum value
- The signal threshold is set to a minimum

Refer to "General Notes Relating to Pepperl+Fuchs Product Information".

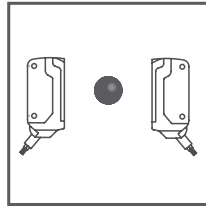
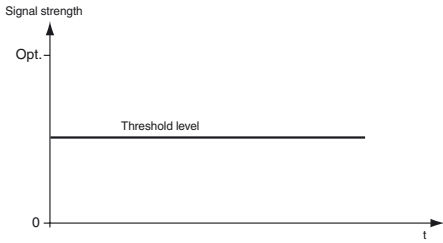

**Recommended application:**

This method enables minuscule particles in the beam path to be detected, and provides exceptional positioning accuracy. Make sure that there are no objects in the beam path and that the sensor is connected to the power supply.

1. Connect the white cable on the receiver (WH/IN) to the blue cable (BU/0 V) on the receiver. The green and yellow LED indicators flash simultaneously at 2.5 Hz
2. Disconnect the white cable on the receiver (WH/IN) from the blue cable (BU/0 V) on the receiver. The green and yellow LED indicators flash alternately at 2.5 Hz
3. The end of the Teach-in process is indicated when the green LED indicator lights up static and yellow LED blinks.

**Two-Point Teach-In**

When using this Teach-in method, the following settings are made on the thru-beam sensor:

- The gain is set to an optimum value
- The signal threshold is set in the center between the two taught signal values

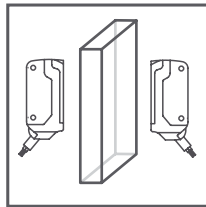
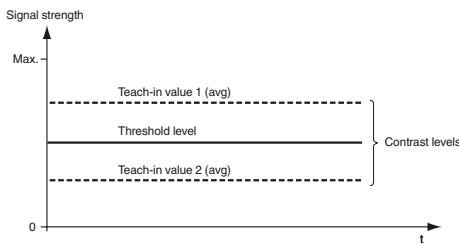

1. Make sure that there are no objects in the beam path and that the sensor is connected to the power supply.
2. Connect the white cable on the receiver (WH/IN) to the blue cable (BU/0 V) on the receiver. The green and yellow LED indicators flash simultaneously at 2.5 Hz
3. Position the object in the beam path.
4. Disconnect the white cable on the receiver (WH/IN) from the blue cable (BU/0 V) on the receiver. The green and yellow LED indicators flash alternately at 2.5 Hz
5. The end of the Teach-in process is indicated when the green LED indicator lights up static.

**Maximum Teach-In**

When using this Teach-in method, the following settings are made on the thru-beam sensor:

- The gain is set to a maximum
- The signal threshold is set to a minimum

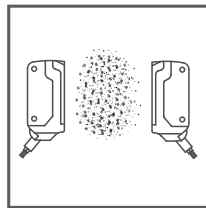
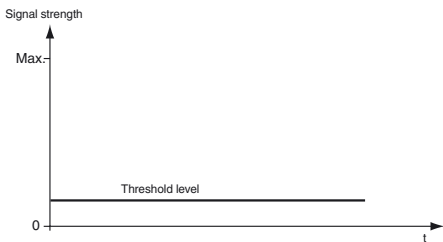

**Recommended application:**

Enables an object to be detected with a high excess gain. This can be useful if there is severe environmental contamination or to achieve long operating times.

Make sure that there are no objects in the beam path and that the sensor is connected to the power supply.

6. Cover the receiver or transmitter.
7. Connect the white cable on the receiver (WH/IN) to the blue cable (BU/0 V) on the receiver. The green and yellow LED indicators flash simultaneously at 2.5 Hz
8. Disconnect the white cable on the receiver (WH/IN) from the blue cable (BU/0 V) on the receiver. The green and yellow LED indicators flash alternately at 2.5 Hz
9. The end of the Teach-in process is indicated when the green LED indicator lights up static.

**Laser notice laser class 1**

- The irradiation can lead to irritation especially in a dark environment. Do not point at people!
- Maintenance and repairs should only be carried out by authorized service personnel!
- Attach the device so that the warning is clearly visible and readable.
- The warning accompanies the device and should be attached in immediate proximity to the device.
- Caution – Use of controls or adjustments or performance of procedures other than those specified herein may result in hazardous radiation exposure.

Release date: 2019-10-29 09:42 Date of issue: 2019-10-29 263496\_eng.xml