



Model Number

OBE25M-R200-S2EP-IO-0,3M-V31

Thru-beam sensor
with 4-pin, M12 x 1 connector

Features

- Medium design with versatile mounting options
- IO-link interface for service and process data
- Various frequencies for avoiding mutual interference (cross-talk immunity)
- Extended temperature range -40°C ... 60°C
- High degree of protection IP69K

Product information

The optical sensors in the series are the first devices to offer an end-to-end solution in a medium-sized standard design—from the thru-beam sensor through to the measuring distance sensor. As a result of this design, the sensors are able to perform practically all standard automation tasks.

The entire series enables sensors to communicate via IO-Link.

The DuraBeam laser sensors are durable and can be used in the same way as a standard sensor.

Multi Pixel Technology (MPT) ensures that the standard sensors are flexible and can be adapted to the application environment.

Dimensions

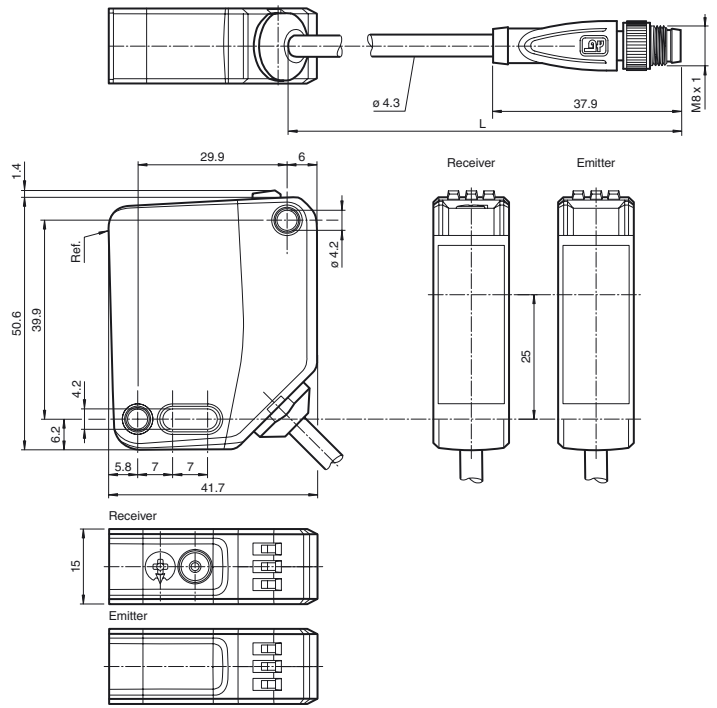

Electrical connection emitter

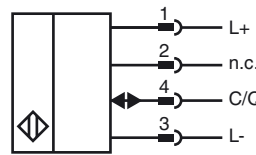

Electrical connection receiver

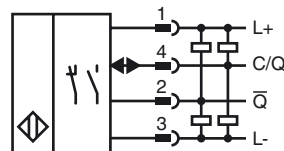

Pinout



Wire colors in accordance with EN 60947-5-2

1	BN	(brown)
2	WH	(white)
3	BU	(blue)
4	BK	(black)

Release date: 2018-05-22 17:11 Date of issue: 2019-10-31 301021_eng.xml

Indicators/operating means

Emitter

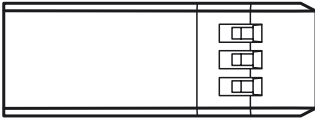

1	Operating indicator
---	---------------------

Receiver

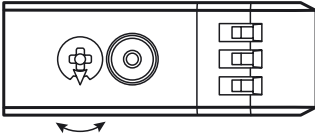

1	Sensitivity adjustment	
2	Light-on / dark-on changeover switch	
3	Operating indicator / dark on	
4	Signal indicator	
5	Operating indicator / light on	

Accessories

IO-Link-Master02-USB

IO-Link master, supply via USB port or separate power supply, LED indicators, M12 plug for sensor connection

OMH-MLV12-HWK

Mounting bracket for series MLV12 sensors

OMH-R200-01

Mounting aid for round steel \varnothing 12 mm or sheet 1.5 mm ... 3 mm

OMH-R20x-Quick-Mount

Quick mounting accessory

OMH-MLV12-HWG

Mounting bracket for series MLV12 sensors

V31-GM-2M-PUR

Female cordset single-ended, M8, 4-pin, PUR cable

V31-WM-2M-PUR

Female cordset single-ended, M8, 4-pin, PUR cable

Other suitable accessories can be found at www.pepperl-fuchs.com

Technical data	
System components	
Emitter	OBE25M-R200-S-IO-0,3M-V31
Receiver	OBE25M-R200-2EP-IO-0,3M-V31
General specifications	
Effective detection range	0 ... 25 m
Threshold detection range	33 m
Light source	LED
Light type	modulated visible red light
LED risk group labelling	exempt group
Alignment aid	LED red (in receiver lens) illuminated constantly: beam is interrupted, flashes: reaching switching point, off: sufficient stability control
Diameter of the light spot	approx. 850 mm at a distance of 25 m
Angle of divergence	approx. 2 °
Ambient light limit	EN 60947-5-2 : 40000 Lux
Functional safety related parameters	
MTTF _d	462 a
Mission Time (T _M)	20 a
Diagnostic Coverage (DC)	60 %
Indicators/operating means	
Operation indicator	LED green: constantly on - power on flashing (4Hz) - short circuit flashing with short break (1 Hz) - IO-Link mode
Function indicator	Yellow LED: Permanently lit - light path clear Permanently off - object detected Flashing (4 Hz) - insufficient operating reserve
Control elements	Receiver: light/dark switch
Control elements	Receiver: sensitivity adjustment
Electrical specifications	
Operating voltage	U _B 10 ... 30 V DC
Ripple	max. 10 %
No-load supply current	I ₀ Emitter: ≤ 15 mA Receiver: ≤ 15 mA at 24 V Operating voltage
Protection class	III
Interface	
Interface type	IO-Link (via C/Q = pin 4)
Device profile	Identification and diagnosis Smart Sensor: Receiver: type 2.4 Emitter: -
Transfer rate	COM 2 (38.4 kBaud)
IO-Link Revision	1.1
Min. cycle time	2.3 ms
Process data width	Emitter: Process data input: 0 bit Process data output: 1 bit Receiver: Process data input: 2 bit Process data output: 2 bit
SIO mode support	yes
Device ID	Emitter: 0x111401 (1119233) Receiver: 0x111301 (1118977)
Compatible master port type	A
Input	
Test input	emitter deactivation at +U _B
Output	
Switching type	The switching type of the sensor is adjustable. The default setting is: C/Q - Pin4: NPN normally open / dark-on, PNP normally closed / light-on, IO-Link /Q - Pin2: NPN normally closed / light-on, PNP normally open / dark-on
Signal output	2 push-pull (4 in 1) outputs, short-circuit protected, reverse polarity protected, overvoltage protected
Switching voltage	max. 30 V DC
Switching current	max. 100 mA , resistive load
Usage category	DC-12 and DC-13
Voltage drop	U _d ≤ 1.5 V DC
Switching frequency	f 1000 Hz
Response time	0.5 ms
Conformity	
Communication interface	IEC 61131-9
Product standard	EN 60947-5-2
Ambient conditions	

Release date: 2018-05-22 17:11 Date of issue: 2019-10-31 301021_eng.xml

Refer to "General Notes Relating to Pepperl+Fuchs Product Information".

Ambient temperature	-40 ... 60 °C (-40 ... 140 °F) , fixed cable -20 ... 60 °C (-4 ... 140 °F) , movable cable not appropriate for conveyor chains
Storage temperature	-40 ... 70 °C (-40 ... 158 °F)

Mechanical specifications

Housing width	15 mm
Housing height	50.6 mm
Housing depth	41.7 mm
Degree of protection	IP67 / IP69 / IP69K
Connection	fixed cable 300 mm with M8 x 1 male connector; 4-pin
Material	
Housing	PC (Polycarbonate)
Optical face	PMMA
Mass	Emitter: approx. 41 g receiver: approx. 41 g
Cable length	0.3 m

Approvals and certificates

UL approval	E87056 , cULus Listed , class 2 power supply , type rating 1
CCC approval	CCC approval / marking not required for products rated ≤36 V

Curves/Diagrams

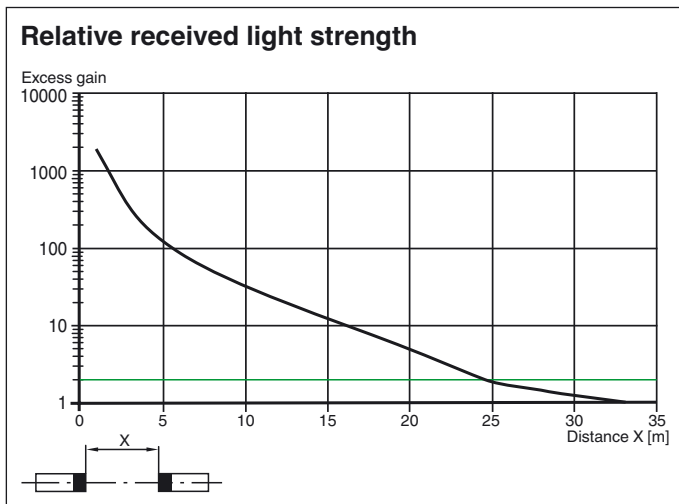
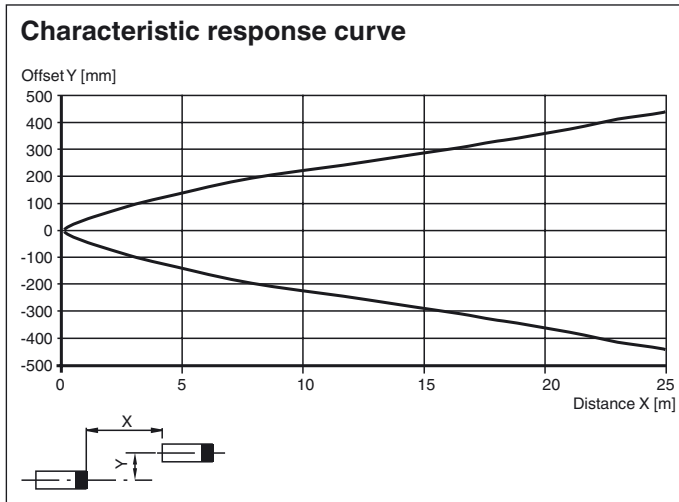

Functions and Operation

To unlock the adjustment functions turn the sensing range /sensitivity adjuster for more than 180 degrees.

Sensing Range / Sensitivity

Turn sensing range / sensitivity adjuster clockwise to increase sensing range / sensitivity.

Turn sensing range / sensitivity adjuster counter clockwise to decrease sensing range / sensitivity.

If the end of the adjustment range is reached, the signal indicator starts flashing with 8 Hz.

Light-on / Dark-on Configuration

Press the light-on / dark-on changeover switch for more than 1 second (less than 4 seconds). The light-on / dark-on mode changes and the operating indicators are activated accordingly.

Release date: 2018-05-22 17:11 Date of issue: 2019-10-31 301021_eng.xml

If you press the light-on / dark-on changeover switch for more than 4 seconds, the light-on /dark-on mode changes back to the original setting. On release of the light-on / dark-on changeover switch the current state is activated.

Restore Factory Settings

Press the light-on / dark-on changeover switch for more than 10 seconds (less than 30 seconds) until all LEDs turn off. On release of the light-on / dark-on changeover switch the signal indicator turns on. After 5 seconds the sensor resumes operation with factory default settings.

After 5 minutes of inactivity the sensing range / sensitivity adjustment is locked. In order to reactivate the sensing range / sensitivity adjustment, turn the sensing range /sensitivity adjuster for more than 180 degrees.