



Model Number

OBE500-R3F-SE2-0,2MV31-Y263494

Thru-beam sensor (pair)
with 0.2 m fixed cable and M8 plug, 4-pin

Features

- Very flat design for direct mounting without mounting bracket
- Very bright, highly visible light spot

Dimensions

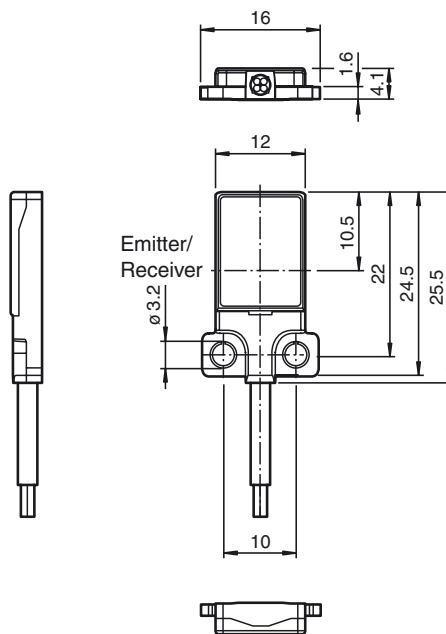

Electrical connection

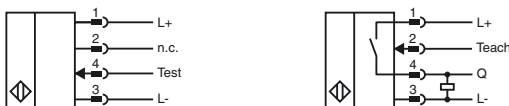

Pinout



Wire colors in accordance with EN 60947-5-2

1	BN	(brown)
2	WH	(white)
3	BU	(blue)
4	BK	(black)

Release date: 2019-10-29 09:58 Date of issue: 2019-10-29 263494_eng.xml

Refer to "General Notes Relating to Pepperl+Fuchs Product Information".

Technical data**System components**

Emitter	OBE500-R3F-S-0,2M-V31
Receiver	OBE500-R3F-E2-0,2M-V31-Y814592

General specifications

Effective detection range 0 ... 500 mm

Threshold detection range 700 mm

Light source LED

Light type modulated visible red light , 630 nm

LED risk group labelling exempt group

Angle deviation approx. 2 °

Object size typ. starts from 1.5 mm

Diameter of the light spot approx. 90 mm at a distance of 500 mm

Angle of divergence approx. 5 °

Optical face frontal

Ambient light limit EN 60947-5-2 : 25000 Lux

Functional safety related parameters

MTTF_d 806 a

Mission Time (T_M) 20 a

Diagnostic Coverage (DC) 0 %

Indicators/operating means

Operation indicator LED green, statically lit Power on , short-circuit : LED green flashing (approx. 4 Hz)

Function indicator Receiver: LED yellow, lights up when light beam is free, flashes when falling short of the stability control ; OFF when light beam is interrupted

Electrical specifications

Operating voltage U_B 10 ... 30 V DC

No-load supply current I₀ Emitter: ≤ 11 mA
Receiver: ≤ 8 mA

Protection class III

Input

Test input Test of switching function at 0 V

Switching threshold Teach-In input

Output

Switching type NO contact / dark on

Signal output 1 PNP output, short-circuit protected, reverse polarity protected, open collector

Switching voltage max. 30 V DC

Switching current max. 50 mA , resistive load

Voltage drop U_d ≤ 1.5 V DC

Switching frequency f approx. 1 kHz

Response time 500 μs

Conformity

Product standard EN 60947-5-2

Ambient conditions

Ambient temperature -25 ... 60 °C (-13 ... 140 °F)

Storage temperature -20 ... 70 °C (-4 ... 158 °F)

Mechanical specifications

Housing width 16 mm

Housing height 25.5 mm

Housing depth 4.1 mm

Degree of protection IP67

Connection 200 mm fixed cable with 4-pin, M8x1 connector

Material

Housing PC (Polycarbonate) and Stainless steel

Optical face PMMA

Cable PUR

Mass approx. 10 g Per sensor

Tightening torque, fastening screws 1 Nm

Cable length 200 mm

Approvals and certificates

UL approval E87056 , cULus Recognized, Class 2 Power Source

CCC approval CCC approval / marking not required for products rated ≤36 V

Accessories**V31-GM-2M-PUR**

Female cordset single-ended, M8, 4-pin, PUR cable

V31-WM-2M-PUR

Female cordset single-ended, M8, 4-pin, PUR cable

Other suitable accessories can be found at www.pepperl-fuchs.com

Curves/Diagrams

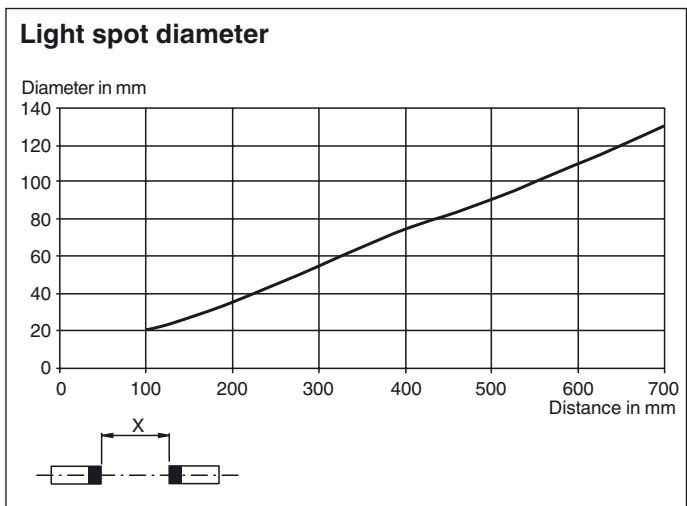
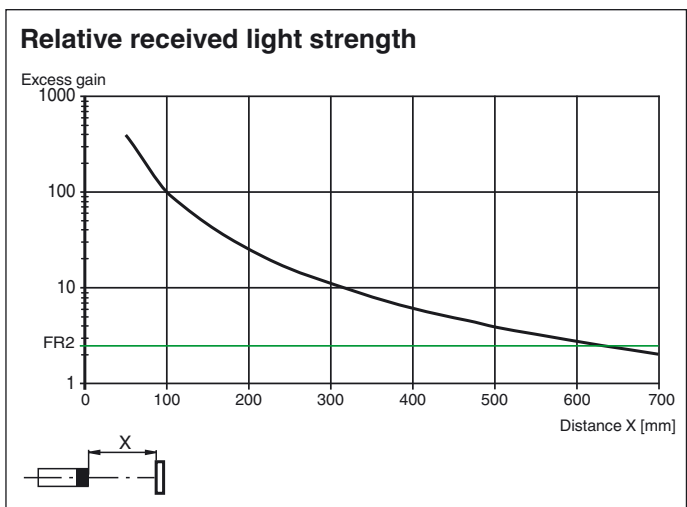
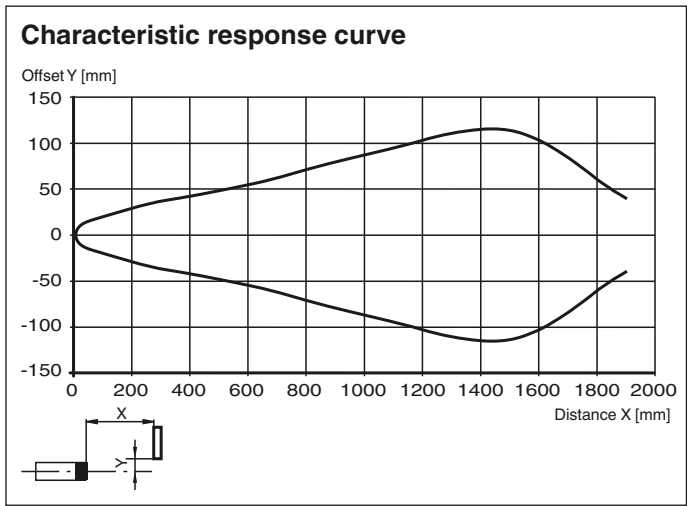

Teach-In Methods

The thru-beam sensor enables the switching points to be taught in for optimum adaptation to specific applications. This eliminates the need for additional components such as apertures.

The sensitivity of the thru-beam sensor can be adjusted using three Teach-in methods:

Position Teach

When using this Teach-in method, the following settings are made on the thru-beam sensor:

- The gain is set to an optimum value
- The signal threshold is set to a minimum

Release date: 2019-10-29 09:58 Date of issue: 2019-10-29 263494_eng.xml

Refer to "General Notes Relating to Pepperl+Fuchs Product Information".

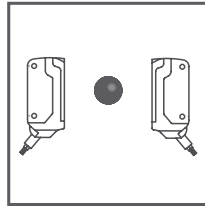
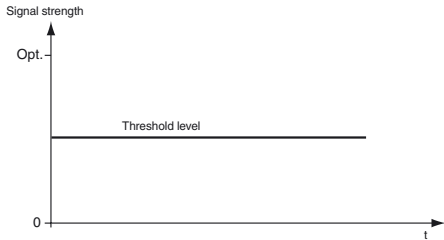

Recommended application:

This method enables minuscule particles in the beam path to be detected, and provides exceptional positioning accuracy. Make sure that there are no objects in the beam path and that the sensor is connected to the power supply.

1. Connect the white cable on the receiver (WH/IN) to the blue cable (BU/0 V) on the receiver. The green and yellow LED indicators flash simultaneously at 2.5 Hz
2. Disconnect the white cable on the receiver (WH/IN) from the blue cable (BU/0 V) on the receiver. The green and yellow LED indicators flash alternately at 2.5 Hz
3. The end of the Teach-in process is indicated when the green LED indicator lights up static and yellow LED blinks.

Two-Point Teach-In

When using this Teach-in method, the following settings are made on the thru-beam sensor:

- The gain is set to an optimum value
- The signal threshold is set in the center between the two taught signal values

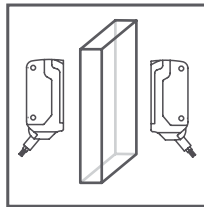
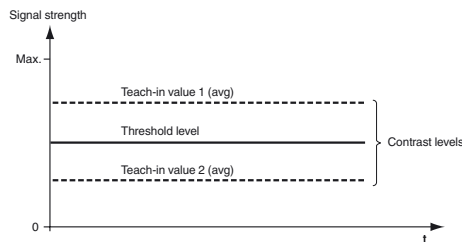

1. Make sure that there are no objects in the beam path and that the sensor is connected to the power supply.
2. Connect the white cable on the receiver (WH/IN) to the blue cable (BU/0 V) on the receiver. The green and yellow LED indicators flash simultaneously at 2.5 Hz
3. Position the object in the beam path.
4. Disconnect the white cable on the receiver (WH/IN) from the blue cable (BU/0 V) on the receiver. The green and yellow LED indicators flash alternately at 2.5 Hz
5. The end of the Teach-in process is indicated when the green LED indicator lights up static.

Maximum Teach-In

When using this Teach-in method, the following settings are made on the thru-beam sensor:

- The gain is set to a maximum
- The signal threshold is set to a minimum

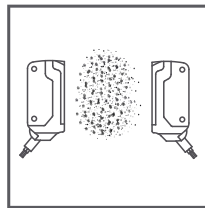
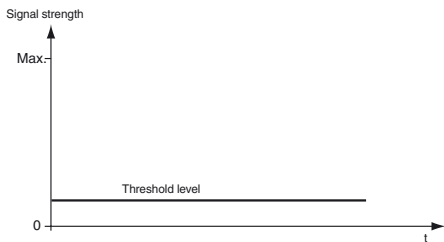

Recommended application:

Enables an object to be detected with a high excess gain. This can be useful if there is severe environmental contamination or to achieve long operating times.

Make sure that there are no objects in the beam path and that the sensor is connected to the power supply.

6. Cover the receiver or transmitter.
7. Connect the white cable on the receiver (WH/IN) to the blue cable (BU/0 V) on the receiver. The green and yellow LED indicators flash simultaneously at 2.5 Hz
8. Disconnect the white cable on the receiver (WH/IN) from the blue cable (BU/0 V) on the receiver. The green and yellow LED indicators flash alternately at 2.5 Hz
9. The end of the Teach-in process is indicated when the green LED indicator lights up static.

Release date: 2019-10-29 09:58 Date of issue: 2019-10-29 263494_eng.xml