



**Model Number**

**OBE25M-R201-S2EP-IO-0,3M-V31**

Thru-beam sensor (pair)  
with 4-pin, M12 x 1 connector

**Features**

- Medium design with versatile mounting options
- IO-link interface for service and process data
- Various frequencies for avoiding mutual interference (cross-talk immunity)
- Extended temperature range -40°C ... 60°C
- High degree of protection IP69K

**Product information**

The optical sensors in the series are the first devices to offer an end-to-end solution in a medium-sized standard design—from the thru-beam sensor through to the measuring distance sensor. As a result of this design, the sensors are able to perform practically all standard automation tasks.

The entire series enables sensors to communicate via IO-Link.

The DuraBeam laser sensors are durable and can be used in the same way as a standard sensor.

Multi Pixel Technology (MPT) ensures that the standard sensors are flexible and can be adapted to the application environment.

**Dimensions**

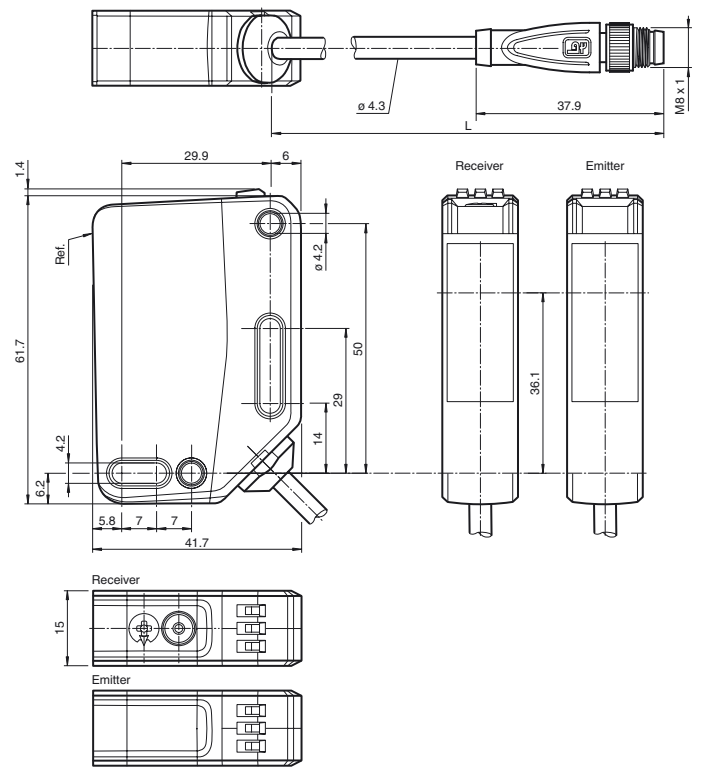

**Electrical connection emitter**

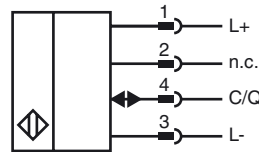

**Electrical connection receiver**

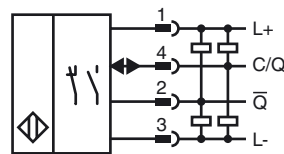

**Pinout**

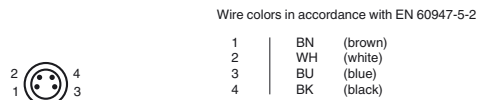

Release date: 2018-05-23 09:21 Date of issue: 2019-10-31 301106\_eng.xml

Refer to "General Notes Relating to Pepperl+Fuchs Product Information".

**Indicators/operating means**

**Emitter**

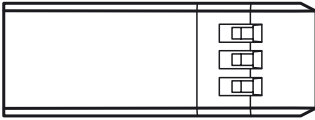

1	Operating indicator
---	---------------------

**Receiver**

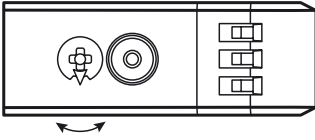

1	Sensitivity adjustment	
2	Light-on / dark-on changeover switch	
3	Operating indicator / dark on	
4	Signal indicator	
5	Operating indicator / light on	

**Accessories**

**IO-Link-Master02-USB**

IO-Link master, supply via USB port or separate power supply, LED indicators, M12 plug for sensor connection

**V31-WM-2M-PUR**

Female cordset single-ended, M8, 4-pin, PUR cable

**V31-GM-2M-PUR**

Female cordset single-ended, M8, 4-pin, PUR cable

**OMH-RL31-02**

Mounting bracket narrow

**OMH-RL31-03**

Mounting bracket narrow

**OMH-RL31-04**

Mounting aid for round steel  $\varnothing$  12 mm or sheet 1.5 mm ... 3 mm

**OMH-RL31-07**

Mounting bracket including adjustment

**OMH-R20x-Quick-Mount**

Quick mounting accessory

Other suitable accessories can be found at [www.pepperl-fuchs.com](http://www.pepperl-fuchs.com)

Technical data	
<b>System components</b>	
Emitter	OBE25M-R201-S-IO-0,3M-V31
Receiver	OBE25M-R201-2EP-IO-0,3M-V31
<b>General specifications</b>	
Effective detection range	0 ... 25 m
Threshold detection range	33 m
Light source	LED
Light type	modulated visible red light
LED risk group labelling	exempt group
Alignment aid	LED red (in receiver lens) illuminated constantly: beam is interrupted, flashes: reaching switching point, off: sufficient stability control
Diameter of the light spot	approx. 850 mm at a distance of 25 m
Angle of divergence	approx. 2 °
Ambient light limit	EN 60947-5-2 : 40000 Lux
<b>Functional safety related parameters</b>	
MTTF <sub>d</sub>	462 a
Mission Time (T <sub>M</sub> )	20 a
Diagnostic Coverage (DC)	60 %
<b>Indicators/operating means</b>	
Operation indicator	LED green: constantly on - power on flashing (4Hz) - short circuit flashing with short break (1 Hz) - IO-Link mode
Function indicator	Yellow LED: Permanently lit - light path clear Permanently off - object detected Flashing (4 Hz) - insufficient operating reserve
Control elements	Receiver: light/dark switch
Control elements	Receiver: sensitivity adjustment
<b>Electrical specifications</b>	
Operating voltage	U <sub>B</sub> 10 ... 30 V DC
Ripple	max. 10 %
No-load supply current	I <sub>0</sub> Emitter: ≤ 15 mA Receiver: ≤ 15 mA at 24 V Operating voltage
Protection class	III
<b>Interface</b>	
Interface type	IO-Link ( via C/Q = pin 4 )
Device profile	Identification and diagnosis Smart Sensor: Receiver: type 2.4 Emitter: -
Transfer rate	COM 2 (38.4 kBaud)
IO-Link Revision	1.1
Min. cycle time	2.3 ms
Process data width	Emitter: Process data input: 0 bit Process data output: 1 bit Receiver: Process data input: 2 bit Process data output: 2 bit
SIO mode support	yes
Device ID	Emitter: 0x111411 (1119249) Receiver: 0x111311 (1118993)
Compatible master port type	A
<b>Input</b>	
Test input	emitter deactivation at +U <sub>B</sub>
<b>Output</b>	
Switching type	The switching type of the sensor is adjustable. The default setting is: C/Q - Pin4: NPN normally open / dark-on, PNP normally closed / light-on, IO-Link /Q - Pin2: NPN normally closed / light-on, PNP normally open / dark-on
Signal output	2 push-pull (4 in 1) outputs, short-circuit protected, reverse polarity protected, overvoltage protected
Switching voltage	max. 30 V DC
Switching current	max. 100 mA , resistive load
Usage category	DC-12 and DC-13
Voltage drop	U <sub>d</sub> ≤ 1.5 V DC
Switching frequency	f 1000 Hz
Response time	0.5 ms
<b>Conformity</b>	
Communication interface	IEC 61131-9
Product standard	EN 60947-5-2
<b>Ambient conditions</b>	

Release date: 2018-05-23 09:21 Date of issue: 2019-10-31 301106\_eng.xml

Refer to "General Notes Relating to Pepperl+Fuchs Product Information".

Ambient temperature	-40 ... 60 °C (-40 ... 140 °F) , fixed cable -20 ... 60 °C (-4 ... 140 °F) , movable cable not appropriate for conveyor chains
Storage temperature	-40 ... 70 °C (-40 ... 158 °F)

**Mechanical specifications**

Housing width	15 mm
Housing height	61.7 mm
Housing depth	41.7 mm
Degree of protection	IP67 / IP69 / IP69K
Connection	fixed cable 300 mm with M8 x 1 male connector; 4-pin
Material	
Housing	PC (Polycarbonate)
Optical face	PMMA
Mass	Emitter: approx. 51 g receiver: approx. 51 g
Cable length	0.3 m

**Approvals and certificates**

UL approval	E87056 , cULus Listed , class 2 power supply , type rating 1
CCC approval	CCC approval / marking not required for products rated ≤36 V

**Curves/Diagrams**

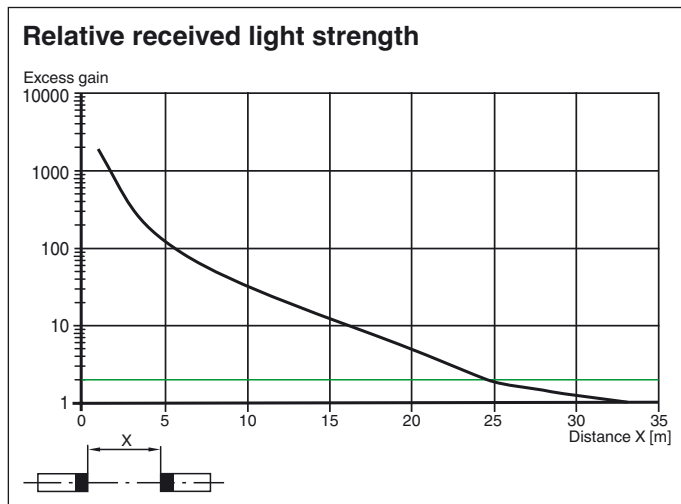
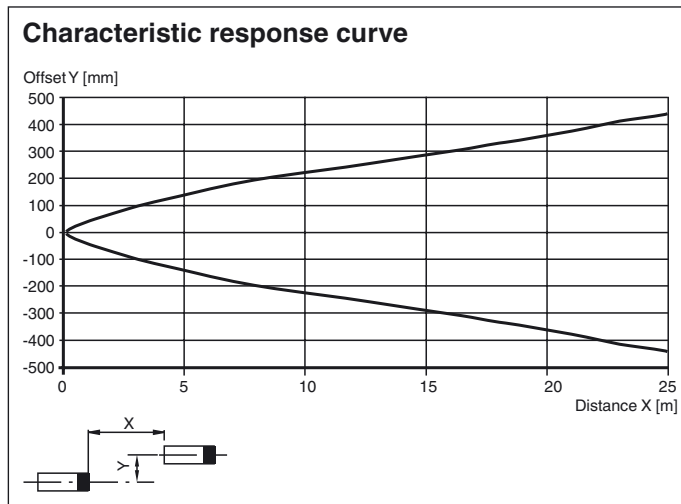

**Functions and Operation**

To unlock the adjustment functions turn the sensing range /sensitivity adjuster for more than 180 degrees.

**Sensing Range / Sensitivity**

Turn sensing range / sensitivity adjuster clockwise to increase sensing range / sensitivity.

Turn sensing range / sensitivity adjuster counter clockwise to decrease sensing range / sensitivity.

If the end of the adjustment range is reached, the signal indicator starts flashing with 8 Hz.

**Light-on / Dark-on Configuration**

Press the light-on / dark-on changeover switch for more than 1 second (less than 4 seconds). The light-on / dark-on mode changes and the operating indicators are activated accordingly.

Release date: 2018-05-23 09:21 Date of issue: 2019-10-31 301106\_eng.xml

If you press the light-on / dark-on changeover switch for more than 4 seconds, the light-on /dark-on mode changes back to the original setting. On release of the light-on / dark-on changeover switch the current state is activated.

### Restore Factory Settings

Press the light-on / dark-on changeover switch for more than 10 seconds (less than 30 seconds) until all LEDs turn off. On release of the light-on / dark-on changeover switch the signal indicator turns on. After 5 seconds the sensor resumes operation with factory default settings.

After 5 minutes of inactivity the sensing range / sensitivity adjustment is locked. In order to reactivate the sensing range / sensitivity adjustment, turn the sensing range /sensitivity adjuster for more than 180 degrees.