



**Model Number**

**ML29-P/59/103/143**

Thru-beam sensor  
4-pin plastic connector, 6.5 mm diameter

**Features**

- Single-beam monitoring with extremely narrow sensor
- Integrated circuit
- Test
- Simple installation - Plug & Play
- Ideal for installation in door profiles or frames
- Dark on version

**Product information**

The narrow miniature thru-beam sensors are a small and cost-effective solution, fitting in virtually any door frame. The ML29 and ML30 series offer fast, reliable detection at a distance of up to 8.5 m. The sensors are easy to mount on the profile, either using adhesive strips or a screw. A large opening angle ensures problem-free alignment. Several sensors can be mounted in a cross formation to offer multi-beam protection.

Release date: 2019-12-18 11:19 Date of issue: 2019-12-18 129316\_eng.xml

**Dimensions**

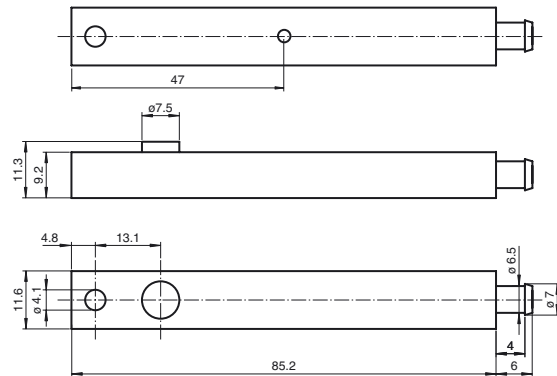

**Electrical connection**

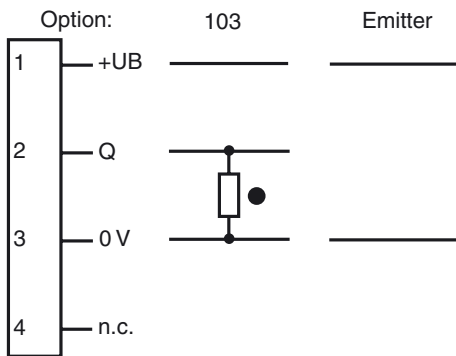

○ = Light on  
● = Dark on

**Pinout**

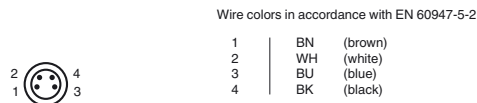

**Indicators/operating means**

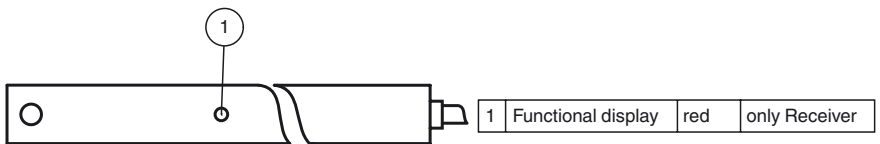

**Technical data**

**System components**

Emitter	ML29-T/143
Receiver	ML29-R/59/103/143

**General specifications**

Effective detection range	0 ... 6 m
Threshold detection range	8.5 m
Light source	IREDD
Light type	modulated infrared light
Angle of divergence	+/- 8 °
Optical face	lateral
Ambient light limit	40000 Lux

**Functional safety related parameters**

MTTF <sub>d</sub>	880 a
Mission Time (T <sub>M</sub> )	20 a
Diagnostic Coverage (DC)	0 %

**Indicators/operating means**

Function indicator	LED red in receiver : lights up when receiving the light beam
--------------------	---

**Electrical specifications**

Operating voltage	U <sub>B</sub>	11 ... 30 V DC
No-load supply current	I <sub>0</sub>	Emitter: ≤ 25 mA Receiver: ≤ 10 mA

**Input**

Test input	Test: Transmitter switches off at +U <sub>B</sub> ≤ 5 V DC
------------	--

**Output**

Switching type	dark on	
Signal output	1 PNP output, short-circuit protected, reverse polarity protected, open collector	
Switching voltage	max. 30 V DC	
Switching current	max. 0.1 A	
Switching frequency	f	100 Hz
Response time	5 ms	

**Conformity**

Product standard	EN 60947-5-2
------------------	--------------

**Ambient conditions**

Ambient temperature	-20 ... 60 °C (-4 ... 140 °F)
Storage temperature	-20 ... 75 °C (-4 ... 167 °F)
Relative humidity	90 % , noncondensing

**Mechanical specifications**

Degree of protection	IP65
Connection	4-pin plastic connector, 6.5 mm diameter
Material	
Housing	PMMA , black
Optical face	Plastic pane
Mass	per device 120 g

**Compliance with standards and directives**

Standard conformity	
Standards	EN 61000-6-2, EN 61000-6-3

**Approvals and certificates**

CCC approval	CCC approval / marking not required for products rated ≤36 V
--------------	--

**Curves/Diagrams**

**Characteristic response curve**

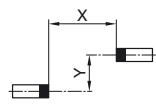
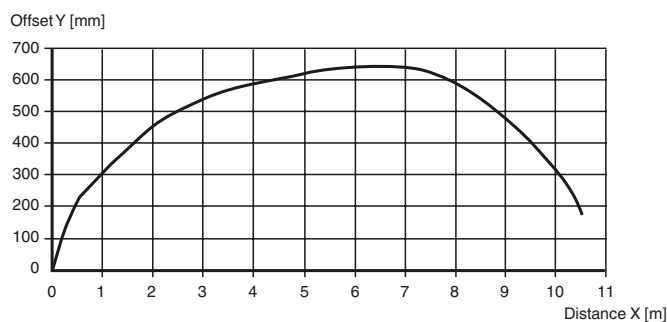

**Typical applications**

- Person detection for automatic doors and gates
- Closing edge protection on sliding and revolving doors
- Threshold monitoring for elevator doors
- Step monitoring for doors on public transport vehicles
- Trigger function for restarting escalators

**Detection area**

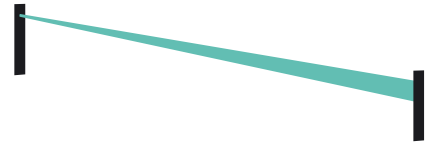

**Accessories**

**ML29 Kupplungsdose 6m 4polig**

Female cordset with 6 m cable for ML29 series sensors

**ML29 Front Plate**

Front plate for thru-beam sensors in series ML29

**ML29 Kupplungsdose 3m 4polig**

Female cordset with 3 m cable for ML29 series sensors

Other suitable accessories can be found at [www.pepperl-fuchs.com](http://www.pepperl-fuchs.com)

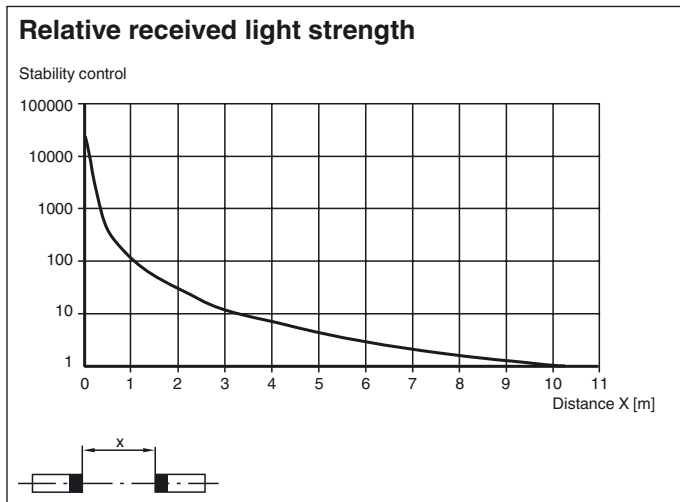

**Function principle**

The thru-beam sensor requires a pair of devices for operation, comprising a light transmitter and a light receiver. The emitter and receiver must be arranged in optical alignment with each other. The infrared light from the emitter is detected by the receiver and evaluated.

**Function**

**Static detection:**

The thru-beam sensor detects persons and objects independently of movement and surface structure for as long as the object breaks the detection beam.

		Electronic output
Light detection /25	Person in the beam	Inactive
	No person in the beam	Active
Dark detection /59	Person in the beam	Active
	No person in the beam	Inactive

**Optics:**

The relatively wide opening angles enable the light beam switches to be installed quickly, without alignment problems. Even if there is a light distortion of the installation profiles the function is retained.

**Testing:**

Testing is used to check the function of the light beam switch.

With supply voltage  $+U_B < 5\text{ V}$  the emitter device is switched off. This simulates a light beam interruption. By means of this, the function of the light barrier can be tested easily without using a separate test input.

**Installation:**

Thanks to its small dimensions, the light beam can be fitted in a U-profile or behind a face panel. The hole diameter for both the emitter and the receiver is 8 mm.

Even fixing by means of the adhesive tape contained in the delivery package can be considered.

**Installation of twin-beam arrangement:**

Release date: 2019-12-18 11:19 Date of issue: 2019-12-18 129316\_eng.xml

A twin-beam version requires 2 emitters and receivers. Care should be taken that the beam separation is not less than 20 cm. The transmitters and receivers must be arranged in the form of a cross.

