



**Model Number**

**OBT350-R101-2EP-IO**

Triangulation sensor (BGS)  
with fixed cable

**Features**

- Miniature design with versatile mounting options
- Best background suppressor in its class
- Precision object detection, almost irrespective of the color
- Extended temperature range -40°C ... 60°C
- High degree of protection IP69K
- IO-link interface for service and process data

**Product information**

The miniature optical sensors are the first devices of their kind to offer an end-to-end solution in a small single standard design — from thru-beam sensor through to a distance measurement device. As a result of this design, the sensors are able to perform practically all standard automation tasks.

The DuraBeam laser sensors are durable and can be used in the same way as a standard sensor.

The use of Multi Pixel Technology gives the standard sensors a high level of flexibility and enables them to adapt more effectively to their operating environment.

**Dimensions**

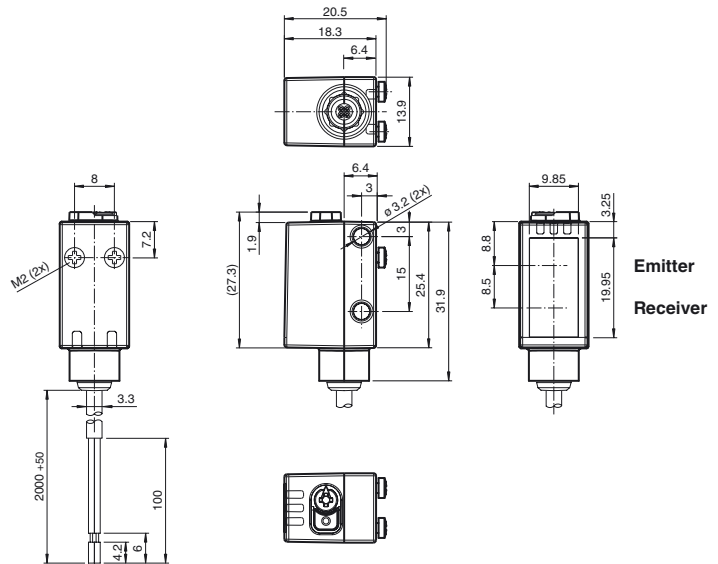

**Electrical connection**

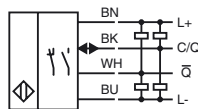

**Indicators/operating means**

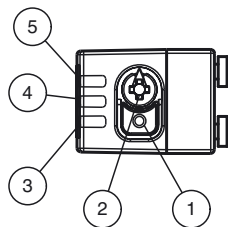

1	Light-on/dark-on changeover switch
2	Sensing range adjuster
3	Operating indicator / dark on
4	Signal indicator
5	Operating indicator / light on

Release date: 2019-03-26 09:57 Date of issue: 2019-03-26 267075-0094\_eng.xml

Refer to "General Notes Relating to Pepperl+Fuchs Product Information".

Pepperl+Fuchs Group  
www.pepperl-fuchs.com

USA: +1 330 486 0001  
fa-info@us.pepperl-fuchs.com

Germany: +49 621 776 1111  
fa-info@de.pepperl-fuchs.com

Singapore: +65 6779 9091  
fa-info@sg.pepperl-fuchs.com

**PEPPERL+FUCHS**

**Technical data****General specifications**

Detection range	5 ... 350 mm
Detection range min.	5 ... 25 mm
Detection range max.	5 ... 350 mm
Adjustment range	25 ... 350 mm
Reference target	standard white, 100 mm x 100 mm
Light source	LED
Light type	modulated visible red light
LED risk group labelling	exempt group
Black/White difference (6%/90%)	< 15 % at 350 mm
Diameter of the light spot	approx. 20 mm at a distance of 350 mm
Angle of divergence	approx. 3 °
Ambient light limit	EN 60947-5-2 : 40000 Lux

**Functional safety related parameters**

MTTF <sub>d</sub>	600 a
Mission Time (T <sub>M</sub> )	20 a
Diagnostic Coverage (DC)	0 %

**Indicators/operating means**

Operation indicator	LED green: constantly on - power on flashing (4Hz) - short circuit flashing with short break (1 Hz) - IO-Link mode
Function indicator	LED yellow: constantly on - object detected constantly off - object not detected
Control elements	Light-on/dark-on changeover switch
Control elements	Sensing range adjuster

**Electrical specifications**

Operating voltage	U <sub>B</sub>	10 ... 30 V DC
Ripple		max. 10 %
No-load supply current	I <sub>0</sub>	< 25 mA at 24 V supply voltage
Protection class		III

**Interface**

Interface type	IO-Link ( via C/Q = BK )
Device profile	Smart Sensor
Transfer rate	COM 2 (38.4 kBaud)
IO-Link Revision	1.1
Min. cycle time	2.3 ms
Process data width	Process data input 1 Bit Process data output 2 Bit
SIO mode support	yes
Device ID	0x110601 (1115649)
Compatible master port type	A

**Output**

Switching type	The switching type of the sensor is adjustable. The default setting is: C/Q - BK: NPN normally open / light-on, PNP normally closed / dark-on, IO-Link /Q - WH: NPN normally closed / dark-on, PNP normally open / light-on	
Signal output	2 push-pull (4 in 1) outputs, short-circuit protected, reverse polarity protected, overvoltage protected	
Switching voltage	max. 30 V DC	
Switching current	max. 100 mA , resistive load	
Usage category	DC-12 and DC-13	
Voltage drop	U <sub>d</sub>	≤ 1.5 V DC
Switching frequency	f	500 Hz
Response time		1 ms

**Conformity**

Communication interface	IEC 61131-9
Product standard	EN 60947-5-2

**Ambient conditions**

Ambient temperature	-40 ... 60 °C (-40 ... 140 °F) , fixed cable -25 ... 60 °C (-13 ... 140 °F) , movable cable not appropriate for conveyor chains
Storage temperature	-40 ... 70 °C (-40 ... 158 °F)

**Mechanical specifications**

Housing width	13.9 mm
Housing height	33.8 mm
Housing depth	18.3 mm
Degree of protection	IP67 / IP69 / IP69K
Connection	2 m fixed cable
Material	
Housing	PC (Polycarbonate)
Optical face	PMMA
Mass	approx. 36 g

**Accessories****IO-Link-Master02-USB**

IO-Link master, supply via USB port or separate power supply, LED indicators, M12 plug for sensor connection

Other suitable accessories can be found at [www.pepperl-fuchs.com](http://www.pepperl-fuchs.com)

Cable length 2 m

**Approvals and certificates**

UL approval E87056 , cULus Listed , class 2 power supply , type rating 1

**Curves/Diagrams**

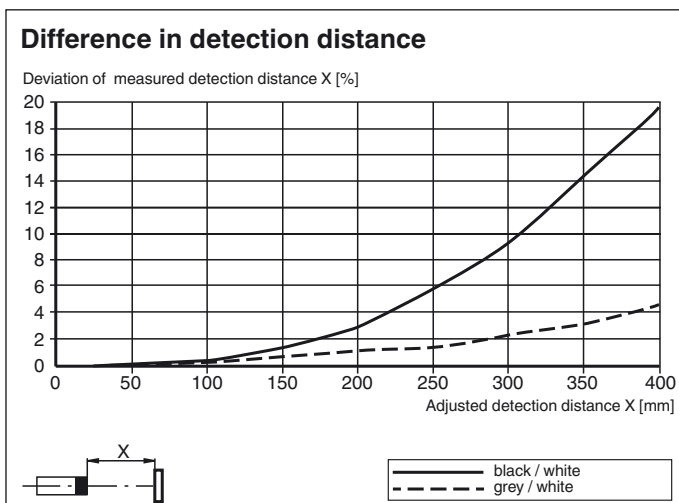
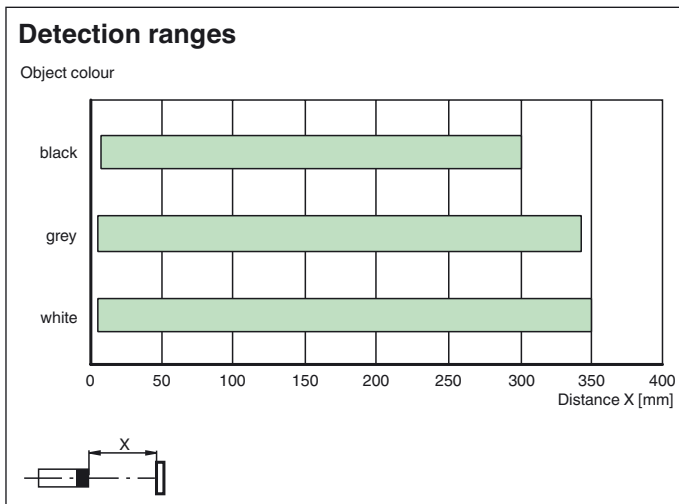
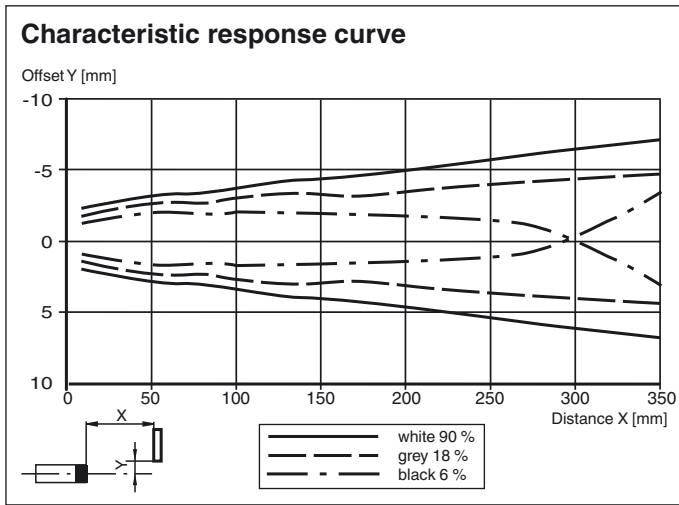

Release date: 2019-03-26 09:57 Date of issue: 2019-03-26 267075-0094\_eng.xml

Refer to "General Notes Relating to Pepperl+Fuchs Product Information".

## Functions and Operation

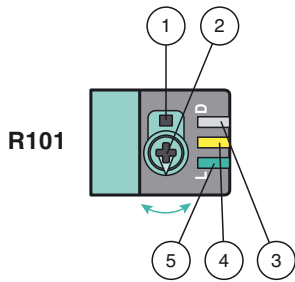

- 1 - Light-on / dark-on changeover switch
- 2 - Sensing range /sensitivity adjuster
- 3 - Operating indicator / dark on
- 4 - Signal indicator
- 5 - Operating indicator / light on

To unlock the adjustment functions turn the sensing range adjuster for more than 180 degrees.

### Sensing Range / Sensitivity

Turn sensing range / sensitivity adjuster clockwise to increase sensing range / sensitivity.

Turn sensing range /sensitivity adjuster counter clockwise to decrease sensing range / sensitivity.

If the end of the adjustment range is reached, the signal indicator starts flashing with 8 Hz.

### Light-on / Dark-on Configuration

Press the light-on / dark-on changeover switch for more than 1 second (less than 4 seconds). The light-on / dark-on mode changes and the operating indicators are activated accordingly.

If you press the light-on / dark-on changeover switch for more than 4 seconds, the light-on / dark-on mode changes back to the original setting. On release of the light-on / dark-on changeover switch the current state is activated.

### Restore Factory Settings

Press the light-on / dark-on changeover switch for more than 10 seconds (less than 30 seconds) until all LEDs turn off. On release of the light-on / dark-on changeover switch the signal indicator turns on. After 5 seconds the sensor resumes operation with factory default settings.

After 5 minutes of inactivity the sensing range / sensitivity adjustment is locked. In order to reactivate the sensing range /sensitivity adjustment, turn the sensing range / sensitivity adjuster for more than 180 degrees.