



**Model Number**

**OBT300-R201-2EP-IO-0,3M-V31**  
 Triangulation sensor (BGS)  
 with fixed cable and 4-pin, M8 connector

**Features**

- Medium design with versatile mounting options
- Best background suppressor in its class
- Precision object detection, almost irrespective of the color
- Extended temperature range -40°C ... 60°C
- High degree of protection IP69K
- IO-link interface for service and process data

**Product information**

The optical sensors in the series are the first devices to offer an end-to-end solution in a medium-sized standard design—from the thru-beam sensor through to the measuring distance sensor. As a result of this design, the sensors are able to perform practically all standard automation tasks. The entire series enables sensors to communicate via IO-Link. The DuraBeam laser sensors are durable and can be used in the same way as a standard sensor. Multi Pixel Technology (MPT) ensures that the standard sensors are flexible and can be adapted to the application environment.

**Dimensions**

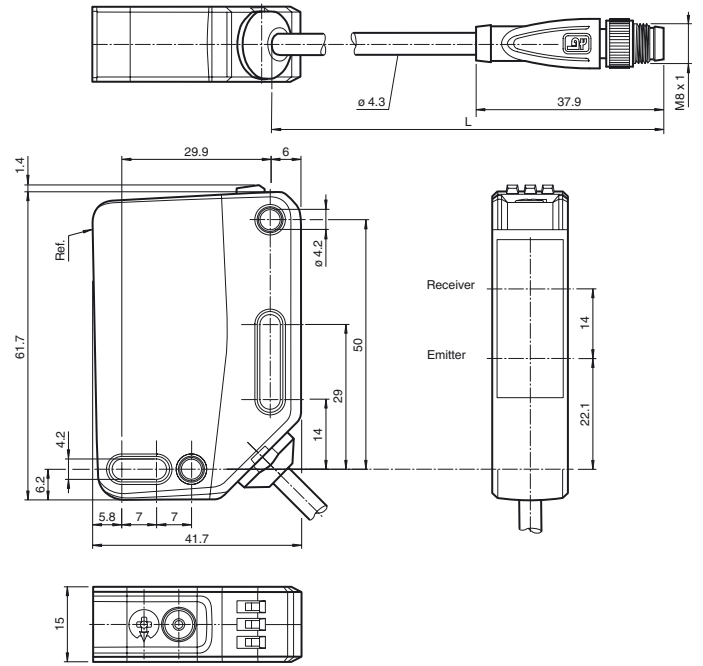

**Electrical connection**

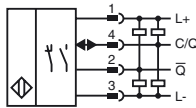

**Pinout**

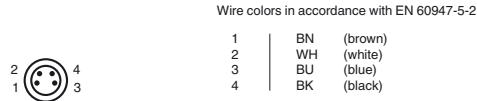

**Indicators/operating means**

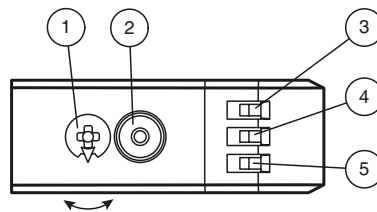

1	Sensitivity adjustment	
2	Light-on / dark-on changeover switch	
3	Operating indicator / dark on	GN
4	Signal indicator	YE
5	Operating indicator / light on	GN

Release date: 2018-05-23 09:22 Date of issue: 2019-10-31 295670-100212\_eng.xml

Refer to "General Notes Relating to Pepperl+Fuchs Product Information".

**Technical data****General specifications**

Detection range	30 ... 300 mm
Detection range min.	30 ... 80 mm
Detection range max.	30 ... 300 mm
Adjustment range	80 ... 300 mm
Reference target	standard white, 100 mm x 100 mm
Light source	LED
Light type	modulated visible red light
LED risk group labelling	exempt group
Black/White difference (6%/90%)	< 5 % at 300 mm
Diameter of the light spot	approx. 8 mm x 8 mm at a distance of 300 mm
Angle of divergence	approx. 1.5 °
Ambient light limit	EN 60947-5-2 : 70000 Lux

**Functional safety related parameters**

MTTF <sub>d</sub>	600 a
Mission Time (T <sub>M</sub> )	20 a
Diagnostic Coverage (DC)	0 %

**Indicators/operating means**

Operation indicator	LED green: constantly on - power on flashing (4Hz) - short circuit flashing with short break (1 Hz) - IO-Link mode
Function indicator	LED yellow: constantly on - object detected constantly off - object not detected
Control elements	Light-on/dark-on changeover switch
Control elements	Sensing range adjuster

**Electrical specifications**

Operating voltage	U <sub>B</sub>	10 ... 30 V DC
Ripple		max. 10 %
No-load supply current	I <sub>0</sub>	< 26 mA at 24 V supply voltage
Protection class		III

**Interface**

Interface type	IO-Link ( via C/Q = pin 4 )
Device profile	Identification and diagnosis Smart Sensor type 2.4
Transfer rate	COM 2 (38.4 kBaud)
IO-Link Revision	1.1
Min. cycle time	2.3 ms
Process data width	Process data input 1 Bit Process data output 2 Bit
SIO mode support	yes
Device ID	0x111612 (1119762)
Compatible master port type	A

**Output**

Switching type	The switching type of the sensor is adjustable. The default setting is: C/Q - Pin4: NPN normally open / light-on, PNP normally closed / dark-on, IO-Link /Q - Pin2: NPN normally closed / dark-on, PNP normally open / light-on	
Signal output	2 push-pull (4 in 1) outputs, short-circuit protected, reverse polarity protected, overvoltage protected	
Switching voltage	max. 30 V DC	
Switching current	max. 100 mA , resistive load	
Usage category	DC-12 and DC-13	
Voltage drop	U <sub>d</sub>	≤ 1.5 V DC
Switching frequency	f	500 Hz
Response time		1 ms

**Conformity**

Communication interface	IEC 61131-9
Product standard	EN 60947-5-2

**Ambient conditions**

Ambient temperature	-40 ... 60 °C (-40 ... 140 °F) , fixed cable -20 ... 60 °C (-4 ... 140 °F) , movable cable not appropriate for conveyor chains
Storage temperature	-40 ... 70 °C (-40 ... 158 °F)

**Mechanical specifications**

Housing width	15 mm
Housing height	61.7 mm
Housing depth	41.7 mm
Degree of protection	IP67 / IP69 / IP69K
Connection	fixed cable 300 mm with M8 x 1 male connector; 4-pin
Material	
Housing	PC (Polycarbonate)
Optical face	PMMA

**Accessories****IO-Link-Master02-USB**

IO-Link master, supply via USB port or separate power supply, LED indicators, M12 plug for sensor connection

**V31-WM-2M-PUR**

Female cordset single-ended, M8, 4-pin, PUR cable

**V31-GM-2M-PUR**

Female cordset single-ended, M8, 4-pin, PUR cable

**OMH-RL31-02**

Mounting bracket narrow

**OMH-RL31-03**

Mounting bracket narrow

**OMH-RL31-04**

Mounting aid for round steel ø 12 mm or sheet 1.5 mm ... 3 mm

**OMH-RL31-07**

Mounting bracket including adjustment

**OMH-R20x-Quick-Mount**

Quick mounting accessory

Other suitable accessories can be found at [www.pepperl-fuchs.com](http://www.pepperl-fuchs.com)

Mass	approx. 52 g
Cable length	0.3 m

**Approvals and certificates**

UL approval	E87056 , cULus Listed , class 2 power supply , type rating 1
CCC approval	CCC approval / marking not required for products rated ≤36 V

**Curves/Diagrams**

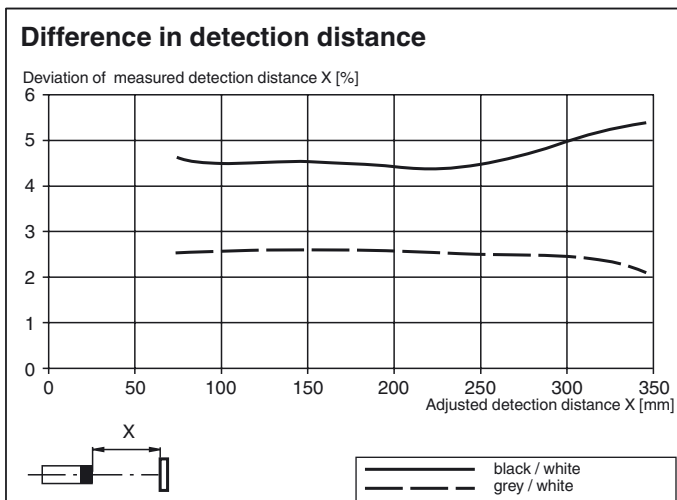
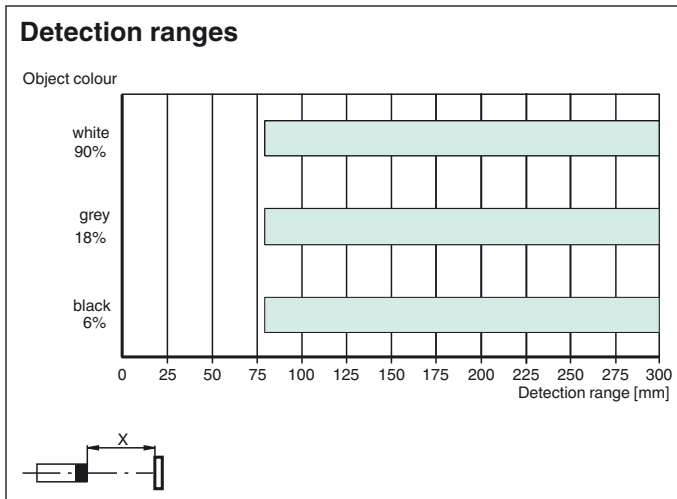
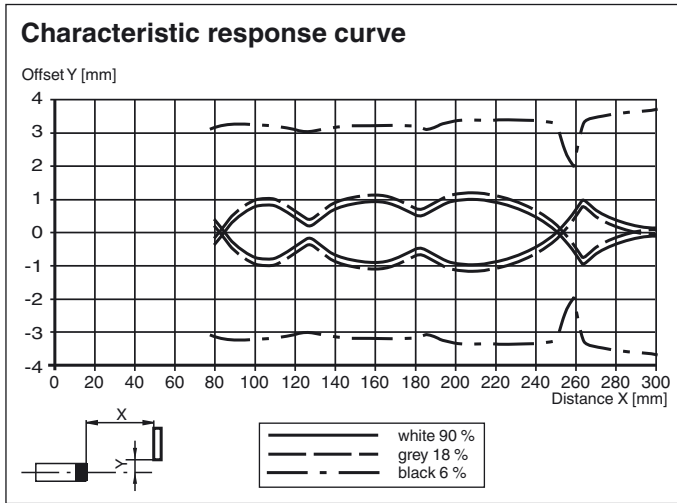

Release date: 2018-05-23 09:22 Date of issue: 2019-10-31 295670-100212\_eng.xml

To unlock the adjustment functions, rotate the sensing range/sensitivity adjuster by more than 180°.

**Sensing Range/Sensitivity**

To increase the sensing range/sensitivity, rotate the sensing range/sensitivity adjuster clockwise.

To reduce the sensing range/sensitivity, rotate the sensing range/sensitivity adjuster counter-clockwise.

Refer to "General Notes Relating to Pepperl+Fuchs Product Information".

As soon as the end of the adjustment range is reached, the signal indicator flashes at 8 Hz.

### Configuring Light On/Dark On

Press the light-on/dark-on changeover switch for more than 1 second (but less than 4 seconds). "Light on/dark on" mode changes and the relevant operating indicator lights up.

If you press the light-on/dark-on changeover switch for longer than 4 seconds, the "light on/dark on" mode will switch back to the original setting. The current status is activated when the light-on/dark-on changeover switch is released.

### Restoring Factory Settings

Press the light-on/dark-on changeover switch for more than 10 seconds (but less than 30 seconds) until all LEDs go out. When the light-on/dark-on changeover switch is released, the signal indicator lights up. After 5 seconds, the sensor resumes operation with the factory settings.

The adjustment functions are locked after 5 minutes of inactivity. To unlock the adjustment functions, rotate the sensing range/sensitivity adjuster again by more than 180°.