



Model Number

WTS10-12/21/105

Diffuse mode sensor
with 5-pin, M12 x 1 connector

Features

- Specifically for quality checks on welding caps
- Upper and lower welding caps checked simultaneously
- High position and angle tolerance insensitivity of the welding cap
- Pre-fault indication
- Scratch resistant mineral glass lens

Product information

The welding tip sensor WTS10 series is a contrast evaluation sensor with a large and homogeneous light spot fitted to check the quality of the welding cap's face after milling of the welding tip and which is widely used for industrial welding robots.

After the milling process of the welding cap, both tips of the welding gun are inspected and defects such as inclusions, faulty milling or burrs are detected.

Simultaneous control of the quality of both welding tip caps with one sensor is possible by providing two optical outputs on either side of the sensor housing.

The WTS10 features an extended detection area of 11 mm diameter, an uniform lightspot over the full sensing range due to coaxial optics beam path, a new display concept, high switching accuracy, a homogenous light spot and improved position and tilting angle tolerance.

Dimensions

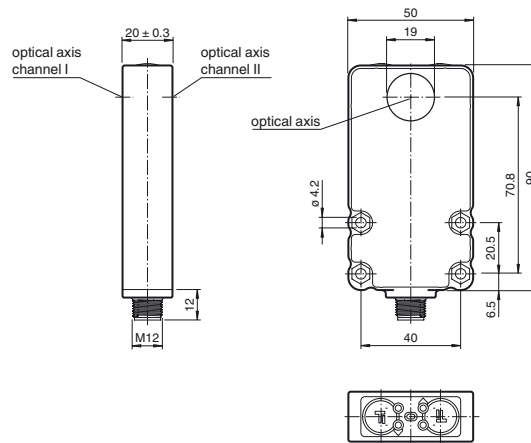

Electrical connection

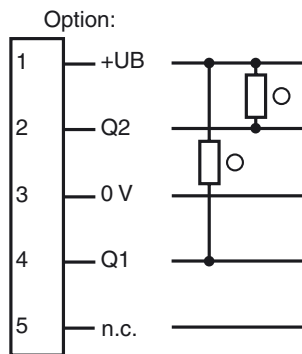

Pinout

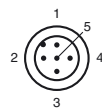

Wire colors in accordance with EN 60947-5-2

1	BN	(brown)
2	WH	(white)
3	BU	(blue)
4	BK	(black)
5	GY	(gray)

Indicators/operating means

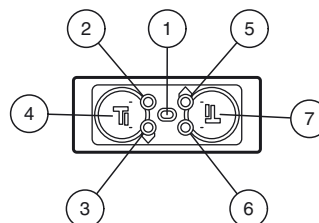

1	LED Power On	green
2	LED channel I	red
3	LED channel I	yellow
4	Teach-In channel I	
5	LED channel II	yellow
6	LED channel II	red
7	Teach-In channel II	

Release date: 2018-02-15 08:52 Date of issue: 2018-02-15 223093_eng.xml

Technical data**General specifications**

Detection range	2 ... 12 mm
Reference target	Copper welding-electrode Diameter: 16 mm , Front end: 6 mm
Light source	LED
Light type	modulated visible red light , 640 nm
Ambient light limit	continuous light 40000 Lux , Modulated light 5000 Lux
Tilting angle	± 1.5 °
Position tolerance	± 2 mm

Indicators/operating means

Operation indicator	LED green: Power on
Function indicator	LED yellow: switching state LED red: Pre-fault indication
Teach-In indicator	LED, green/yellow flashing (approx. 4 Hz) Teach Error:LED green/yellow non equiphase flashing; 8.0 Hz
Control elements	Teach-In key

Electrical specifications

Operating voltage	U_B	10 ... 30 V DC
No-load supply current	I_0	≤ 70 mA

Output

Switching type	light on
Signal output	2 switch outputs NPN, NO short-circuit protected reverse polarity protected
Switching current	max. 100 mA
Switching frequency	f 100 Hz
Response time	5 ms

Ambient conditions

Ambient temperature	0 ... 50 °C (32 ... 122 °F) The switching accuracy will remain, if the temperature after Teach-In does not varies more than ±7 °C
Storage temperature	-20 ... 70 °C (-4 ... 158 °F)

Mechanical specifications

Degree of protection	IP67
Connection	5-pin, M12 x 1 connector
Material	
Housing	PC + ABS
Optical face	Scratch resistant mineral glass lens
Mass	80 g

Compliance with standards and directives

Standard conformity	
Product standard	EN 60947-5-2:2007 IEC 60947-5-2:2007
Shock and impact resistance	IEC / EN 60068. half-sine, 50 g in each X, Y and Z directions
Vibration resistance	IEC / EN 60068-2-6. Sinus. 10 -150 Hz, 5 g in each X, Y and Z directions

Approvals and certificates

Protection class	II, rated voltage ≤ 250 V AC with pollution degree 1-2 according to IEC 60664-1
UL approval	cULus Listed
CCC approval	CCC approval / marking not required for products rated ≤36 V

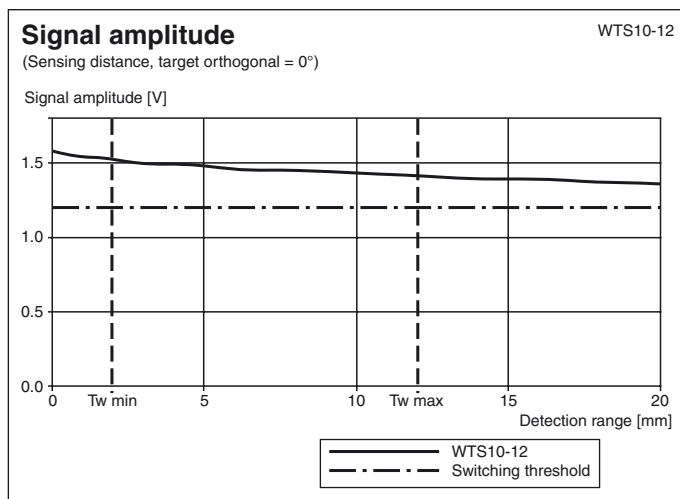
Curves/Diagrams**Accessories****OMH-WTS10-04**

Mounting bracket

OMH-WTS10-01

Mounting bracket for sensors of WTS10 series

V15-G-2M-PVC

Female cordset, M12, 5-pin, PVC cable

V15-G-2M-PUR

Female cordset, M12, 5-pin, PUR cable

V15-W-5M-PVC

Female cordset, M12, 5-pin, PVC cable

Other suitable accessories can be found at www.pepperl-fuchs.com

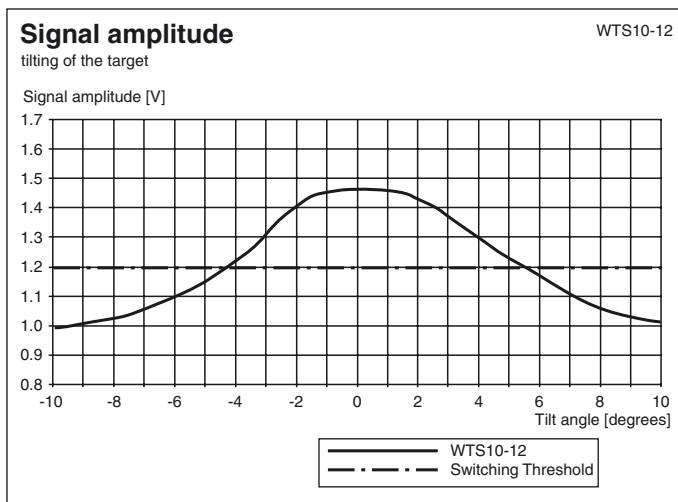
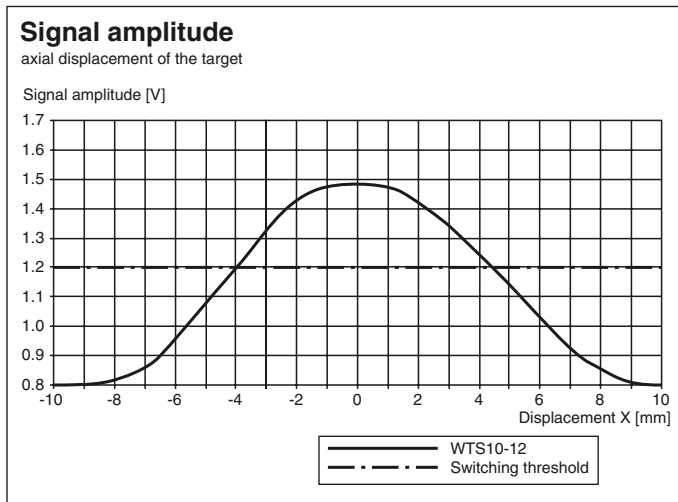

Teach-In

1. Position the reference welding cap in front of the optical system of the desired sensor channel. (channel I or channel II)
2. Press and hold the corresponding Teach-In button.
The keystroke is acknowledged by the sensor by the green display LED being extinguished for a short time (200 ms).
3. After 2 s the sensor switches to Teach-In mode:
both switch outputs are deactivated.
The sensor is taught the properly milled welding cap as a reference sample for the selected sensor channel.
The green LED and the yellow LED that belongs to the selected sensor channel flash in an equiphase manner.
Release the Teach-In button.
4. Teach-In completed:
The green LED and the yellow LED that belongs to the selected sensor channel flash for 2 s in an antiphase manner.
 - **Teach-In OK:**
The taught reference welding cap is permanently saved.
The sensor switches back to switching mode.
 - **Teach-In error:**
This is indicated by the green LED and the yellow LED that belongs to the selected sensor channel quickly flashing in an antiphase manner (approx. 8 Hz) for 5 s.
The taught values are discarded by the sensor; after 5 s the sensor switches to switching mode and works with the last valid values..
For signal levels below the fixed switching threshold value, the Teach-In mode can't be entered. A Teach-In error is indicated.