



Model Number

VT18-8-400-M-LAS/40a/118/128

Diffuse mode sensor
with 4-pin, M12 x 1 connector

Features

- M18 threaded housing made of brass, nickel plated
- Visible red light, pulsed LASER light
- Array control panel with highly visible LED display
- Flashing power on LED in case of short-circuit
- Multiple device installation possible, no mutual interference (no cross-talk)
- Not sensitive to ambient light, even with switched energy saving lamps
- Protection class II

Dimensions

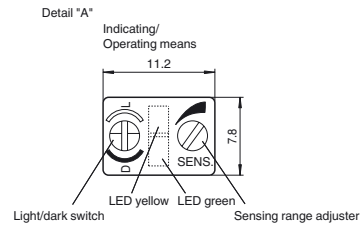
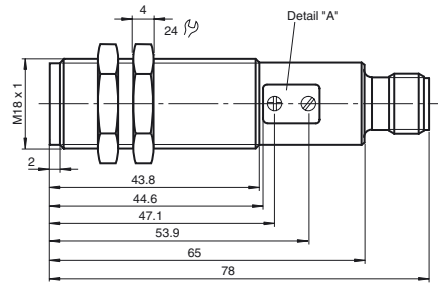

Electrical connection

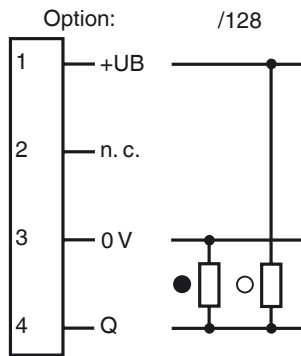

○ = Light on
● = Dark on

Pinout

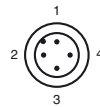

Wire colors in accordance with EN 60947-5-2

1	BN	(brown)
2	WH	(white)
3	BU	(blue)
4	BK	(black)

Release date: 2019-11-25 10:14 Date of issue: 2019-11-25 801135_eng.xml

Refer to "General Notes Relating to Pepperl+Fuchs Product Information".

Pepperl+Fuchs Group
www.pepperl-fuchs.com

USA: +1 330 486 0001
fa-info@us.pepperl-fuchs.com

Germany: +49 621 776 1111
fa-info@de.pepperl-fuchs.com

Singapore: +65 6779 9091
fa-info@sg.pepperl-fuchs.com

Technical data**General specifications**

Detection range	0 ... 400 mm , adjustable
Detection range min.	0 ... 25 mm
Detection range max.	0 ... 400 mm
Light source	laser diode
Light type	modulated visible red light
Laser nominal ratings	
Note	LASER LIGHT , DO NOT STARE INTO BEAM
Laser class	1
Wave length	655 nm
Beam divergence	31.5 mrad
Pulse length	4 µs
Repetition rate	11.91 kHz
max. pulse energy	4.95 nJ
Diameter of the light spot	approx. 0.5 mm at a distance of 120 mm
Optical face	frontal
Ambient light limit	30000 Lux
Hysteresis	H < 15 %

Functional safety related parameters

MTTF _d	700 a
Mission Time (T _M)	20 a
Diagnostic Coverage (DC)	0 %

Indicators/operating means

Operation indicator	LED green, flashes in case of short-circuit
Function indicator	LED yellow, lights up with receiver lit
Control elements	Sensing range adjuster, light-on/dark-on changeover switch

Electrical specifications

Operating voltage	U _B	10 ... 30 V DC , class 2
No-load supply current	I ₀	< 25 mA
Protection class		II , rated voltage ≤ 50 V AC with pollution degree 1-2 according to IEC 60664-1

Output

Switching type	light/dark on, switchable	
Signal output	Push-pull output, short-circuit protected, reverse polarity protected	
Switching voltage	30 V DC	
Switching current	max. 200 mA	
Switching frequency	f	500 Hz
Response time	1 ms	

Conformity

Product standard	EN 60947-5-2
------------------	--------------

Ambient conditions

Ambient temperature	-25 ... 55 °C (-13 ... 131 °F)
Storage temperature	-30 ... 70 °C (-22 ... 158 °F)

Mechanical specifications

Degree of protection	IP67
Connection	4-pin, M12 x 1 connector
Material	
Housing	brass, nickel-plated
Optical face	PMMA
Mass	60 g

Compliance with standards and directives

Standard conformity	
Laser class	IEC 60825-1:2007 Complies with 21 CFR 1040.10 and 1040.11 except for deviations pursuant to Laser Notice No. 50, dated June 24, 2007

Approvals and certificates

CE conformity	yes
UL approval	cULus Listed, Type 1 enclosure
CCC approval	CCC approval / marking not required for products rated ≤36 V

Accessories**OMH-VL18**

Mounting Bracket with swivel nut

BF 18

Mounting flange, 18 mm

BF 18-F

Plastic mounting adapter, 18 mm

BF 5-30

Universal mounting bracket for cylindrical sensors with a diameter of 5 ... 30 mm

V1-G-2M-PUR

Female cordset, M12, 4-pin, PUR cable

V1-W-2M-PUR

Female cordset, M12, 4-pin, PUR cable

Other suitable accessories can be found at www.pepperl-fuchs.com

Curves/Diagrams

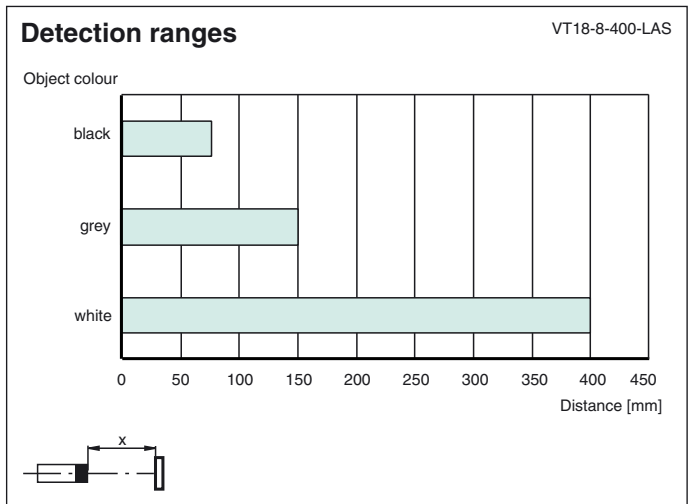
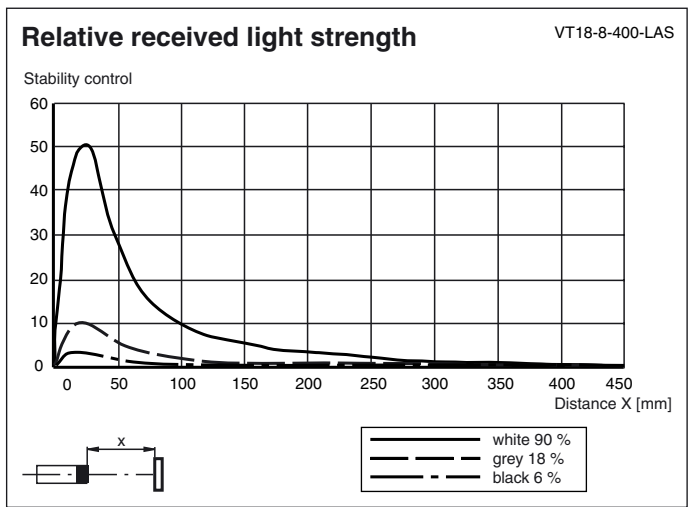
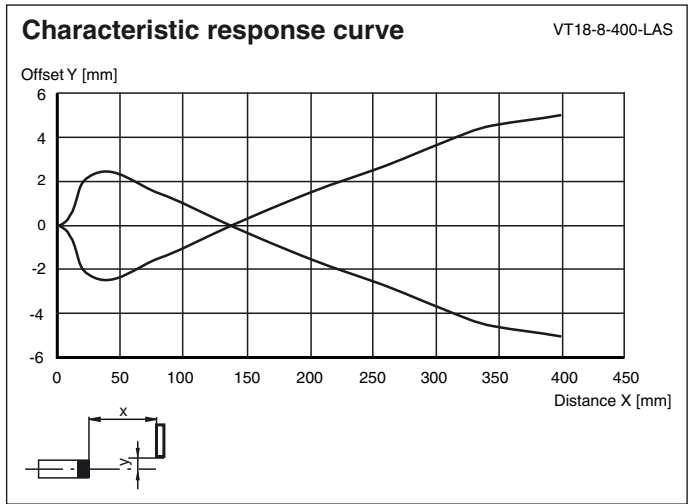

Release date: 2019-11-25 10:14 Date of issue: 2019-11-25 801135_eng.xml

Refer to "General Notes Relating to Pepperl+Fuchs Product Information".

Curves/Diagrams

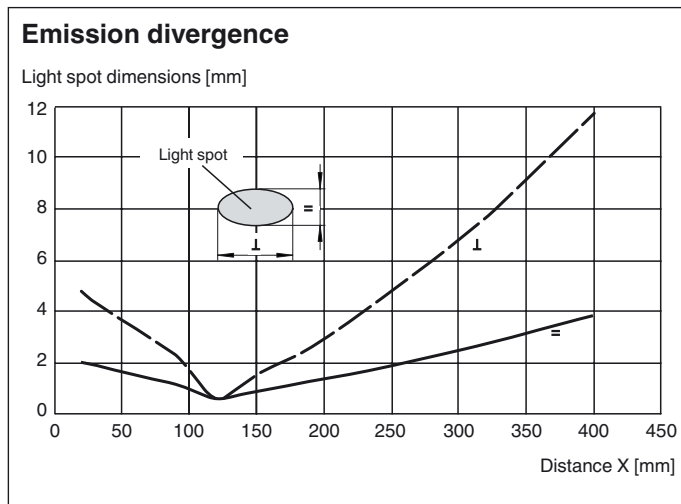

Adjustment

Sensitivity adjustment

- Turn sensitivity adjuster (counterclockwise) to minimum position.
- Place the object to be detected in the sensing range and turn the sensitivity adjuster clockwise until the yellow indication LED lights up. This setting indicates the position A of the sensitivity adjuster.
- Remove the object. Increase the sensitivity slowly (turning the sensitivity adjuster clockwise) until the yellow LED lights up again. This setting indicates the position B of the sensitivity adjuster.

Note:

In case of no background object, the LED won't light up, even in MAX. adjustment. In that case take care, that in normal operation conditions no temporal background object can appear in the sensing range (e. g. parked pallets). If this can not be excluded, place (only for adjustment matter) an object at the appropriate location. Then repeat this adjustment step. After finishing the adjustment this temporal object should be removed.

- For optimal setting, now turn the sensitivity adjuster to the middle position between the positions A and B.

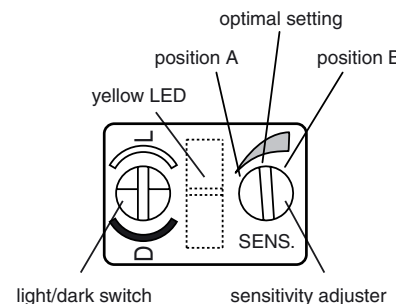

Laser notice laser class 1

- The irradiation can lead to irritation especially in a dark environment. Do not point at people!
- Maintenance and repairs should only be carried out by authorized service personnel!
- Attach the device so that the warning is clearly visible and readable.
- The warning accompanies the device and should be attached in immediate proximity to the device.
- Caution – Use of controls or adjustments or performance of procedures other than those specified herein may result in hazardous radiation exposure.