



**Model Number**

**OMT50-R101-2EP-IO-0,3M-V1**

Distance sensor  
with fixed cable and M12 connector, 4-pin

**Features**

- Miniature design with versatile mounting options
- Space-saving distance sensors in small standardized design
- Multi Pixel Technology (MPT) - exact and precise signal evaluation
- IO-link interface for service and process data

**Product information**

The miniature optical sensors are the first devices of their kind to offer an end-to-end solution in a small single standard design — from thru-beam sensor through to a distance measurement device. As a result of this design, the sensors are able to perform practically all standard automation tasks.

The DuraBeam laser sensors are durable and can be used in the same way as a standard sensor.

The use of Multi Pixel Technology gives the standard sensors a high level of flexibility and enables them to adapt more effectively to their operating environment.

**Dimensions**

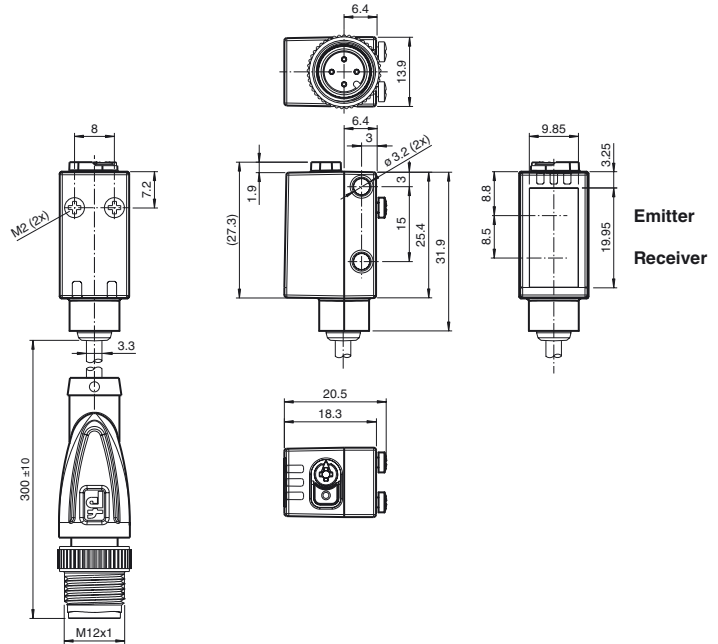

**Electrical connection**

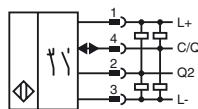

**Pinout**

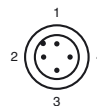

Wire colors in accordance with EN 60947-5-2

- 1 | BN (brown)
- 2 | WH (white)
- 3 | BU (blue)
- 4 | BK (black)

**Indicators/operating means**

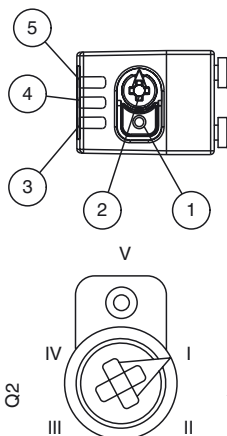

1	TEACH-IN button
2	Mode rotary switch
3	Switch output indicator Q2
4	Switch output indicator Q1
5	Operating indicator

I	Switch output 1 / switch point B
II	Switch output 1 / switch point A
III	Switch output 2 / switch point A
IV	Switch output 2 / B
V	Keylock

Release date: 2018-12-17 14:08 Date of issue: 2018-12-17 267075-100203\_eng.xml

**Technical data****General specifications**

Measurement range	20 ... 50 mm
Reference target	standard white, 100 mm x 100 mm
Light source	LED
Light type	modulated visible red light
LED risk group labelling	exempt group
Angle deviation	max. +/- 1.5 °
Diameter of the light spot	approx. 4 mm at a distance of 50 mm
Angle of divergence	4 °
Ambient light limit	EN 60947-5-2 : 30000 Lux
Resolution	0.01 mm

**Functional safety related parameters**

MTTF <sub>d</sub>	600 a
Mission Time (T <sub>M</sub> )	20 a
Diagnostic Coverage (DC)	0 %

**Indicators/operating means**

Operation indicator	LED green: constantly on - power on flashing (4Hz) - short circuit flashing with short break (1 Hz) - IO-Link mode
Function indicator	LED yellow: constantly on - switch output active constantly off - switch output inactive
Control elements	Teach-In key
Control elements	5-step rotary switch for operating modes selection

**Electrical specifications**

Operating voltage	U <sub>B</sub>	10 ... 30 V DC
Ripple		max. 10 %
No-load supply current	I <sub>0</sub>	< 25 mA at 24 V supply voltage
Protection class		III

**Interface**

Interface type	IO-Link ( via C/Q = pin 4 )
Device profile	Smart Sensor
Transfer rate	COM 2 (38.4 kBaud)
IO-Link Revision	1.1
Min. cycle time	3 ms
Process data width	Process data input 3 Byte Process data output 2 Bit
SIO mode support	yes
Device ID	0x110901 (1116417)
Compatible master port type	A

**Output**

Switching type	The default setting is: C/Q - Pin4: NPN normally open, PNP normally closed, IO-Link Q2 - Pin2: NPN normally open, PNP normally closed	
Signal output	2 push-pull (4 in 1) outputs, short-circuit protected, reverse polarity protected, overvoltage protected	
Switching voltage	max. 30 V DC	
Switching current	max. 100 mA , resistive load	
Usage category	DC-12 and DC-13	
Voltage drop	U <sub>d</sub>	≤ 1.5 V DC
Response time		2 ms

**Conformity**

Communication interface	IEC 61131-9
Product standard	EN 60947-5-2

**Measurement accuracy**

Temperature drift	20 μm/K
Warm up time	5 min
Repeat accuracy	≤ 0.15 mm
Linearity error	± 0.3 mm

**Ambient conditions**

Ambient temperature	10 ... 60 °C (50 ... 140 °F)
Storage temperature	-40 ... 70 °C (-40 ... 158 °F)

**Mechanical specifications**

Housing width	13.9 mm
Housing height	41.4 mm
Housing depth	18.3 mm
Degree of protection	IP67 / IP69 / IP69K
Connection	300 mm fixed cable with M12 x 1, 4-pin connector
Material	
Housing	PC (Polycarbonate)
Optical face	PMMA
Mass	approx. 17 g
Cable length	0.3 m

**Accessories****V31-GM-2M-PUR**

Female cordset, M8, 4-pin, PUR cable

**V31-WM-2M-PUR**

Female cordset, M8, 4-pin, PUR cable

**IO-Link-Master02-USB**

IO-Link master, supply via USB port or separate power supply, LED indicators, M12 plug for sensor connection

Other suitable accessories can be found at [www.pepperl-fuchs.com](http://www.pepperl-fuchs.com)

**Approvals and certificates**

UL approval

E87056 , cULus Listed , class 2 power supply , type rating 1

**Preferences****Teach-In:**

You can use the rotary switch to select the relevant switching threshold A and/or B for teaching in for switch signal **Q1** or **Q2**.

The yellow LEDs indicate the current state of the selected output.

To store a threshold value, press and hold the "TI" button until the yellow and green LEDs flash in phase (approx. 1 s). Teach-In starts when the "TI" button is released.

Successful Teach-In is indicated by alternating flashing (2.5 Hz) of the yellow and green LEDs.

An unsuccessful Teach-In is indicated by rapidly alternating flashing (8 Hz) of the yellow and green LEDs.

After an unsuccessful Teach-In, the sensor continues to operate with the previous valid setting after the relevant visual fault signal is issued.

Different switching modes can be defined by teaching in the relevant distance measured values

for the switching thresholds A and B:

Single point mode:

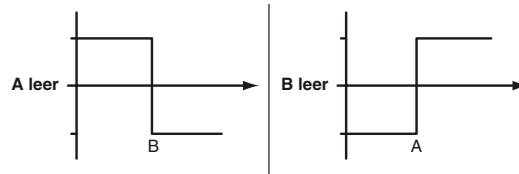

Window mode:

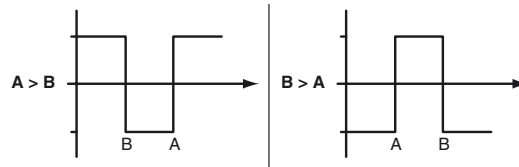

Every taught-in switching threshold can be retaught (overwritten) by pressing the „TI“ button again.

Pressing and holding the "TI" button for > 4 s completely deletes the taught-in value. The yellow and green LEDs go out simultaneously to indicate that this procedure has been completed. Successful resetting is indicated by alternating flashing (2.5 Hz) of the yellow and green LEDs.

**Resetting to Factory Default Settings**

Press the „TI“ button for > 10 s in rotary switch position ‚O‘ to reset to factory default settings. The yellow and green LEDs go out simultaneously to indicate the resetting.

Resetting process starts when the "TI" button is released and is indicated by the yellow LED. After the process the sensor works with factory default settings, immediately.

OMT:

- Factory default settings switch signal Q1:  
Switch signal active, window mode
- Factory default settings switch signal Q2:  
Switch signal active, window mode

OQT:

- Factory default settings switch signal Q1:  
Switch signal active, BGS mode (background suppression)
- Factory default settings switch signal Q2:  
Switch signal active, BGS mode (background suppression)

**Configuration via IO-Link interface****Setting different operating modes via the IO-Link interface**

The devices are equipped with an IO-Link interface as standard for diagnostics and parameterization tasks to ensure optimum adjustment of the sensors to the relevant application.

**Single point mode operating mode (one switch point):**

- "Detection of objects irrespective of type and color in a defined detection range. Objects in the background are suppressed.
- "The switch point corresponds exactly to the set point.

**Window mode operating mode (two switch points):**

- Detection of objects irrespective of type and color in a defined detection range. Reliable detection when object leaves the detection range.
- Window mode with two switch points.

**Center window mode operating mode (one switch point):**

- Detection of objects irrespective of type and color in a defined detection range. Sets a defined window around a given object. Objects outside

Refer to "General Notes Relating to Pepperl+Fuchs Product Information".

Pepperl+Fuchs Group  
www.pepperl-fuchs.com

USA: +1 330 486 0001  
fa-info@us.pepperl-fuchs.com

Germany: +49 621 776 4411  
fa-info@de.pepperl-fuchs.com

Singapore: +65 6779 9091  
fa-info@sg.pepperl-fuchs.com

this window are not detected.

- Window mode with one switch point.



### Two point mode operating mode (hysteresis operating mode):

- Detection of objects irrespective of type and color between a defined switch-on and switch-off point.

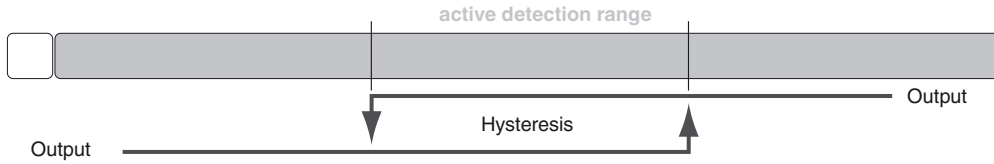

Inactive operating mode:

- Evaluation of switching signals is deactivated.

The associated IODD device description file can be found in the download area at [www.pepperl-fuchs.com](http://www.pepperl-fuchs.com).